



Uniden®

iGO CAM 90/90R

**Accident CAM
Vehicle Recorder**



For more exciting new products please visit our website:
Australia: www.uniden.com.au



OWNER'S MANUAL



Important Safety Instructions



NOTE

Uniden does not represent this product to be waterproof. Do not expose this product to Rain or Moisture.



NOTE

This product is intended for use in a motor vehicle. Don't install the device where it will block the driver's view of the road (including the mirrors!) or the deployment of the airbag.



NOTE

Keep your attention on the road! Don't try to operate or focus on any device while driving. If you have to concentrate on a device, pull off the road for a few minutes.



NOTE

Ensure that the camera lens is kept clean and there is nothing blocking the lens.



NOTE

Don't leave the device in direct sunlight for a long period of time or where the temperature could go above 60°C.



NOTE

You should examine, check and/or verify the device at least once a month including the associated SD card, to ensure the recording are working properly.



NOTE

Never attempt to disassemble, repair or make any modifications to your device.



Contents

Important Safety Instructions	2
What's In The Box.....	4
Make Sure These Items Arrived in the Box	4
Controls & Indicators	5
Installation	7
Location	7
Installing the Front Camera	7
Installing the Rear Camera	8
GPS Reception Information	8
Operation	9
Micro SD Card	9
Power Information	10
Power On	10
Power Off	10
Record Mode	11
Menu Settings	12
Photo Mode	16
Playback Mode	16
Uniden Player	17
Using the App	18
Troubleshooting	20
Specification	21
Warranty	22



What's In The Box

Make Sure These Items Arrived in the Box

iGo Cam 90/90R includes

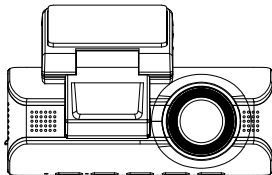

**iGO CAM 90/90R with
GPS Magnetic Mount**

- Car Cigarette Charger
- Slide Cover with 3M Sticker
- Windscreen Protective Film

iGo Cam 90R includes

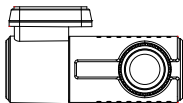

Rear Camera (RC90)



6m Rear Camera Cable

- If any item is missing or damaged, contact your place of purchase immediately. ***Never use damaged products!***
- Internal camera (IC90) available as optional accessories.
- Need help? Get answers at our website:
www.uniden.com.au for Australian model.

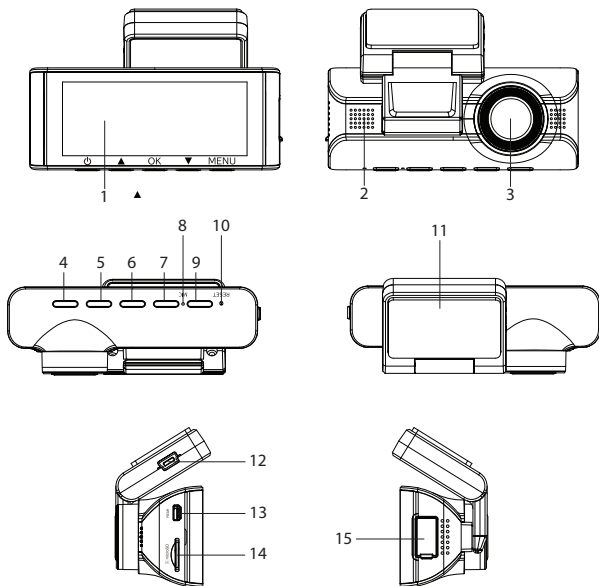

Controls & Indicators

Front Camera

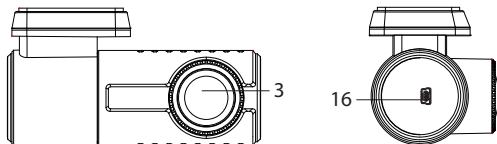

Rear Camera



Ref	Component	Description
1	LCD Screen	
2	Speaker	
3	Camera Lens	
4		Press & hold for 2 seconds to turn power on. Press & hold for 3 seconds to turn power off. Switch the display on/off.
5		Press to turn on/off audio recording. In Menu list, press to shift to the previous selection.
6	OK	Press to start or stop video recording. Press to confirm a selection in the Menu. Press to confirm a change in the settings. Press to take snapshot in photo mode.
7		Press to change camera viewing screen when internal/rear camera is connected. Press and hold to switch the Wi-Fi access point on. In Menu list, press to shift to the next selection.
8	MIC	Records sound.
9	M	Press to open the Settings Menu. Press to manually lock the current recording file while recording. Press and hold to switch between Record, Picture and Playback mode when the device is not recording.
10	Reset	If the device fails to operate properly, try resetting the device. Press the reset button by using a fine pen or paperclip.
11	GPS Module	
12	Mini USB Port	Insert DC car charger mini USB cable.
13	Rear Camera Port	Connect the rear camera connector cable (not included with iGo Cam 90/90R) . Please check label.
14	Micro SD Card Slot	Insert micro SD Card (up to 128GB min Class U3)
15	Internal Camera Port	Connect the internal/cabin camera. Internal camera is sold separately.
16	Rear Camera Output	Connect the rear camera connector cable (not included with iGo Cam 90/90R). Please check label.

Installation

Location

To have a better view, try to install the front camera at the center of the windshield. Make sure the lens is located in a place where the windshield is clean to ensure the view is clear. The recommended rear camera installation location is dead centre of the rear windshield.

Make sure the device is not installed in a place where it will interfere with the airbag. Make sure the GPS will not be obstructed by the windshield's sun control film (window tint).

Installing the Front Camera

1. Slide the sticker mount bracket into the device bracket slot and make sure it fits tightly.
2. Clean the area you desire to have the dash cam placed before sticking the device.
3. Peel off the sticker protective film from the 3M sticker on the GPS module.
4. Press and apply force on the mount onto the windshield behind the rear-view mirror.
5. Arrange and hide the cables to avoid obstruction for the driver's view.
6. Adjust the viewing angle of the camera. We recommend the camera should point slightly downwards $\sim 10^\circ$ below eye level.



NOTE

Do not install the product in a location where it can obstruct the driver's field of vision.



Installing the Rear Camera (for iGoCam 90R)

Always check the label on the rear camera cable before connecting the camera to the rear camera and front camera. This is to ensure the cable is connected to the corresponding connector port. Otherwise, the rear camera video feed will not display on the front camera screen.

1. Peel off the sticker protective film from the 3M sticker on the rear camera.
2. Mount the rear camera and apply force on the mount onto the centre rear of the windshield.
3. Check the label on the rear camera cable before connecting one end to the rear camera and the other end to the front camera.
4. Arrange and hide the cables to avoid obstruction for the driver's rear view.
5. Adjust the viewing angle of the camera. We recommend the camera should point slightly downwards $\sim 10^\circ$ below eye level.

When the rear camera is connected to the front camera and it is currently powered on, the rear camera will be displayed in the right side of the LCD screen. The recording resolution for the rear camera is 1080P.



NOTE

Please ensure the rear camera connection cable is connected/ disconnected when the device power is off or it will damage the product.



GPS Reception information

Surroundings with tall buildings, tunnels or poor weather conditions may result in poor GPS reception or even lose GPS signal. Over-tinting or a rain sensor on the windshield can affect GPS reception.

If the signal is unstable even when you are driving, please try changing the installation spot of your dash camera. For the first time use, it takes about 15~20 minutes to get GPS signal, and after that, it normally takes about 3 minutes.



NOTE

Sticker mount is difficult to remove after it is installed and will not stick well on a curved/textured or wet surface.



Operation

Micro SD Card



NOTE

A compatible micro SD card (not supplied) has to be inserted before you start using the unit. Ensure that the unit is turned off before inserting or removing the micro SD card.

The device can support micro SDHC cards (High Capacity SD) or SDXC cards (Extended Capacity SD) up to 128GB in capacity. A micro SD card of at least 16GB capacity and minimum speed of Class U3 is required.

Insert a formatted micro SD card gently in the slot at the side of the unit. To remove the card from the slot, press the edge of the micro SD card inwards for it to pop out and then pull it out of the slot.

It is important to format the micro SD card before using it, so as to avoid any damage to the files created on iGO CAM 90/90R.

Uniden only recommends using good quality MLC/SLC micro SD cards. Please ensure that the SD card used is rated for Dash Cam use.

Video Storage Capacity

Refer to the table below for reference for the recording time for different card capacity and some of the recording resolution.

Resolution	16GB	32GB	64GB	128GB
Single Channel Recording (Front camera only)				
2160P	40 mins	80 mins	160 mins	320 mins
1440P	45 mins	90 mins	180 mins	360 mins
1080P	55 mins	110 mins	220 mins	440 mins
Dual Channel Recording (Front and Rear camera)				
2160P + 1080P	35 mins	70 mins	140 mins	280 mins
1440P + 1080P	40 mins	80 mins	160 mins	320 mins
1080P + 1080P	50 mins	100 mins	200 mins	400 mins
Triple Channel Recording (Front , Rear and Internal camera)				
1440P + 1080P + 1080P	35 mins	70 mins	140 mins	280 mins
1080P + 1080P + 1080P	45 mins	90 mins	180 mins	360 mins

Power Information

The device is designed mainly for in-vehicle use, drawing on vehicle power or the vehicle battery when using the Hard Wire Kit (HWK-2). The iGO CAM 90/90R has an in-built high quality, long life supercapacitor. It provides enough backup power to ensure any recording in progress is stored safely before shutting the camera off.

Power On



NOTE

When connected to a car charger with power, the device will automatically power on and start recording.

1. Connect the DC car adaptor to the power connector USB port found on the device.
2. Connect the other end of the DC car adaptor to your car's cigarette lighter.
3. The device will power on automatically when the car supplies the power to the device.
4. The red dot on the screen will start flashing and recording starts automatically.

At other times, press and hold the power button for at least 2 seconds.



NOTE

Be sure insert the SD card before powering up the device. Format the SD card before you start recording for the first time.

Power Off

When the car's engine is turned off, the device will automatically turn off in a few seconds.

At other times, press and hold the power button for at least 3 seconds to turn off the device. Do not eject the SD card immediately to prevent damage to the last recorded file.

If you wish to switch the device back on, press and hold the power button for at least 2 seconds.



NOTE

Only use the DC car adaptor that comes with your device. Any other adaptor might damage the device.



Record Mode



NOTE

To record a video, ensure that a valid micro SD card (not supplied) is inserted in the given slot. Also note, that inserting/removing the SD card when the device is recording causes the device to shutdown and in worst case malfunction.

Using the iGO CAM 90/90R you can record videos.

Press and hold the **M** button to switch between Record, Picture and Playback modes.

Recording

When connected to a car charger with power, the unit automatically goes into the record mode and starts recording.

A flashing red dot icon and a recording timer indicates that the device is recording. To stop recording, press OK and the red dot disappears, indicating that the recording has stopped.

Protect the Current Recording

While recording, if you want to lock the current recordings, then press the **M** button. Those recordings have been locked and will not be overwritten by normal video recordings.

This also applies when the G-Sensor registers an impact while recording.

Rear Camera

Rear Camera helps you capture rear footages. Insert the rear camera cable into the front camera and the rear camera. The footage from the rear camera should be visible on the screen.

Always check the label on the rear camera cable to ensure the cable is connected to the corresponding connector port. Otherwise, the rear camera video feed will not display on the front camera screen.



Menu Settings



NOTE

Please note, you cannot access the Menu Settings while the device is recording. To access the Menu settings, you will need to stop recording by pressing the **OK** button.

Press **M** button to open the Menu Settings. Press **M** once more to exit from the Menu settings or return to previous page. Otherwise press and hold **M** to open

Press the relevant UP and DOWN keys to scan through the options, under each menu setting. Press OK to select the required option.

Main Menu	Setting	Description
Recording	Video Resolution	Set the recording resolution for the front camera. The options available are: 3840x2160P (in single and twin channel recording only), 2560x1440P and 1920x1080P. Higher resolutions will give you a sharper image, but take up more memory on the card. The rear camera and internal camera resolution is fixed at 1080P.
	Loop Recording	Use this option to set the length of each video clip. If you choose the option 'Off' then the recorder will not loop record and the files will not be overwritten on the micro SD card.
	Audio Recording	Use this setting to enable or disable audio recording. The microphone icon on the live view screen indicates yellow when the audio recording is turned on.
	Time Lapse Recording	Time Lapse setting helps you compress a long recording to just under a few seconds. By default, the option is turned off. The options available are Off, 5 fps, 2 fps and 1 fps. For example, if you opt for 1 fps, then an image is captured every 1 second. The captured images are then stitched together to playback in 30 fps.

Recording	Mirror Rear Image	Enable to display in mirrored image for the rear and internal camera. Disable to display in real image for rear and internal camera. Recordings are recorded in real image.
	Motion Detection	Enable this setting to allow the unit to record only when only the front camera detects movement.
	WDR	Enable/disable the Wide Dynamic Range (WDR) feature to improves the overall exposure throughout your entire image.
	Anti-Flicker	Change depending on the electrical power frequency in your area (Default setting is 50Hz and you may not have to change this setting).
	G Sensor	This functions helps protect/lock video files in case of a sudden impact/collision. You can change the sensitivity level of the G-sensor.
	Exposure	Set the brightness sensitivity for better effect in different lighting condition
Playback	Normal Recording	Normal video recordings are save in this folder.
	Event Recording	Locked/event recordings are save in this folder.
	Photo	All the snapshots are save in this folder.
	Return to the folder selection and press and hold M to exit.	
Parking Mode		<p>Parking mode only works with the optional Hard Wire Kit (HWK-2). The unit must have sufficient external power supplied in order to record in parking mode.</p> <p>Parking Guard: This mode turns on the unit if it detects impact and will record for 60 seconds.</p> <p>Parking Monitor: Once the ACC current is cut off, the unit will start time-lapse recording (1 fps and playback in 30fps).</p>

Date & Time		Set the date, time and the date display format.
Safety	Camera Alert	Set the alerts distance when there is a fixed Speed/Red Light/Red Light-Speed or Average Speed Camera.
	Viewing Mode	Choose to either have Live view or the speedometer displayed on the LCD.
	Fatigue Reminder	Set alert timer to periodically reminding you to take a break before continuing to drive.
Wi-Fi		Turn on the WiFi access point and display the SSID and password for App data transfer or view recorded files. Wi-Fi access point needs to be turn off before return to access the device.
Watermark	Date & Time	Opt to have the date and time displayed on the recordings.
	Speed	Opt to have the date and time displayed on the recordings.
	GPS	Opt to have the GPS coordinates displayed on the recordings.
Storage	Format SD Card Reminder	Set a reminder to remind every 15, 30, or 60 days to format your micro SD card. Before you format your micro SD card, always remember to backup whichever footage clips or photos you would like to keep before formatting, all data on the micro SD card will be deleted during the process of formatting.
	Format SD Card	Use this option to format the SD card. (All files will be permanently erased.)
	Storage Information	Indicates the capacity of the inserted micro SD card.

Settings	Key Beep	Enable or disable this feature to sound a tone or go mute when you press the keys.
	Voice Control	Enable or disable this feature to use voice commands to operate the camera
	Voice Command	List of commands recognised by the camera. Switching WiFi On/Off: "Uniden, Turn On WiFi" / "Uniden, Turn Off WiFi" Turn the display On/Off: "Uniden, Open Screen" / "Uniden, Turn Off Display" Take a snapshot: "Uniden, Take picture" Lock the current recording file: "Uniden, Lock the video"
	LCD Auto Off	Set the LCD display off timer. Off to disable this feature.
	IR LED	This setting only pops up when internal camera (not included) is connected.
	Car Plate Stamp	Edit the car plate stamp. Use the UP/DOWN keys to select a number or an alphabet. Press M to move to the next character and press OK to confirm and exit.
	Time Zone	Set the correct time zone for the GPS to get the correct time settings for the device.
	Daylight Saving Time	Enable or disable daylight saving time.
	GPS Information	To view the GPS signal connection status and strength.
	Factory Default Settings	Resets the device to factory settings. Note that restoring defaults will not erase data on the SD card.
Version	Display the device firmware version.	



Photo Mode

Press and hold the **M** button in record mode to switch to the photo mode. The photo icon will display on the top left corner of the screen.

Press the OK button to take a photo.

Playback Mode

Press and hold the **M** button in photo mode to switch to the playback mode. The device stores video and photos on the SD Card. Playback mode will allow you to review the saved videos and photos and playback the video with audio.

When in the Playback mode, select the folder and toggle the files by pressing the UP and DOWN keys to scan through the various video/image files and press OK button to play a video file.

During video playback pressing the UP or DOWN keys to select the options for. Press OK button to confirm selection.



NOTE

To return to Record Mode, press and hold the **M** button at the folder selection page. Press OK to start recording.



Uniden Player

Uniden Player allows you to view the recordings on the iGO CAM 90/90R and trace them on a map. The software is supported on Windows 7, Windows 8 and Windows 10.

Installing Uniden Player

Download the Uniden Player from the Uniden website. You may need to unzip the file using the appropriate archiving software before you can use the player. Double click on the Uniden Player icon.

Access the Recorded Files

Before playing the recorded files on the Uniden Player, ensure that you can access the files easily.

Remove the micro SD card from the recorder, and access the card (files) on the computer via a card reader (not provided).

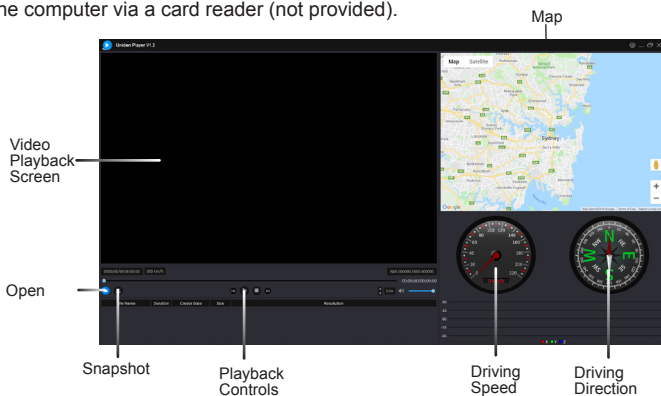

Ensure that the PC is connected to the internet to view the map screen.

1. Click on the Open icon to open the files on to the Uniden Player.
2. Click on the PLAY button (Playback Controls) to start playback.

Click on the 'Snapshot' icon to take photos of the recording. These photos will automatically save into a folder named 'screenshot'. This folder is located in the Uniden Player folder stored in your PC.



Uniden Player version is subject to change without notice. See Uniden website to download the latest GPS Player.

Using the App

iGO 90/90R App allows you to control the iGo CAM 90/90R via WiFi. You can easily preview, browsing files, playback and transfer the files in the SD card into your mobile phone. The app also allows you modify some of the device setting.

The iGo CAM 90/90R WiFi access point is off by default and you will need to turn it on to allows your mobile phone to connect to it.



NOTE

Connect your mobile phone to your iGo CAM 90/90R within a line of sight range of 10m.



NOTE

Press and hold the EMERGENCY button to turn on/off the WiFi access point.

1. Search and download the “iGoCam” App from the App Store for iOS devices or Play Store for Android devices.
2. Turn on the WiFi access point of the iGo CAM 90/90R. The SSID and the SSID and password can be found in menu settings.
3. Go to your mobile phone WiFi setting and connect to the iGo CAM 90/90R access point. The SSID usually starts with iGOCAM.... and the default password is 12345678.
4. Go back to the app and tap “Connect Device”

Camera

Tap to view live video stream from the camera, take a snapshot, and view camera settings.

Album

Tap the Album tab to view or playback downloaded photos or videos.

About

Tap to view app information and clear cache data.

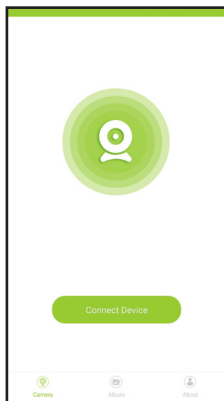

Live View

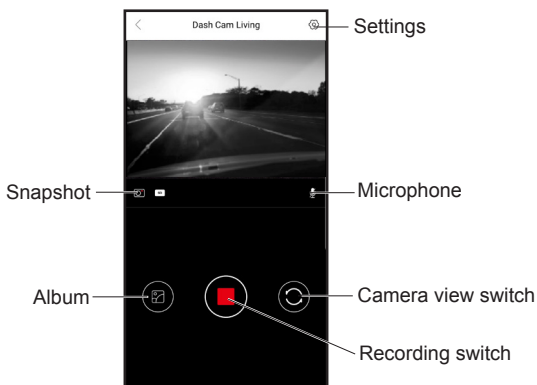

Snapshot

Take a quick snapshot.

Album

Tap the Album icon to view saved photos or videos on the SD card. You can tap to the video file to play directly or download the video file to the mobile phone storage.

Recording Switch

Start/stop the connected iGo Cam recording.

Camera View Switch

If a rear camera is connected, you can switch camera views.

Microphone

Turn on/off the connected iGo Cam camera audio recording.

Settings

Modify camera settings.



NOTE

You can change Wi-Fi SSID and password in the Camera Settings using the app.

Troubleshooting

Listed below are some of the problems and the possible solutions.

General Problems	Possible Solutions
The device cannot take photos or record videos	<ul style="list-style-type: none">• Ensure that the SD card is inserted correctly and use the device to format the SD Card.• Use the recommended type of SD card (minimum 16GB Class U3) rated for dash came use.
The device automatically stops when recording	
Video is unclear	Ensure that there are no fingerprints or dirt on the lens. Ensure that the lens is always kept clean.
Cross-stripe interference in an image	This is due to the light frequency. Change the light frequency depending on the light source.
The device crashes/ freezes	Press the 'Reset' button, with a pin, to restart the device.
SD Card Error	Please format the SD card and use recommended card only. Please make sure the SD card is recommended dash cam use.
Display turns off after a few minutes	Please check the LCD Auto Off setting and select Off.
Memory card is full	Please allow loop recording to overwrite older recording files or delete unwanted files including emergency recordings.
Camera feels warm during operation	It is normal for the camera to get warm during operation. Please bear in mind that the if the camera is exposed to high temperature for a long period of time, it might fail to boot up. Cool it down and try again.
The recorded video doesn't show mapping information on the Uniden Player.	Please ensure the PC is connected to internet.

If you still need help, visit our website or call our customer service.

Specification

Screen Size	3.19" LCD
Sensor Type	Front: 1/1.8" CMOS Rear: 1/2.7" CMOS
Recording Resolution	Front Camera: 3840x2160 (Single and twin channel recording only)/ 2540x1440/1920x1080 Rear Camera: 1920x1080 Internal Camera (Not included): 1920x1080
Frame Rate	30fps
Photo Resolution	8M/4M/3M/2M/1M
Loop Recording	Yes
Audio Recording	Yes
Viewing Angle	135°(front) / 150°(rear)
WDR	Yes
GPS	Built-In
Date and Time Stamp	Yes
Wi-Fi Access Point	Yes
Parking Mode	Yes (requires HWK-2)
G-Sensor	Yes
Video Format	MP4
Video Codec	H.264
WiFi Access Point	Yes (up to 10m line of sight)
Storage	microSD (up to 128GB), Class U3 and above
Power Input	5V 2.5A
Supercapacitor	5.5V 2.5F
Operating Temperature	-10°C ~ 60°C
Storage Temperature	-20°C ~ 70°C



Warranty

UNIDEN iGO CAM 90/90R

IMPORTANT: Satisfactory evidence of the original purchase is required for warranty service

Please refer to our Uniden website for any details or warranty durations offered in addition to those contained below.

Warrantor: The warrantor is Uniden Australia Pty Limited ABN 58 001 865 498 (“Uniden Aust”).

Terms of Warranty: Uniden Aust warrants to the original retail purchaser only that the iGO CAM 90/90R (“the Product”), will be free from defects in materials and craftsmanship for the duration of the warranty period, subject to the limitations and exclusions set out below.

Warranty period: This warranty to the original retail purchaser is only valid in the original country of purchase for a Product first purchased either in Australia or New Zealand and will expire one (1) year from the date of the original retail sale.



If a warranty claim is made, this warranty will not apply if the Product is found by Uniden to be:



- (A) Damaged or not maintained in a reasonable manner or as recommended in the relevant Uniden Owner’s Manual;
- (B) Modified, altered or used as part of any conversion kits, subassemblies or any configurations not sold by Uniden Aust;
- (C) Improperly installed contrary to instructions contained in the relevant Owner’s Manual
- (D) Repaired by someone other than an authorized Uniden Repair Agent in relation to a defect or malfunction covered by this warranty; or
- (E) Used in conjunction with any equipment, parts or a system not manufactured by Uniden.

Parts Covered: This warranty covers the Product and included accessories.

User-generated Data: This warranty does not cover any claimed loss of or damage to user-generated data (including but without limitation phone numbers, addresses and images) that may be stored on your Product.



Statement of Remedy: If the Product is found not to conform to this warranty as stated above, the Warrantor, at its discretion, will either repair the defect or replace the Product without any charge for parts or service. This warranty does not include any reimbursement or payment of any consequential damages claimed to arise from a Product's failure to comply with the warranty.

Our goods come with guarantees that cannot be excluded under the Australian Consumer Law. You are entitled to a replacement or refund for a major failure and for compensation for any other reasonably foreseeable loss or damage. You are also entitled to have the goods repaired or replaced if the goods fail to be of acceptable quality and the failure does not amount to a major failure.

This warranty is in addition to and sits alongside your rights under either the COMPETITION AND CONSUMER ACT 2010 (Australia) or the CONSUMER GUARANTEES ACT (New Zealand) as the case may be, none of which can be excluded.



Procedure for obtaining warranty service: Depending on the country in which the Product was first purchased, if you believe that your Product does not conform with this warranty, you should deliver the Product, together with satisfactory evidence of your original purchase (such as a legible copy of the sales docket) to Uniden. Please refer to the Uniden website for address details. You should contact Uniden regarding any compensation that may be payable for your expenses incurred in making a warranty claim. Prior to delivery, we recommend that you make a backup copy of any phone numbers, images or other data stored on your Product, in case it is lost or damaged during warranty service.



UNIDEN AUSTRALIA PTY LTD

Phone: 1300 366 895

Email: custservice@uniden.com.au



Uniden®

© 2021 Uniden Australia Pty Limited.
Printed in China v1.0