

Uniden®

iGO CAM 45R

**Accident CAM
Vehicle Recorder**

For more exciting new products please visit our website:
Australia: www.uniden.com.au

OWNER'S MANUAL

Important Safety Instructions



NOTE

Uniden does not represent this product to be waterproof. Do not expose this product to Rain or Moisture.



NOTE

This product is intended for use in a motor vehicle. Don't install the device where it will block the driver's view of the road (including the mirrors!) or the deployment of the airbag.



NOTE

Keep your attention on the road! Don't try to operate or focus on any device while driving. If you have to concentrate on a device, pull off the road for a few minutes.



NOTE

Ensure that the camera lens is kept clean and there is nothing blocking the lens. Do not install the product in a location where it can obstruct the driver's field of vision.



NOTE

Don't leave the device in direct sunlight for a long period of time or where the temperature could go above 60°C.



NOTE

You should examine, check and/or verify the device at least once a month including the associated SD card, to ensure the recording are working properly.



NOTE

Never attempt to disassemble, repair or make any modifications to your device.



NOTE

GPS signal may lost when surrounded with tall buildings, in a tunnel or poor weather conditions. Over-tinting or a rain sensor on the windshield can affect GPS reception.



NOTE

It may takes up to 10 minutes to get GPS signal for the first time and after that, it will normally takes up to 3 minutes. If the signal is unstable please change the installation spot.

CONTENTS

Important Safety Instructions	2
What's In The Box	4
Controls & Indicators	5
Installation	7
Operation	8
Micro SD Card	8
Power Information	8
Power On	9
Power Off	9
Record Mode	10
Photo Mode	10
Playback Mode	11
Menu Settings	12
Connecting to a PC	15
Connecting to APP	16
Troubleshooting	17
Specification	18
Warranty	19

What's In The Box

Make Sure These Items Arrived in the Box

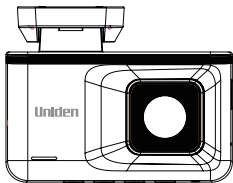

iGO CAM 45R

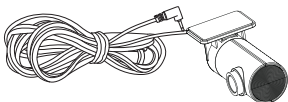

Rear Camera With Cable

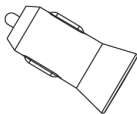

USB Car Charger

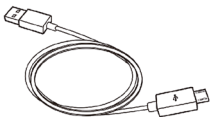

**USB Charging Cable
Only**

- **Owner's Manual**

- If any item is missing or damaged, contact your place of purchase immediately. ***Never use damaged products!***
- Need help? Get answers at our website:
www.uniden.com.au for Australian model.

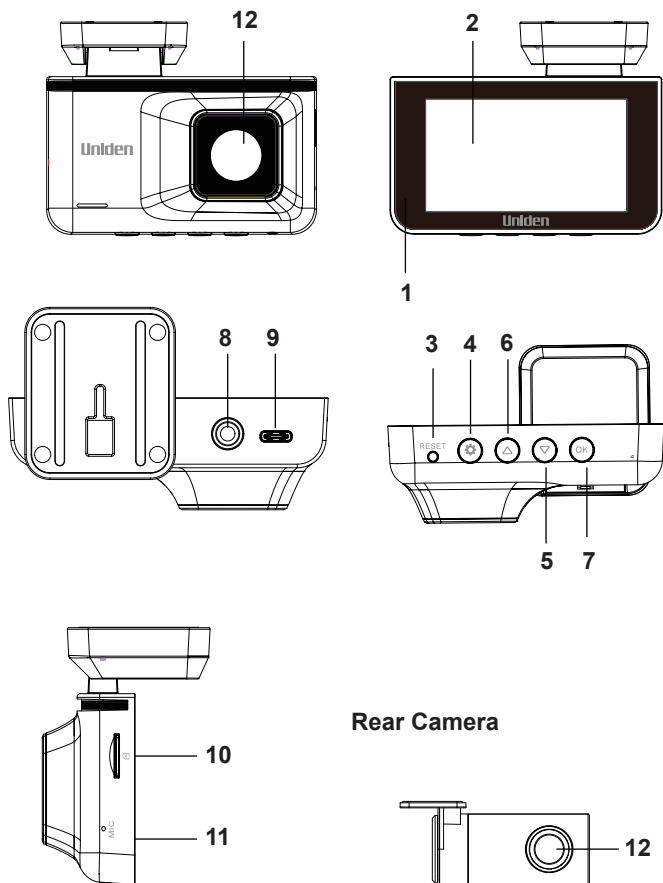

Controls & Indicators

Front Camera

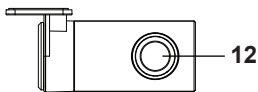

Rear Camera



Ref	Component	Description
1	LED	RED - Flashing indicates recording. BLUE - Indicates power is on, device is powering up.
2	LCD Screen	
3	Reset	If the device fails to operate, try resetting the device.
4	MENU/  Setting	Record Mode: Short press to start emergency recording. No Record Mode: Short press enter into MENU. No Record Mode: Long press 2s switch to the Record Mode, Snapshot Mode, Playback Mode.
5	DOWN 	Record Mode: Short press to On/Off Sound recording. Playback Mode: Short press toggle to next file.
6	UP 	Record Mode: Short press record front/back/picture in picture. Photo Mode: Short press switch to Front/Rear record. Playback Mode: Long press 2s switch to Rear playback record, Long press 2s again back to Front playback.
7	OK/POWER	Record Mode: Short press Start/Stop video recording. Photo Mode: Short press take Snapshot. Playback Mode: Short press Play/Stop playback video. Press & hold for 2 seconds to turn power on. Press & hold for 2 seconds to turn power off.
8	2.5mm Port (Rear)	Connect the 2.5mm port cable to the rear camera.
9	Type-C Port	Connect the Type-C cable to power on the device. Connect to PC to transfer data from the SD Card (USB data cable is not supplied).
10	Card Slot	Insert micro SD Card (up to 128GB min class 10).
11	MIC	Records sound.
12	Lens	

Installation

Location

To have a better view, try to install the front camera at the center of the windshield and the rear camera at the centre or the rear window. It can also be placed on the front windshield to record the interior of the vehicle. Make sure the lens is located in a place where the windshield is clean the window to ensure view is clear.

Make sure the device is not installed in a place where it will interfere with the safety bag. Make sure the GPS will not be obstructed by the windshield's sun control film (window tint).

Installation Steps

1. Clean the area you desire to have the cameras placed before sticking the device.
2. Slide the sticker mount bracket upwards into the back slot of the front camera bracket and make sure it fits tightly.
3. Peel off the sticker protective film of the 3M sticker of the cameras.
4. Press and apply force on the GPS sticker mount of the front camera onto the windshield behind the rearview mirror.
5. Press and apply force on the sticker mount of the rear camera onto the top center of the rear windshield.
6. Connect the front camera and rear camera with the Micro USB cable.
7. Arrange and hide the cable to avoid obstruction for the driver's view.
8. Adjust the cameras view. We recommend the camera should point slightly downwards $\sim 10^\circ$ below eye level.



NOTE

Please ensure the rear camera connection cable is connected/ disconnected when the device power is off or it will damaged the product.

Operation

Micro SD Card



NOTE

A compatible micro SD card (not supplied) is required to record and store videos and photos.

The device can support micro SDHC cards (High Capacity SD) up to 128GB in capacity. A micro SDHC card of at least 8GB capacity and minimum Class 10 speed is recommended.

Insert a formatted micro SD card gently in the slot at the side of the device. To remove the card from the slot, press the edge of the SD card inwards for it to pop out and then pull it out of the slot.

Uniden only recommends using good quality MLC/SLC micro SD cards. Please ensure that the SD card used is rated for Dash Cam use.

Video Storage Capacity

Refer to the table below for the recording capacity for different card capacity and some of the recording resolution.

Resolution	8GB	16GB	32GB	64GB	128GB
1296P	85mins	171mins	341mins	683mins	1366mins
1080P	87mins	174mins	347mins	694mins	1388mins
720P	104mins	208mins	417mins	834mins	1668mins
1080P + 1080P	43mins	87mins	174mins	347mins	694mins

Power Information

The device is designed mainly for in-vehicle use, drawing on vehicle power or the vehicle battery when using the Hard Wire Kit (HWK-1A). The iGO CAM 45R has an in-build high quality, long life supercapacitor. It provides enough backup power to ensure any recording in progress is stored safely before shutting the camera off.

Power On



NOTE

When connected to a car charger with power, the device will automatically power on and start recording.

1. Ensure the USB Charging Cable is connected to the USB car charger.
2. Plug in the USB car charger to the car's cigarette lighter port.
3. Connect the other end of the USB charging cable into the micro USB port found on top of the GPS mount bracket.
4. Connect the USB cable from the side of the GPS mount bracket into the micro USB port found on the device.
5. The device will power on automatically when the car supplies the power to the device.
6. The red dot on the screen will start flashing and recording starts automatically.

At other times, press and hold the OK/Power button for at least 2 seconds.



NOTE

Be sure insert the SD card before powering up the device. Format the SD card before you start recording for the first time.

Power Off

When the car's engine is turned off, the device will automatically turn off in a few seconds.

At other times, press and hold the OK/Power button for at least 2 seconds to turn off the device. Do not eject the SD card immediately to prevent damage to the last recorded file.

If you wish to switch the device back on, press and hold the OK/Power button for at least 2 seconds.



NOTE

Only use the USB Car Charger Adaptor and USB Charging cable that comes with your device. Any other adaptor might damage the device.

Record Mode



NOTE

To record a video, ensure that a valid micro SD card (not supplied) is inserted in the given slot. Also note, that inserting/removing the SD card when the device is recording causes the device to shutdown and in worst case malfunction.

Recording

When connected to a car charger, the device automatically goes into the record mode and starts recording.

A red dot icon and a recording timer indicates that the device is recording. To stop recording, press OK and the red dot disappears, indicating that the recording has stopped.

Press  to switch to viewing model. This will display **Front screen, Front and Rear screen, Rear screen**. Press  to enable/disable sound record.

Emergency Recording

An Emergency Recording is triggered when the Menu Button is pressed or when the G-Sensor registers an impact while recording. The emergency icon will appear on the screen. This indicates that those recordings have been locked and will not be overwritten by new video clips.

Photo Mode

When the device is not recording, press and hold the  button for 2 seconds when you see the menu to enter Photo mode. You can take a snapshot with the device.

Press the OK button to take a snapshot/photo.

Press the  button, it has two options:

1. Resolution: allow to change photo size to VGA, 1M, 2M, 3M, 5M.
2. Continuous shooting (On/Off): allow to continuing take 3 photos.

Long press the  button for 2 seconds twice, device return to Record Mode.



NOTE

If the menu is hidden, press any button at the side of the device to reveal the menu icons.

Playback Mode

In Record or Photo mode, long press the  button for 2 seconds when you see the menu to enter Playback mode. The device stores video and photos on the SD Card. Playback mode will allow you to review the saved videos and photos.

You can select Video to view Normal Record File or Emergency File to view Protected/Locked video or Photos to view all the snapshots.

After selecting the files that you wish to view in the Playback mode, toggle the files by Press the UP and DOWN button to scan through the various video/image files and press **OK** button to select/view the file.

Delete Files

During file playback, press **OK** button to play/pause the video file, press the  button to delete the selected Unlock file, or if the file is a Lock file that requires unlock this file (ie. **Unlock One**) under Protection setting and then delete the file.

Protection Files

During file playback, press the  button to Protection the file with options **Lock One, Unlock One, Lock All, Unlock All**.

Exit the Playback Mode

Long press  button for 2 seconds to switch to Record Mode or Photo Mode.

Menu Settings





NOTE

Please note, you cannot access MENU when the device is recording. To access the Menu, you will need to stop recording by pressing OK.

In record or photo or playback mode, press the OK button to stop recording.



Then, press  button to access the video record settings, and press  button to access the function settings.



Press the relevant UP and DOWN keys to scan through the various settings and then press OK to select or confirm selection. Press  button to return and exit the Menu.

Video Settings	Description
App Download	Download Uniden DV player App from Apple or Google Play store.
Video Resolution	Set the recording resolution. The resolution is 1296P/1080P/720P for single recording. And 1080P+1080P for front and rear recording. Higher resolutions will give you a sharper image, but take up more memory on the memory card.
Viewing Mode	Choose to either have Live View or the Big speedometer displayed on the LCD screen.
Loop Recording	Use this option to set the recording duration for each file.
Time-lapse Recording	Off/8 Hours/ 12 Hours/ 24 Hours in Parking Monitor mode. After your car is turned off (ACC cut off), the dash cam will turn off. The unit record 1 FPS (frame per second) continually for 8/12/24 hours.
HDR	High Dynamic Range Off/On can improve clarity of videos.
EV Setting	Set the brightness sensitivity for better effect in different lighting condition. Range -3 ~+3.
Sound Recording	Use this setting to enable or disable audio recording
Date Stamp	Use this setting to display or hide the date and time stamp, car plate stamp and speed stamp in the recorded files.
Car Plate Stamp	Edit the car plate stamp.
G-Sensor	Use this setting to adjust the sensity of the G-Sensor. This feature detects significant or sudden movement and automatically locks the current recording.
WIFI	Connect camera to the App.
Screen Saver	Set the LCD display off timer. Off/ 30s /1 minute/2 minutes

Parking Monitor	<p>Parking mode settings will only appear when the unit powered with the optional Hard Wire Kit (HWK-1A). The unit must have sufficient external power supplied in order to record in parking mode.</p> <p>Parking Mode: After your car is turned off (ACC cut off), the dash cam will turn off.</p> <p>When sudden movement/collision (G-sensor) is detected, the unit will wake up and record events. The recording time is 60s each video. The dash cam will turn off after 60s and wait for the next movement/collision (G-sensor).</p> <p>All video recorded in Parking Mode are locked and saved with file name _SOS.</p>
Auto Power Off	Set the time duration to automatically power off the device when powered by internal battery. Off/3 Minutes/ 5 Minutes/ 10 Minutes.
Frequency	Under this setting you have the option to choose between 60Hz or 50Hz. Select the relevant option and press OK to save the setting.
Key Beep	Set the beep sound volume for each time a button is pressed.
Date & Time	Change the date and time by using the relevant UP and DOWN keys, and then press OK to confirm and move on to the next selection. Set the time zone for GPS to get the correct time setting for the device.
UTC	Setting GMT (Coordinated Universal Time) Time Zone.
Daylight Saving	Enable or disable daylight saving time.
Format SD Card	Use this option to format the SD card. (All files will be permanently erased.)
Restore Default	Resets the device to factory settings. Note that restoring defaults will not erase data on the SD card.
About	Display the device firmware version.

Connecting to a PC

The iGO CAM 45R must be connected to a PC by using a USB data cable (not supplied). The supplied USB cable is for charging and supplying power only. When the device is connected to the PC, 'USB cable' icon is displayed on the device's screen.

You can view the SD card contents on the PC. When the device is detected on the PC as an external drive, select "DCIM", then select FRONT (front camera) or REAR (rear camera) folder to view the Emergency Video (_SOS) or Normal Video (_NOR) or Photo (JPG). The emergency/locked recording files are saved with the name "_F/R_SOS" under either FRONT or REAR folder. Recordings or images arranged in folders according to the specified date.

Please note that the folder named "MISC" is a system-generated folder.

Uniden DV Player

Uniden DV Player allows you to view the recordings on the iGo CAM 45R and trace them on a map.

iGO CAM Player software is supported on Windows 7, Windows 10 and macOS. Download the correct software designated for different platform.

Installing Uniden DV Player

Download the Uniden DV Player from the Uniden website. You may need to unzip the file using the appropriate archiving software before you can use the player.

Access the Recorded Files

Before playing the recorded files on the Uniden DV Player, ensure that you can access the files easily.

Either remove the micro SD card from the recorder, and access the files on the computer via a card reader.

or

Connect one end of the USB data cable (not supplied) to the device and the other end to the USB port on your computer.



NOTE

The supplied USB cable is for charging and supplying power only. You will need a USB data cable (not supplied) for transferring videos and photos from the device to the PC.

View the Recorded Files

To view the recorded files on the Uniden DV Player:



NOTE

GPS Player version is subject to change without notice. See Uniden website to download the latest GPS Player.

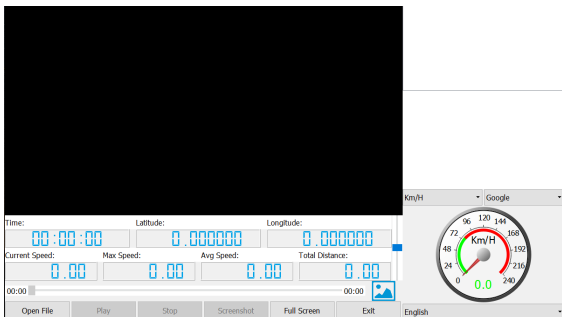

Connecting to APP

The Uniden DV app allows you to control the dash camera via WiFi. You can easily preview, browsing files, playback and download the files in the SD card into your mobile phone. The app also allows you to make changes to the device setting.

The dash camera WiFi access point is OFF by default. You can enable WiFi ON Settings.



NOTE

Connect your mobile phone to your dash camera within a line of sight range of 10m.

1. Search and download the “Uniden DV” App from the App Store for iOS devices or Play Store for Android devices.
2. Go to your mobile phone WiFi setting and connect to the camera's access point. The SSID usually starts with iGOCAM45R_.... and the default password is 12345678.
3. Go to the Uniden DV app and tap the camera.

Troubleshooting

Listed below are some of the problems and the possible solutions.

General Problems	Possible Solutions
The device cannot take photos or record videos	<ul style="list-style-type: none">• Ensure that the SD card is formatted properly and inserted correctly.• Use the recommended type of SD card (minimum 8GB Class 10)
The device automatically stops when recording	
Video is unclear	Ensure that there are no fingerprints or dirt on the lens. Ensure that the lens is always kept clean.
Dark images while recording water/sky	Adjust the exposure setting.
Cross-stripe interference in an image	This is due to the light frequency. Change the light frequency depending on the light source.
The device crashes/freezes	Press the 'Reset' button, with a pin, to restart the device.
SD Card Error	Please format the SD card and use recommended card only. Please make sure the SD card is recommended dash cam use.
Display turns off after a few minutes	Please check the LCD Auto Off setting and select Always On.
Camera feels warm during operation	It is normal for the camera to get warm during operation. Please bear in mind that the if the camera is exposed to high temperature for a long period of time, it might fail to boot up. Cool it down and try again.
The recorded video doesn't show mapping information on the Uniden DV Player.	Please ensure the PC is connected to internet. Ensure the map data file (listed as hidden file) is accompanied with the video file.
Having issues to operate the device after connecting the Uniden DV App.	Restart by pressing reset button or disconnecting the power cable and reconnecting again. Alternatively, update the latest firmware via Uniden DV App. to operate the device immediately.

If you still need help, visit our website or call our customer service.

Specification

Screen Size	3.0" LCD
Sensor Type	Front: 1/1.8" CMOS
Video Resolution	1296P/1080P/720P (front) 1080P (front) + 1080P (rear)
Photo Resolution	5M/3M/2M/1M/VGA
Dual Recording	Yes
Loop Recording	Yes
Audio Recording	Yes
Viewing Angle	140°(front) + 110°(rear)
GPS	Yes
Date and Time Stamp	Yes
Park Mode	Yes
G-Sensor	Yes
Video Codec	H264
Video Format	MOV
Audio Codec	PCM
Storage	microSD (up to 128GB), Class 10 and above
Power Input	5V 1.5A
Battery Capacity	Super Capacitor
Operating Temperature	0°C ~ 60°C
Storage Temperature	-10°C ~ 70°C
Working Humidity	10 ~ 80%

Warranty

UNIDEN iGO CAM 45R

IMPORTANT: Satisfactory evidence of the original purchase is required for warranty service

Please refer to our Uniden website for any details or warranty durations offered in addition to those contained below.

Warrantor: The warrantor is Uniden Australia Pty Limited ABN 58 001 865 498 ("Uniden Aust").

Terms of Warranty: Uniden Aust warrants to the original retail purchaser only that the iGO CAM 45R ("the Product"), will be free from defects in materials and craftsmanship for the duration of the warranty period, subject to the limitations and exclusions set out below.

Warranty period: This warranty to the original retail purchaser is only valid in the original country of purchase for a Product first purchased either in Australia or New Zealand and will expire one (1) year from the date of the original retail sale.

If a warranty claim is made, this warranty will not apply if the Product is found by Uniden to be:

- (A) Damaged or not maintained in a reasonable manner or as recommended in the relevant Uniden Owner's Manual;
- (B) Modified, altered or used as part of any conversion kits, subassemblies or any configurations not sold by Uniden Aust;
- (C) Improperly installed contrary to instructions contained in the relevant Owner's Manual
- (D) Repaired by someone other than an authorized Uniden Repair Agent in relation to a defect or malfunction covered by this warranty; or
- (E) Used in conjunction with any equipment, parts or a system not manufactured by Uniden.

Parts Covered: This warranty covers the Product and included accessories.

User-generated Data: This warranty does not cover any claimed loss of or damage to user-generated data (including but without limitation phone numbers, addresses and images) that may be stored on your Product.

Statement of Remedy: If the Product is found not to conform to this warranty as stated above, the Warrantor, at its discretion, will either repair the defect or replace the Product without any charge for parts or service. This warranty does not include any reimbursement or payment of any consequential damages claimed to arise from a Product's failure to comply with the warranty.

Our goods come with guarantees that cannot be excluded under the Australian Consumer Law. You are entitled to a replacement or refund for a major failure and for compensation for any other reasonably foreseeable loss or damage. You are also entitled to have the goods repaired or replaced if the goods fail to be of acceptable quality and the failure does not amount to a major failure.

This warranty is in addition to and sits alongside your rights under either the COMPETITION AND CONSUMER ACT 2010 (Australia) or the CONSUMER GUARANTEES ACT (New Zealand) as the case may be, none of which can be excluded.

Procedure for obtaining warranty service: Depending on the country in which the Product was first purchased, if you believe that your Product does not conform with this warranty, you should deliver the Product, together with satisfactory evidence of your original purchase (such as a legible copy of the sales docket) to Uniden at the address shown below. You should contact Uniden regarding any compensation that may be payable for your expenses incurred in making a warranty claim. Prior to delivery, we recommend that you make a backup copy of any phone numbers, images or other data stored on your Product, in case it is lost or damaged during warranty service.

UNIDEN AUSTRALIA PTY LTD

Phone: 1300 366 895

Email: custservice@uniden.com.au

Uniden[®]

© 2024 Uniden Australia Pty Limited.
v1.6