

Uniden®

iGO CAM 70R

**Accident CAM
Vehicle Recorder**

For more exciting new products please visit our website:
Australia: www.uniden.com.au

OWNER'S MANUAL

Important Safety Instructions



NOTE

Uniden does not represent this product to be waterproof. Do not expose this product to Rain or Moisture.



NOTE

This product is intended for use in a motor vehicle. Don't install the device where it will block the driver's view of the road (including the mirrors!) or the deployment of the airbag.



NOTE

Keep your attention on the road! Don't try to operate or focus on any device while driving. If you have to concentrate on a device, pull off the road for a few minutes.



NOTE

Ensure that the camera lens is kept clean and there is nothing blocking the lens. Do not install the product in a location where it can obstruct the driver's field of vision.



NOTE

Don't leave the device in direct sunlight for a long period of time or where the temperature could go above 60°C.



NOTE

You should examine, check and/or verify the device at least once a month including the associated SD card, to ensure the recording are working properly.



NOTE

Never attempt to disassemble, repair or make any modifications to your device.



NOTE

GPS signal may lost when surrounded with tall buildings, in a tunnel or poor weather conditions. Over-tinting or a rain sensor on the windshield can affect GPS reception.



NOTE

It may takes up to 10 minutes to get GPS signal for the first time and after that, it will normally takes up to 3 minutes. If the signal is unstable please change the installation spot.

CONTENTS

Important Safety Instructions	2
What's In The Box	4
Controls & Indicators	5
Installation	7
Operation	8
Micro SD Card	8
Battery Information	8
Power On	9
Power Off	9
Screen Icons	10
Record Mode	10
Record Settings	10
Photo Mode	10
Playback Mode	13
Menu Settings	13
General Settings	14
Connecting to a PC	15
Geotagged Video	15
SpecialFeatures.....	17
UsingtheApp.....	18
Troubleshooting	20
Specification	21
Warranty	22

What's In The Box

Make Sure These Items Arrived in the Box

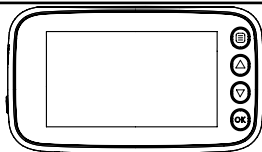

iGO CAM 70R

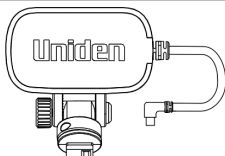

**GPS Sticker
Mount Bracket**



Rear Camera

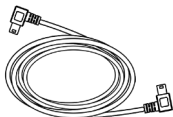

6M Rear Camera Cable



USB Car Charger

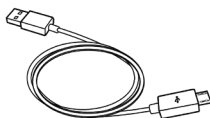

USB Charging Cable

- **Owner's Manual**

- If any item is missing or damaged, contact your place of purchase immediately. ***Never use damaged products!***
- Need help? Get answers at our website:
www.uniden.com.au for Australian model.

Controls & Indicators

Front Camera

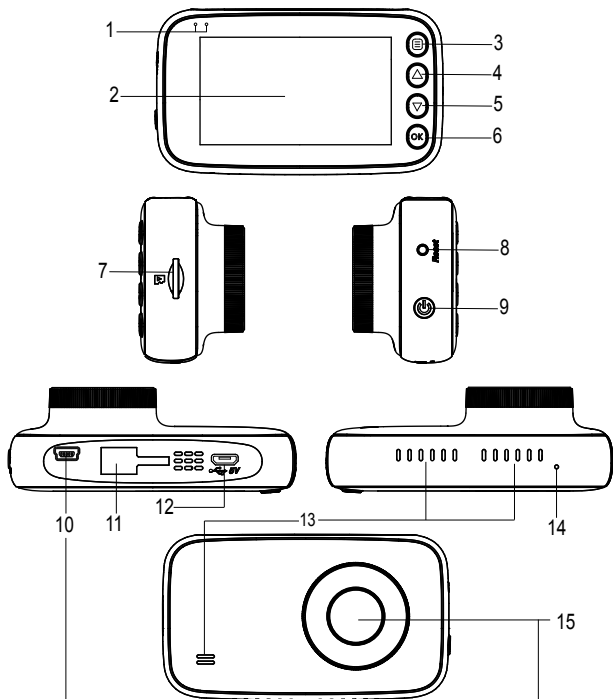

Rear Camera

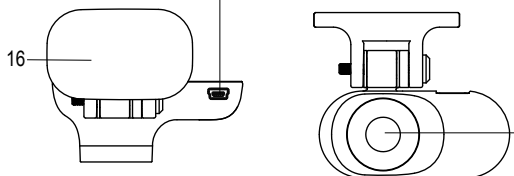

Ref	Component	Description
1	LED	RED - Flashing indicates recording. BLUE - Indicates charging battery.
2	LCD Screen	
3	MENU	Record Mode: Start emergency recording when recording/Enter Settings menu when not recording. Photo Mode: Enter Settings menu. Playback Mode: Return to previous screen/mode.
4	UP ▲	Record Mode: Enter Photo mode. Photo Mode: Take a snapshot. Playback Mode: Toggle to previous file/Delete.
5	DOWN ▼	Record Mode: Mute or unmute the Mic when recording/Enter Playback mode. Photo Mode: Enter Record mode. Playback Mode: Toggle to next file.
6	OK	Record Mode: Start/Stop video recording. Photo Mode: Enter Record mode. Playback Mode: Confirm Selection/Play/Pause.
7	Card Slot	Insert micro SD Card (up to 128GB min class 10).
8	Reset	If the device fails to operate, try resetting the device. Press the reset button using a fine pen or paperclip.
9	POWER	Press & hold for 3 seconds to turn power on. Press & hold for 3 seconds to turn power off.
10	Mini USB Port	Connect the mini USB cable to the rear view camera.
11	Bracket Slot	Slot in the GPS sticker mount bracket.
12	Micro USB Port	Connect to the micro USB cable on the GPS sticker mount bracket. Connect to PC for data (SD card) transfer (USB data cable is not supplied).
13	Speaker	
14	MIC	Records sound.
15	Lens	
16	3M Sticker	Attach the rear camera onto the windshield.

Installation

Location

To have a better view, try to install the front camera at the center of the windshield and the rear camera at the centre of the rear window. It can also be placed on the front windshield to record the interior of the vehicle. Make sure the lens is located in a place where the windshield is clean to ensure the view is clear.

Make sure the device is not installed in a place where it will interfere with the airbag. Make sure the GPS will not be obstructed by the windshield's sun control film (window tint).

Installation Steps

1. Clean the area you desire to have the cameras placed before sticking the device.
2. Slide the sticker mount bracket into the front camera bracket slot and make sure it fits tightly.
3. Peel off the sticker protective film of the 3M sticker of the cameras.
4. Press and apply force on the GPS sticker mount of the front camera onto the windshield behind the rearview mirror.
5. Press and apply force on the sticker mount of the rear camera onto the top center of the rear windshield.
6. Connect the front camera and rear camera with the mini USB cable.
7. Arrange and hide the cables to avoid obstruction for the driver's view.
8. Adjust the cameras view by loosening the screw of the bracket and fasten it back. We recommend the camera should point slightly downwards $\sim 10^\circ$ below eye level.

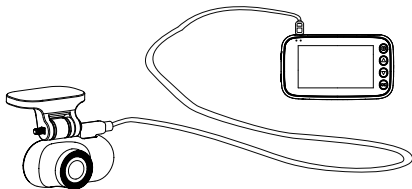

NOTE

Please ensure the rear camera connection cable is connected/ disconnected when the device power is off or it will damaged the product.

Operation

Micro SD Card



NOTE

A compatible micro SD card (not supplied) is required to record and store videos and photos.

The device can support micro SDHC cards (High Capacity SD) up to 128GB in capacity. A micro SDHC card of at least 8GB capacity and minimum Class 10 speed is recommended.

Insert a formatted micro SD card gently in the slot at the side of the device. To remove the card from the slot, press the edge of the SD card inwards for it to pop out and then pull it out of the slot.

Uniden only recommends using good quality MLC/SLC micro SD cards. Please ensure that the SD card used is rated for Dash Cam use.

Video Storage Capacity

Refer to the table below for the recording capacity for different card capacity and some of the recording resolution at 30fps.

Resolution	8GB	16GB	32GB	64GB	128GB
1080P+1080P	40 mins	80 mins	160 mins	320 mins	640 mins
2716x1524 (front)	45 mins	90 mins	180 mins	360 mins	720 mins
2304x1296 (front)	50 mins	100 mins	200 mins	400 mins	800 mins
1920x1080 (front)	60 mins	120 mins	240 mins	480 mins	960 mins

Battery Information

Although primarily designed for in-car use, the device can operate from its built-in battery for up to 10 minutes. Please note, the power usage would depend on day/night recording and resolution setting.

The device will charge the battery whenever power is detected through the USB port. The device will take about 180 minutes to charge completely.



NOTE

Please ensure that the battery is fully charged before using it for the first time. To extend the battery life, fully charge the device once every 3 months. The battery life will degrade over a period of time especially when the device is exposed to high temperature.

Power On



NOTE

When connected to a car charger with power, the device will automatically power on and start recording.

1. Ensure the USB Charging Cable is connected to the USB car charger.
2. Plug in the USB car charger to the car's cigarette lighter port.
3. Connect the other end of the USB charging cable into the micro USB port found on top of the GPS mount bracket.
4. Connect the USB cable from the side of the GPS mount bracket into the micro USB port found on the device.
5. The device will power on automatically when the car supplies the power to the device.
6. The red dot on the screen will start flashing and recording starts automatically.

At other times, press and hold the power button for at least 3 seconds.



NOTE

Be sure insert the SD card before powering up the device. Format the SD card before you start recording for the first time.

Power Off

When the car's engine is turned off, the device will automatically turn off in a few seconds.

At other times, press and hold the power button for at least 3 seconds to turn off the device. Do not eject the SD card immediately to prevent damage to the last recorded file.

If you wish to switch the device back on, press and hold the power button for at least 3 seconds.



NOTE

Only use the USB Car Charger Adaptor and USB Charging cable that comes with your device. Any other adaptor might damage the device.

Screen Icons

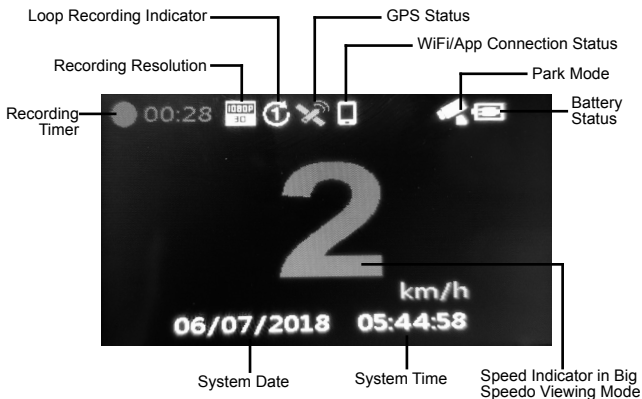

Record Mode



NOTE

To record a video, ensure that a valid micro SD card (not supplied) is inserted in the given slot. Also note, that inserting/removing the SD card when the device is recording causes the device to shutdown and in worst case malfunction.

Recording

When connected to a car charger, the device automatically goes into the record mode and starts recording.

A red dot icon and a recording timer indicates that the device is recording. To stop recording, press OK and the red dot disappears, indicating that the recording has stopped.

Emergency Recording

An Emergency Recording is triggered when the Menu Button is pressed or when the G-Sensor registers an impact while recording. The emergency icon will appear on the screen. This indicates that those recordings have been locked and will not be overwritten by new video clips.

Record Settings



NOTE

Please note, you cannot access MENU when the device is recording. To access the Menu, you will need to stop recording by pressing OK.

In record mode, press the MENU button to access the record menu settings. Press twice to display the General Settings menu. Press the relevant UP and DOWN keys to scan through the various settings and then press OK to select or confirm selection.

Press the MENU button to return and exit the Menu.



NOTE

If the menu is hidden, press any button at the right side of the device to reveal the menu icons.

Setting	Description
Video Resolution	Set the recording resolution. The maximum resolution is 2716x1524P for single recording and 1080P+1080P for dual recordings. Higher resolutions will give you a sharper image, but take up more memory in the memory card.
Screen Display	Use this setting to switch between camera display on screen when rear camera is connected.
Image Quality	Choose between the options - Super Fine, Fine and Normal - to define the detail in the recordings.
Loop Recording	Use this option to set the recording duration for each file.
Audio Recording	Use this setting to enable or disable audio recording
Stamp	Use this setting to display or hide the date and time stamp and car plate stamp.
Anti-Flicker	Under this setting you have the option to choose between 60Hz or 50Hz. Select the relevant option and press OK to save the setting.

WDR	Turn on/off the Wide Dynamic Range (WDR) feature to improves the overall exposure throughout your entire image.
Exposure	Set the brightness sensitivity for better effect in different lighting condition
Camera Alert	Turn on/off the Speed Camera/Safety Camera/Red Light Alert.
Overspeed Alert	Setup an alert to warn you when you are driving over a speed limit defined by the user.
Headlight Alert	When driving in a low light environment, it will alert you to switch on the headlight.
Forward Collision Alert	This option alerts you when it detects a possible front collision.
Lane Departure Alert	This option alerts you when the vehicle is moving into another lane.
Motion Detection	Enable this setting to allow the recorder to start recording when it detects movement. The motion detection will switch off each time the device switch off or reboot.
Park Mode	Parking Mode is off by default. You can switch it on to allow G-Sensor to detects strong vibration and start recording for the parked vehicle. The device will only turn on for about 30 seconds each time it wakes up. Parking Mode only works properly if the battery has enough power.
G-Sensor	Use this setting to adjust the sensitivity of the G-Sensor. This feature detects significant or sudden movement and automatically locks the current recording.
Viewing Mode	Choose to either have Live View or the speedometer displayed on the LCD screen.

Photo Mode

When the device is in record mode, press the UP button when you see the menu to enter Photo mode. You can take a snapshot with the device.

Press the UP button to take a snapshot.

Press the OK button to return to Record Mode.



NOTE

If the menu is hidden, press any button at the side of the device to reveal the menu icons.

Playback Mode

When the device is not recording or in Photo mode, press the Down button when you see the menu to enter Playback mode. The device stores video and photos on the SD Card. Playback mode will allow you to review the saved videos and photos.

The device will display three folders. You can select Video to view General Record File or Events to view Protected/Locked video or Photos to view all the snapshots.

After selecting the folder that you wish to view in the Playback mode, toggle the files by Press the UP and DOWN button to scan through the various video/image files and press **OK** button to select/view the file.

During file playback, press **OK** button to play/pause the video file, press the UP button the delete the selected file or DOWN button to toggle to the next file.

Press MENU button to return to previous page and press MENU button in folder selection page to return record mode.



NOTE

If the menu is hidden, press any button at the right side of the device to reveal the menu icons.

General Settings

In record mode, press the MENU button twice to access the general settings menu.

Setting	Description
Wi-Fi	Enable the device Wi-Fi hotspot for the App data transfer or viewing.
SSID	To view the device W-Fi hotspot name and password details.
Date & Time	Change the date and time by using the relevant UP and DOWN keys, and then press OK to confirm and move on to the next selection.
Time Zone	Set the time zone for GPS to get the correct time setting for the device.
Daylight Saving	Enable or disable daylight saving time.
Car Plate Stamp	Edit the car plate stamp.
Auto Power Off	Set the time duration to automatically power off the device when powered by internal battery.
LCD Auto Off	Set the LCD display off timer. Always On to keep the LCD display on.
Beep Sound	Enable the beep tone for each time a button is pressed.
Storage Information	Display the SD card total, used and free space.
Format Prompt	
Format	Use this option to format the SD card. (All files will be permanently erased.)
Default Setting	Resets the device to factory settings. Note that restoring defaults will not erase data on the SD card.
Version	Display the device firmware version.

Connecting to a PC

The iGO CAM 70R must be connected to a PC by using a USB data cable (not supplied) without the pass through the GPS bracket. The supplied USB cable is for charging and supplying power only. When the device is connected to the PC, 'USB cable' icon is displayed on the device's screen.

You can view the SD card contents on the PC. When the device is detected on the PC as an external drive, select to view the Emergency folder or Video folder or Photo folder. Select Emergency Folder to view Protected/Locked video files. Select Video folder to view General Record files and select Photo folder to view snapshots .

The park mode recording files are saved in Emergency Folder. Recordings or images arranged in folders according to the specified date.

Geotagged Video

The iGo Cam 70R comes with GPS, allowing your device to automatically sync the time with GPS. Ensure to select the correct time zone and also enable Daylight saving if needed.

GPS also allowing your videos to be geotagged. Please ensure that the GPS bracket is fitted onto the device and ensure the device is able to detect the GPS signal. You can view the recorded videos on the GPSTrackerPlayer and trace them on a map.

GPSTrackerPlayer

GPSTrackerPlayer allows you to view the recordings on the iGo Cam 70R and trace them on a map.

iGO CAM Player software is supported on Windows 7, Windows 10 and macOS. Download the correct software designated for different platform.

Installing GPSTrackerPlayer

Download the GPSTrackerPlayer from the Uniden website. You may need to unzip the file using the appropriate archiving software before you can use the player.

Access the Recorded Files

Before playing the recorded files on the GPSTrackerPlayer, ensure that you can access the files easily.

Either remove the micro SD card from the recorder, and access the files on the computer via a card reader.

or

Connect one end of the USB data cable (not supplied) to the device and the other end to the USB port on your computer.



NOTE

The supplied USB cable is for charging and supplying power only. You will need a USB data cable (not supplied) for transferring videos and photos from the device to the PC.

View the Recorded Files

To view the recorded files on the GPSTrackerPlayer, follow the steps below:

1. Start the GPSTrackerPlayer (i.e., double click on the Player icon on your desktop, or click windows start and search from the program listing). Ensure that the PC is connected to the internet to view the map screen.
2. Click on the option Open File and go to the folder that contains the recordings of the iGo Cam 70R. You may select and open all files and have it listed in the play list for easier playback.



3. The player will automatically play the first file. If you wish to play the next file, double click on the file name in the play list to start playback.

Click on the 'Screenshot' to take photos of the recording. These photos will automatically save into the PC local folder.



NOTE

GPS Player version is subject to change without notice. See Uniden website to download the latest GPS Player.

Special Features

GPS

The iGo Cam 70r comes with GPS, allowing your device to automatically sync the time with GPS. Ensure to select the correct time zone and also enable Daylight saving if needed.

GPS also allowing your videos to be geo-tagged. Please ensure that the GPS bracket is fitted onto the device ensure the device is able to detect the GPS signal. You can view the recorded videos on the GPSTrackerPlayer and trace them on a map.

Camera Alerts

The iGo Cam 70r has the ability to alerts the user when there is a fixed Speed/Red Light/Red Light-Speed or Average Speed Camera.

For this feature to work, please ensure that the Menu option, Camera Alert, in the Record Settings menu is turned on.

When the vehicle is close to any of the fixed cameras, the LCD will display the camera alert icon along with specific information. This information will include the distance from the vehicle to the camera, the specified speed limit and the current speed of the vehicle. The display is accompanied by a voice alert.

The camera alerts will not work when the device loses the GPS signal.

ADAS

ADAS includes the following 2 functions: Forward Collision Alert and Lane Departure Alert. Ensure to follow the steps listed and read the notes below to get the most out of this feature.

The ADAS detect will only function when the resolution of the front camera set to 1920x1080P 30fps. ADAS function is disabled when it connected with the APP.

Please Note:

- ADAS Alerts will be limited in poor visibility or where there is inconsistent or faded road markings.
- ADAS best work when the iGo Cam 70r is pointed 10° below eye level and the bottom of the Live View screen is recording part of the car.
- ADAS Alert features is best suited for drivers who spend time on long roads who are worried about falling asleep at the wheel – truck drivers, etc. The feature is not suited for drivers traversing short roads in city areas where deliberate lane changing is done often.
- It is NOT a substitute for careful driving.

Using the App

Uniden iGOr App allows you to control the iGo Cam 70r via WiFi. You can easily preview, browsing files, playback and transfer the files from the SD card into your mobile phone. The app also allows you modify the device settings. At other times, you can access files downloaded and saved in your mobile phone local storage.

Ensure the iGo Cam 70r WiFi hotspot is on to allow your mobile phone to connect to it.



NOTE

Connect your mobile phone to your iGo Cam 70r within a range of 3 meters.

1. Search and download the Uniden iGOr App from the App Store for iOS devices or Play Store for Android devices.
2. Turn on the WiFi hotspot of the iGo Cam 70r. You can check the SSID and password information in the General Setting Menu. The SSID usually starts with iGoCam70Rxxxx and the default password is 12345678.
3. Go to your mobile phone WiFi setting and connect to the iGo Cam 70r hotspot and open the app.



-
4. Tap Access iGo Cam to access live preview page.

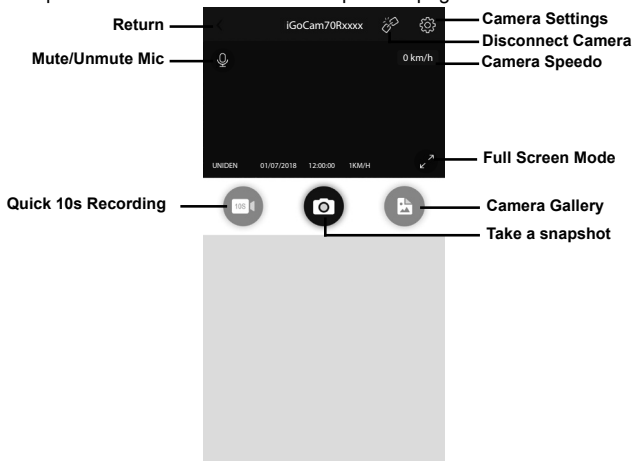

When the camera is accessed via the app, the buttons on the camera will not function. Please disconnect the camera connection in the app to continue.

Camera Gallery

You can access the files in the SD card by accessing the Camera Gallery. You can tap to the video file to play directly or download the video file to the mobile phone storage.

Local Album

You can also view and share the downloaded files by accessing Local Album in the homepage.

Troubleshooting

Listed below are some of the problems and the possible solutions.

General Problems	Possible Solutions
The device cannot take photos or record videos	<ul style="list-style-type: none">• Ensure that the SD card is formatted properly and inserted correctly.• Use the recommended type of SD card (minimum 8GB Class 10)
The device automatically stops when recording	
Video is unclear	Ensure that there are no fingerprints or dirt on the lens. Ensure that the lens is always kept clean.
Dark images while recording water/sky	Adjust the exposure setting.
Cross-stripe interference in an image	This is due to the light frequency. Change the light frequency depending on the light source.
The device crashes/freezes	Press the 'Reset' button, with a pin, to restart the device.
SD Card Error	Please format the SD card and use recommended card only. Please make sure the SD card is recommended dash cam use.
Display turns off after a few minutes	Please check the LCD Auto Off setting and select Always On.
Camera feels warm during operation	It is normal for the camera to get warm during operation. Please bear in mind that the if the camera is exposed to high temperature for a long period of time, it might fail to boot up. Cool it down and try again.
The recorded video doesn't show mapping information on the GpsTracker Player.	Please ensure the PC is connected to internet. Ensure the map data file (listed as hidden file) is accompanied with the video file.

If you still need help, visit our website or call our customer service.

Specification

Screen Size	2.7" LCD
Sensor Type	1/2.9" CMOS
Video Resolution	2716x1524/2560x1440/2304x1296/ 1920x1080/1280x720 (front) 1920x1080(rear)
Photo Resolution	4032x3024(front) / 4032x3024(rear)
Dual Recording	Yes
Loop Recording	Yes
Audio Recording	Yes
Viewing Angle	140°(front) + 110°(rear)
WDR	Yes
GPS	Yes
Date and Time Stamp	Yes
Headlight Alert	Yes
Motion Detection	Yes
Park Mode	Yes
G-Sensor	Yes
Video Format	MP4
Video Codec	H264
Audio Codec	AAC
Storage	microSD (up to 128GB), Class 10 and above
Power Input	5V 1.5A
Battery Capacity	Li-ion 320mAh
Operating Temperature	0°C ~ 60°C
Storage Temperature	-10°C ~ 70°C
Working Humidity	10 ~ 80%

Warranty

UNIDEN iGO CAM 70R

IMPORTANT: Satisfactory evidence of the original purchase is required for warranty service

Please refer to our Uniden website for any details or warranty durations offered in addition to those contained below.

Warrantor: The warrantor is Uniden Australia Pty Limited ABN 58 001 865 498 (“Uniden Aust”).

Terms of Warranty: Uniden Aust warrants to the original retail purchaser only that the iGO CAM 70R (“the Product”), will be free from defects in materials and craftsmanship for the duration of the warranty period, subject to the limitations and exclusions set out below.

Warranty period: This warranty to the original retail purchaser is only valid in the original country of purchase for a Product first purchased either in Australia or New Zealand and will expire one (1) year from the date of the original retail sale.

If a warranty claim is made, this warranty will not apply if the Product is found by Uniden to be:

- (A) Damaged or not maintained in a reasonable manner or as recommended in the relevant Uniden Owner's Manual;
- (B) Modified, altered or used as part of any conversion kits, subassemblies or any configurations not sold by Uniden Aust;
- (C) Improperly installed contrary to instructions contained in the relevant Owner's Manual
- (D) Repaired by someone other than an authorized Uniden Repair Agent in relation to a defect or malfunction covered by this warranty; or
- (E) Used in conjunction with any equipment, parts or a system not manufactured by Uniden.

Parts Covered: This warranty covers the Product and included accessories.

User-generated Data: This warranty does not cover any claimed loss of or damage to user-generated data (including but without limitation phone numbers, addresses and images) that may be stored on your Product.

Statement of Remedy: If the Product is found not to conform to this warranty as stated above, the Warrantor, at its discretion, will either repair the defect or replace the Product without any charge for parts or service. This warranty does not include any reimbursement or payment of any consequential damages claimed to arise from a Product's failure to comply with the warranty.

Our goods come with guarantees that cannot be excluded under the Australian Consumer Law. You are entitled to a replacement or refund for a major failure and for compensation for any other reasonably foreseeable loss or damage. You are also entitled to have the goods repaired or replaced if the goods fail to be of acceptable quality and the failure does not amount to a major failure.

This warranty is in addition to and sits alongside your rights under either the COMPETITION AND CONSUMER ACT 2010 (Australia) or the CONSUMER GUARANTEES ACT (New Zealand) as the case may be, none of which can be excluded.

Procedure for obtaining warranty service: Depending on the country in which the Product was first purchased, if you believe that your Product does not conform with this warranty, you should deliver the Product, together with satisfactory evidence of your original purchase (such as a legible copy of the sales docket) to Uniden at the address shown below. You should contact Uniden regarding any compensation that may be payable for your expenses incurred in making a warranty claim. Prior to delivery, we recommend that you make a backup copy of any phone numbers, images or other data stored on your Product, in case it is lost or damaged during warranty service.

UNIDEN AUSTRALIA PTY LTD

Phone: 1300 366 895

Email: custservice@uniden.com.au

Uniden[®]

© 2018 Uniden Australia Pty Limited.
Printed in PRC