

Uniden®

DASH VIEW 40R **Dash Cam** **Vehicle Recorder**

For more exciting new products please visit our website:
Australia: www.uniden.com.au

OWNER'S MANUAL

Important Safety Instructions



NOTE

Uniden does not represent this product to be waterproof. Do not expose this product to Rain or Moisture.



NOTE

This product is intended for use in a motor vehicle. Don't install the device where it will block the driver's view of the road (including the mirrors!) or the deployment of the airbag.



NOTE

Keep your attention on the road! Don't try to operate or focus on any device while driving. If you have to concentrate on a device, pull off the road for a few minutes.



NOTE

Ensure that the camera lens is kept clean and there is nothing blocking the lens.



NOTE

Don't leave the device in direct sunlight for a long period of time or where the temperature could go above 60°C.



NOTE

You should examine, check and/or verify the device at least once a month including the associated SD card, to ensure the recording are working properly.



NOTE

Never attempt to disassemble, repair or make any modifications to your device.

Contents

Important Safety Instructions	2
What's In The Box.....	4
Make Sure These Items Arrived in the Box	4
Controls & Indicators	5
Installation	7
Location	7
Installing the Camera with Protection film.....	7
Installing the Rear Camera	8
Installing the Optional Hardwiring Kit	8
Operation	9
Micro SD Card	9
GPS Reception Information	9
Power On	10
Power Off	10
Recording	11
Take Photo	11
Big Speedo	12
Go to Record Settings	12
Change Settings	14
Playback mode	15
Using the App	16
Device Settings	18
Uniden Player	22
Troubleshooting	23
Specification	24
Warranty	25

What's In The Box

Make Sure These Items Arrived in the Box



Uniden Dash View 40R
with sticker mount
bracket attached



32GB MLC High
Endurance Micro
SD Card



Cigarette Charger



Hardwiring Kit



Micro USB cable
(Charging cable only)

- Protection film
 - Sticker mount bracket
 - Owner's Manual
- If any item is missing or damaged, contact your place of purchase immediately. ***Never use damaged products!***
 - Need help? Get answers at our website: www.uniden.com.au for Australian model.

Controls & Indicators

Uniden Dash View 40R

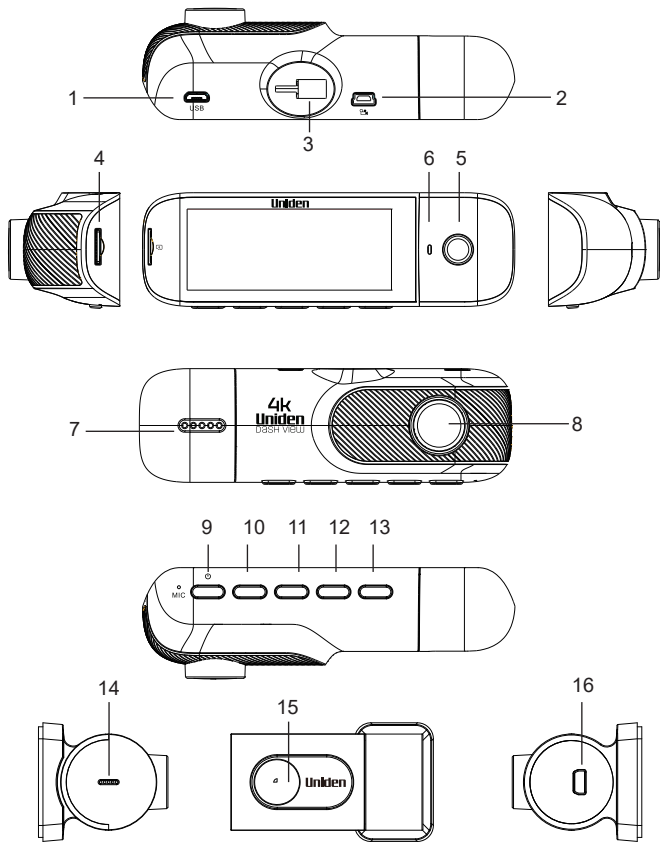

Ref	Component	Description
1	Micro USB Port	Insert DC car charger micro USB cable or the Hard wiring kit micro USB connector. Connect to PC for data (SD card) transfer.
2	Rear Camera Port	Connect to rear camera.
3	Bracket Slot	Slot in the sticker mount bracket.
4	Micro SD Card Slot	Insert micro SD Card (up to 512GB min Class 10 or above).
5	Cabin Camera	Cabin Camera Lens.
6	REC LED	Flashing RED when the device is recording.
7	Speaker	
8	Front Camera Lens	Front Camera Lens on 4K resolution.
9	Power Button	Press and hold to open ON/OFF camera.
10	Snapshot Button	Take a snapshot while recording or in standby mode.
11	Sound Record Button	Set sound recording ON/OFF.
12	Video Record Button	Start/Pause video recording.
13	Emergency Recording Button	Take emergency video recording.
14	Rear Camera Mic	Record sound.
15	Rear Camera Lens	Rear Camera Lens on 1080P resolution
16	Rear/Front Camera Port	Connect to Front Camera.



NOTE

You may also refer to the latest Owner's Manual available on the Uniden website for further information.

Installation

Location

To have a better view, try to install the camera at the center of the windshield. Make sure the lens is located in a place where the windshield is clean to ensure the view is clear.

Make sure the device is not installed in a place where it will interfere with the airbag. Make sure the GPS will not be obstructed by the windshield's sun control film (window tint).

Installing the Camera with Protection film

1. The sticker mount bracket comes pre-installed with the camera. Otherwise, slot the sticker mount bracket into the device bracket slot and make sure it fits tightly.
2. Clean the area you desire to have the dash cam placed before sticking the device.
3. Apply the Protection film to your windshield before sticking your dash camera, the protection film will make your device easier to remove from windshield. Stick your device inside the dashed line.

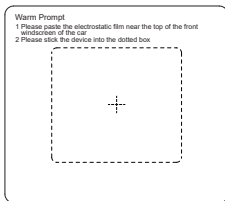

4. Peel off the 3M sticker protective film from the mount bracket.
5. Press and apply force on the mount onto the windshield behind the rear-view mirror.
6. Arrange and hide the cables to avoid obstruction for the driver's view.
7. Adjust the viewing angle of the camera by rotating the body of the camera. We recommend the camera should point slightly downwards $\sim 10^\circ$ below eye level.



NOTE

Do not install the product in a location where it can obstruct the driver's field of vision.

Installing the Rear Camera

Install the rear camera at the centre top of the rear windshield.

1. Clean the area before installation. Apply the Protection film to windshield.
2. Peel off the sticker protective film from the 3M sticker.
3. Press and apply force on the sticker mount onto the back windshield.
4. Connect the rear camera to the front camera with provided cable.
5. Arrange and hide the cables to avoid obstruction for the driver's view.
6. Adjust the viewing angle of the camera by rotating the body of the camera.
We recommend the camera should point slightly downwards $\sim 10^\circ$ below eye level.

Installing the Optional Hardwiring Kit

If you wish to use the parking mode on the camera, you will need to install the hardwiring kit provided (HWK-1A). Choose 10A-30A rated fuse slots to wire your dash cam and refer to your vehicle's manual to avoid selecting slots associated with safety features.

1. Locate the location of the fuse box in your vehicle.
2. There are 3 wires that need to be connected: connect the **Yellow** cable that goes to a constant fuse, **RED** cable that goes to an ignition-switched fuse and **BLACK** cable that goes to a metal ground bolt.

YELLOW cable connect to **BATTERY (+)**

RED cable connect to car **ACC**

BLACK cable connect to car **GROUND**

3. Connect the micro USB end of the hardwiring cable to the camera micro USB port.
4. Start your vehicle to see if it works. Arrange and hide the cables to avoid obstruction for the driver's view.

It is advisable to get a car electrician to professionally install the hardwiring kit.



NOTE

Before installing the HWK-1A kit, please ensure there is no SD Card installed on the camera unit. Only install the SD card once the HWK-1A kit is finish installing.

Operation

Micro SD Card

The device support micro SDXC cards (Extended Capacity SD) up to 512GB in capacity. A micro SD card of at least 32GB capacity and minimum speed of Class 10 or above is required. Higher speed of Class U3 is recommended.

Insert a the micro SD card gently in the slot at the side of the unit. To remove the card from the slot, please ensure the unit is powered off and press the edge of the micro SD card inwards for it to pop out and then pull it out of the slot.

It is important to format the micro SD card before using it, so as to avoid any damage to the files created on DASH VIEW 40R.

Uniden only recommends using good quality MLC/SLC Endurance micro SD cards for dash cam recording. Please check with SD card manufacturer to ensure that the SD card used is rated for Dash Cam recording.

Video Storage Capacity

Refer to the table below for reference for the recording time for different card capacity and some of the recording resolution.

Resolution	32GB	64GB	128GB	256GB	512GB
4K+1080P	84mins	168mins	336mins	672mins	1344mins
1600P+1080P+1080P	102mins	205mins	410mins	819mins	1632mins



NOTE

A compatible micro SD card has to be inserted before you start using the unit. Ensure that the unit is switched off before inserting or removing the micro SD card.

GPS Reception information

Surroundings with tall buildings, tunnels or poor weather conditions may result in poor GPS reception or even lose GPS signal. Over-tinting or a rain sensor on the windshield can affect GPS reception.

If the signal is unstable even when you are driving, please try changing the installation spot of your dash camera. For the first time use, it takes about 15~20 minutes to get GPS signal, and after that, it normally takes about 3 minutes. When GPS receiver receives a signal,  turns BLUE.



NOTE

Sticker mount is difficult to remove after it is installed and will not stick well on a curved/textured or wet surface.

Power On



NOTE

When connected to a car charger with power, the camera will automatically power on and start recording.

1. Connect the other end of the DC car adaptor to your car's cigarette lighter.
2. Connect the DC car micro USB adaptor to the power connector USB port found on the camera.
3. The camera will power on automatically when the car supplies the power to the camera.
4. The RED LED on the camera will start flashing and recording starts automatically.



NOTE

Be sure insert the SD card before powering up the device. Format the SD card before you start recording for the first time.

Power Off

When the car's engine is turned off, the device will automatically turn off in a few seconds.

Power Information

The device is designed mainly for in-vehicle use, drawing on vehicle power or the vehicle battery when using the hardware kit (HWK-1A).

The Dash VIEW 40R has an in-built high quality, long life supercapacitor. It provides enough backup power to ensure any recording in progress is stored safely before shutting the camera off.



NOTE

For the first time use, it is advisable to format the SD Card.

Recording

When connected to a car charger with power, the device will ask you to set up DATE/TIME and Day Light Saving first, then automatically goes into the record mode and starts recording.

A flashing RED led on the device indicates that the device is recording.



NOTE

To record a video, ensure that a valid micro SD card is inserted in the given slot. Also note, that inserting/removing the SD card when the device is recording causes the device to shutdown and in worst case missing recording files.

Protect the Current Recording

While recording, if you want to protect the current recordings, press the emergency recording button .

Those recordings have been locked and will not be overwritten by normal video recordings.

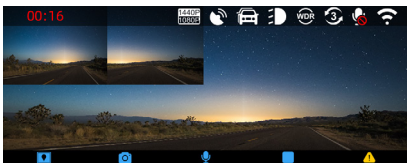

Sound Recording

Press the sound recording button  if you do not want to record sound.

The  icon will indicate that sound is not being recorded.

Take Photo

While the device is recording, you can take a snapshot by pressing the take photo button .



NOTE

If the menu is hidden, press any button at the side of the device to reveal the menu icons.

Big Speedo

If you need to switch to Big Speedo, press  button and the display will show the below image:

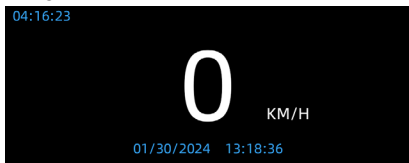



Go to Record Settings





NOTE



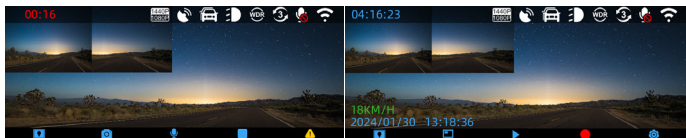























Please note that to access the Device Settings, the device required to stop recording.

If you need to adjust settings while recording, stop by pressing the  button to reveal the stop recording button . Then press the device settings button  to access the settings menu.



Press  button in stop recording mode to switch to viewing mode. This will display **PIP Front Full Screen, PIP Inside Full Screen, PIP Rear Full Screen, Front Camera, Inside Camera, Rear Camera.**

If you want to view videos or photos, simply press  button to enter Video Playback mode. For further details, refer to the **Playback Mode** instructions.

Menu Icon	Description
	App Download
	Resolution
	Loop recording
	Screen display
	Viewing Mode
	Cabin Camera
	WDR
	EV Setting
	Frequency
	G-sensor sensitivity
	Screen Saver
	Camera Alert
	Overspeed Alert
	Volume Setting
	Sound Recording
	Headlight Reminder
	Fatigue Driving Alert
	Parking Monitor
	Date/Time
	Car Plate Stamp
	Watermark
	WiFi
	Format SD Card
	Format Reminder
	Restore Default
	GPS Signal
	Memory Card Info
	About

Change Settings

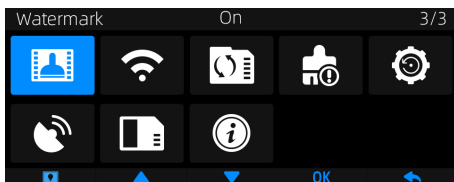
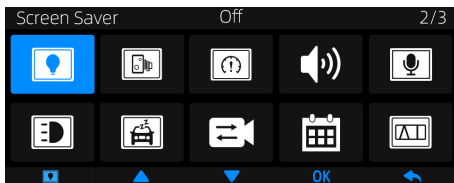
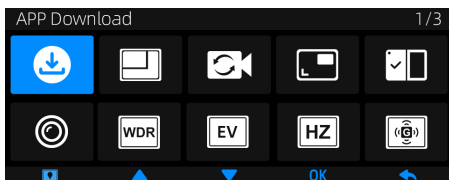

In the record menu settings, press the relevant ▲ and ▼ keys to scan through the various settings and then press OK to select or confirm selection.

Press the ◀ button to return and exit the Menu.





Playback Mode

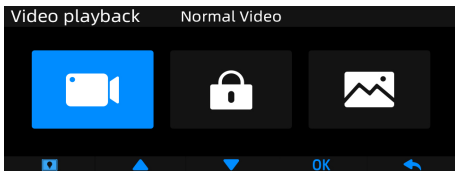

When the device is not recording or in Photo mode, press the  button to enter Playback mode. The device stores video and photos on the SD Card. Playback mode will allow you to review the saved videos and photos.

The device will display three folders. You can press  or  to select Video/Photo to view Normal Video File, Emergency File or Photo Capture.



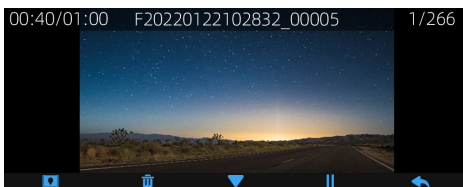

After selecting the folder that you wish to view in the Playback mode, toggle the files by Press the  and  button to scan through the various video/image files and press **OK** button to confirm, then press  to play the file.

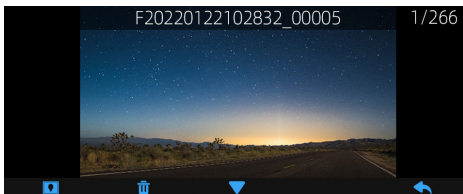

During file playback, press button to play/pause the video file, press the  button the delete the selected file or  button to toggle to the next file.



Press  button to return to previous page and press  button in folder selection page to return record mode.



NOTE

If the menu is hidden, press any button at the bottom of the device to reveal the menu icons.

Using the App

The Uniden DV app allows you to control the Dash View camera via WiFi. You can easily preview, browsing files, playback and download the files in the SD card into your mobile phone. The app also allows you to make changes to the device setting.

The Dash View camera WiFi access point is OFF by default. You can enable WiFi ON Settings.



NOTE

Connect your mobile phone to your Dash View within a line of sight range of 10m.

1. Search and download the “Uniden DV” App from the App Store for iOS devices or Play Store for Android devices.
2. Go to your mobile phone WiFi setting and connect to the camera’s access point. The SSID usually starts with DASHVIEW_.... and the default password is 12345678.
3. Go to the Dash View app and tap the camera.



NOTE

If issue arises from accessing the camera via APP for the first time, please format the SD Card.

Home Screen

When your mobile phone is connected to the camera's WiFi access point, the camera image will show on the home screen.

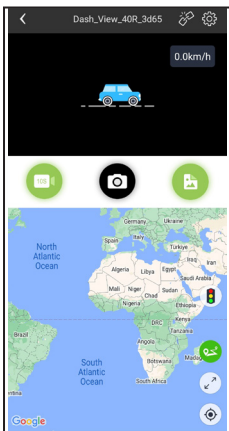

Camera is connected

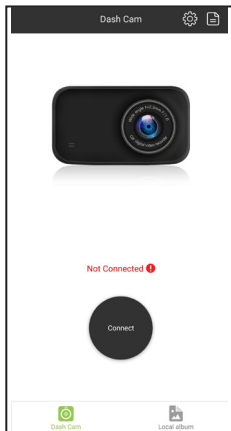

Camera is not connected

Camera

Tap to view live video stream from the camera, take a snapshot, and view camera settings.

Downloaded Video

Tap the Downloaded Video tab to view or playback downloaded photos or videos even when then the camera is not connected.



NOTE

You can change WiFi password in the Camera Settings using the app.

Device Settings



NOTE

Please note that to access the Device Settings, the device required to stop recording.

Stop the recording and tap the device settings icon to access settings menu. Any changes to the settings will take effect concurrently.

Video Settings	
Resolution	<p>Set the recording resolution for the front camera. Higher resolutions will give you a sharper image, but take up more memory on the card.</p> <p>4K+1080P 1600P+1080P 1440P+1080P 1080P+1080P</p> <p>With rear camera resolution.</p> <p>1600P+1080P+1080P 1440P+1080P+1080P 1080P+1080P+1080P</p>
Loop Recording	<p>Use this option to set the recording duration into smaller fragments that enable the device to overwrite SD Card when reach storage capacity. The duration of these recorded files will be 1 min, 3 mins and 5 mins.</p>
Viewing Mode	<p>Opt to have the live viewing and Big Speedo.</p>
Cabin Camera	<p>Turn on/off the Cabin Camera.</p>
WDR	<p>Turn on/off the Wide Dynamic Range (WDR) feature to improves the overall exposure throughout your entire image.</p>
Screen Saver	<p>Screen Saver option</p>

G-Sensor	This functions helps protect/lock video files in case of a sudden movement/collision. You can change the sensitivity level of the G-sensor. Off/Low/Medium/High.
Camera Alert	Set the alert distance when there is a Fixed Speed, Red Light or Red Light-Speed Camera.
Volume	Adjust the camera volume level. 100%/75%/50%/Off.
Audio Recording	Use this setting to enable or disable audio recording.
Headlight Alert	Turn on/off the headlight alert. Reminder driver to turn on the vehicles headlights.
Fatigue Driving Alert	Reminder driver to avoid driving tired. Off/1hour/2hours/4hours.
Anti-Flicker	Change depending on the electrical power frequency in your area.
Date/Time	Set the correct date and time. Daylight Saving option.
Daylight Saving	Enable or disable daylight saving time.
Watermark	Uniden Logo Watermark on/off.
Driver ID	Tap to edit the car plate stamp with maximise 9 digits.
WiFi	Tap to view or rename the WiFi access point name. Password: 12345678
Format Prompt	Use this option to format the SD card. 15Days/30Days/60Days/Off. Default 30Days.
Restore Factory Setting	Resets the device to factory settings. Note that restoring defaults will not erase data on the SD card.
Memory Card Information	Indicates the remaining capacity of the inserted micro SD card.
About	Display the device firmware, SN and version.

Parking Monitor

Parking mode settings will only appear when the unit powered with the optional Hard Wire Kit (HWK-1A). The unit must have sufficient external power supplied in order to record in parking mode.

Parking Mode:

When you turn off your car (ACC cut off), the dash cam will also turn off. If sudden movement or collision (detected by the G-sensor) occurs, the device will wake up and start recording events. Each video recording will last for 60 seconds. If movement or collision is still detected at the 50-second mark, the dash cam will continue recording for another 60 seconds (60s + 60s). All videos recorded in Parking Mode will be saved and locked in the Emergency File (Events File).

Exit Parking Monitor in Parking Mode:

If both collision (G-sensor) and motion are detected longer than 3s or touch any buttons, it will wake up screen and start continuously recording emergency footage for 1, 3, or 5 minutes, depending on loop recording settings. After that, it will continue recording normal video until the hardwiring kit reaches the cut-off voltage point.

Motion Detection:

When you turn off your car and the ACC cuts off, the dash cam will also turn off. However, if there is any motion detected, it will automatically wake up and start recording events. The first video recording will last for 60s.

If motion is still detected at the 50s mark for the second time, the device will continue recording for an additional 60s (60s + 60s). These recorded videos will be saved in the Normal file.

1FPS:

When you turn off your car and the ACC cuts off, the dash cam will also turn off. However, if motion is detected, the device record 1 frame per second (1FPS) continually for 10mins. If motion is still detected at 9mins50s mark for the second time, the device will continue record 1FPS for 10mins.

	<i>Exit Parking Monitor in Motion Detection and 1FPS:</i>
--	--

If both collision (G-sensor) and motion are detected longer than 3s or touch any buttons, the device will wake up screen and enter into a continuous normal loop recording mode until the hardwiring kit reaches the cut-off voltage point.

Connecting to a PC

The Dash View camera can be connected to a PC (plug the USB data cable into the micro USB port). You should prepare a data cable to connect to the PC. When the device is detected on the PC as an external drive, the normal recording video files can be found in the Normal folder. All the event recording files are stored in the Event folder.

Uniden DV Player

Uniden DV Player allows you to view the recordings on the Dash View camera and trace them on a map. The software is supported on Windows 7, Windows 8 Windows 10 and on macOS.

Installing Uniden DV Player

Download the Uniden DV Player from the Uniden website. You may need to unzip the file using the appropriate archiving software before you can use the player. Double click on the Uniden DV Player icon.

Access the Recorded Files

Before playing the recorded files on the Uniden DV Player, ensure that you can access the files easily.

Remove the micro SD card from the recorder, and access the card (files) on the computer via a card reader.

View the Recorded Files

To view the recorded files on the Uniden DV Player, follow the steps below:

1. Start the Uniden DV Player (i.e., double click on the Uniden DV Player icon on your desktop, or click windows start and search from the program listing).

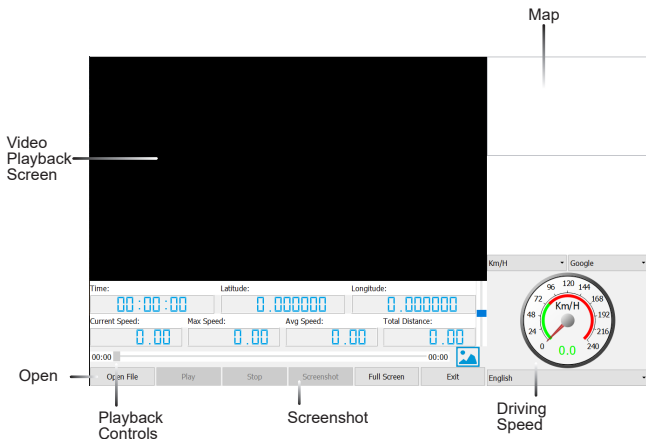

Ensure that the PC is connected to the internet to view the map screen.

2. Click on the folder icon or select disk to open the files on to the Uniden Player.

3. Click on the PLAY button (Playback Controls) to start playback.

Click on the 'Screenshot' icon to take photos of the recording. These photos will automatically save into a folder named 'Screenshot'. This folder is located in the Uniden DV Player folder stored in your PC.



NOTE

Uniden DV Player version is subject to change without notice. See Uniden website to download the latest GPS Player.

Troubleshooting

Listed below are some of the problems and the possible solutions.

General Problems	Possible Solutions
The device cannot take snapshot or record videos	<ul style="list-style-type: none">• Ensure that the SD card is formatted properly and inserted correctly.• Use the recommended type of SD card (minimum 32GB Class 10 and above)
The device automatically stops when recording	
Video is unclear	Ensure that there are no fingerprints or dirt on the lens. Ensure that the lens is always kept clean.
Cross-stripe interference in an image	This is due to the light frequency. Change the light frequency depending on the light source.
The device crashes/ freezes	Press the 'Reset' button, with a pin, to restart the device.
SD Card Error	Please format the SD card and use recommended card only. Please make sure the SD card is recommended dash cam use.
Display turns off after a few minutes	Please check the LCD Auto Off setting and select Always On.
Memory card is full	Please allow loop recording to overwrite older recording files or delete unwanted files including emergency recordings.
Camera feels warm during operation	It is normal for the camera to get warm during operation. Please bear in mind that the if the camera is exposed to high temperature for a long period of time, it might fail to boot up. Cool it down and try again.
The recorded video doesn't show mapping information on the Uniden Player.	Please ensure the PC is connected to internet.

If you still require assistance, visit our website or call our customer service.

Specification

Sensor Type	Front: 1/1.8" CMOS
Video Resolution	Front: 4K, Cabin/Rear: 1080P
Frame Rate	30fps
Loop Recording	Yes
Audio Recording	Yes
Viewing Angle	130°(front) / 140°(rear)
WDR	Yes
GPS	Built-In
Date and Time Stamp	Yes
Motion Detection	Yes
Parking Mode	Yes (requires HWK-1A)
G-Sensor	Yes
Video Format	MP4
Video Codec	H.264
Audio Codec	AAC
WiFi Access Point	2.4GHz (up to 10m line of sight)
Storage	microSD (up to 512GB), Class 10 and above
Power Input	5V 2.4A
Supercapacitor	Yes
Operating Temperature	-10°C ~ 60°C
Storage Temperature	-20°C ~ 70°C
Working Humidity	10 ~ 80%

Warranty

UNIDEN DASH VIEW 40R

IMPORTANT: Satisfactory evidence of the original purchase is required for warranty service

Please refer to our Uniden website for any details or warranty durations offered in addition to those contained below.

Warrantor: The warrantor is Uniden Australia Pty Limited ABN 58 001 865 498 ("Uniden Aust").

Terms of Warranty: Uniden Aust warrants to the original retail purchaser only that the DASH VIEW 40R ("the Product"), will be free from defects in materials and craftsmanship for the duration of the warranty period, subject to the limitations and exclusions set out below.

Warranty period: This warranty to the original retail purchaser is only valid in the original country of purchase for a Product first purchased either in Australia or New Zealand and will expire one (1) year from the date of the original retail sale.

If a warranty claim is made, this warranty will not apply if the Product is found by Uniden to be:

- (A) Damaged or not maintained in a reasonable manner or as recommended in the relevant Uniden Owner's Manual;
- (B) Modified, altered or used as part of any conversion kits, subassemblies or any configurations not sold by Uniden Aust;
- (C) Improperly installed contrary to instructions contained in the relevant Owner's Manual
- (D) Repaired by someone other than an authorized Uniden Repair Agent in relation to a defect or malfunction covered by this warranty; or
- (E) Used in conjunction with any equipment, parts or a system not manufactured by Uniden.

Parts Covered: This warranty covers the Product and included accessories.

User-generated Data: This warranty does not cover any claimed loss of or damage to user-generated data (including but without limitation phone numbers, addresses and images) that may be stored on your Product.

Statement of Remedy: If the Product is found not to conform to this warranty as stated above, the Warrantor, at its discretion, will either repair the defect or replace the Product without any charge for parts or service. This warranty does not include any reimbursement or payment of any consequential damages claimed to arise from a Product's failure to comply with the warranty.

Our goods come with guarantees that cannot be excluded under the Australian Consumer Law. You are entitled to a replacement or refund for a major failure and for compensation for any other reasonably foreseeable loss or damage. You are also entitled to have the goods repaired or replaced if the goods fail to be of acceptable quality and the failure does not amount to a major failure.

This warranty is in addition to and sits alongside your rights under either the COMPETITION AND CONSUMER ACT 2010 (Australia) or the CONSUMER GUARANTEES ACT (New Zealand) as the case may be, none of which can be excluded.

Procedure for obtaining warranty service: Depending on the country in which the Product was first purchased, if you believe that your Product does not conform with this warranty, you should deliver the Product, together with satisfactory evidence of your original purchase (such as a legible copy of the sales docket) to Uniden. Please refer to the Uniden website for address details. You should contact Uniden regarding any compensation that may be payable for your expenses incurred in making a warranty claim. Prior to delivery, we recommend that you make a backup copy of any phone numbers, images or other data stored on your Product, in case it is lost or damaged during warranty service.

UNIDEN AUSTRALIA PTY LTD

Phone: 1300 366 895

Email: custservice@uniden.com.au

Uniden[®]

© 2024 Uniden Australia Pty Limited.
Printed in China v1.5