

Uniden®

BW30xx Series **2.3" LCD Portable Wireless** **Baby Monitoring System**

For more exciting new products please visit our website:

Australia: www.uniden.com.au

New Zealand: www.uniden.co.nz

OWNER'S MANUAL

IMPORTANT SAFETY INSTRUCTIONS

This manual contains important information about this product's operation. If you are installing this product for others, you must leave this manual or a copy with the end user.

When using your equipment, always follow basic safety precautions to reduce the risk of fire, electric shock and injury to persons, including the following:

- **This equipment is NOT waterproof.** DO NOT expose it to rain or moisture
- DO NOT immerse any part of the product in water. Do not use this product near water, e.g., near a bathtub, wash bowl, kitchen sink or laundry tub, in a wet basement or near a swimming pool.
- To avoid any risk of electric shock from lightning, avoid handling any electronic devices (except battery powered ones) during an electrical storm.
- Use only the power cord and/or batteries indicated in this manual. Never dispose of any batteries in a fire: they may explode. Check with local codes for possible special disposal instructions.
- Never tug or pull on any power cord: be sure to leave some slack in the cord when placing your equipment, and always use the plug to unplug cord from the wall outlet.
- Never leave power cords where they can become crushed, cut, or frayed; when running power cords, avoid letting them rub against any sharp edges or lie across any high traffic areas where people might trip over them.
- Do not use the device if the adaptor cords or plugs have been damaged, the unit has been exposed to liquids, or the unit has been dropped or is damaged.

Warning to Parents and Other Users

Failure to follow these warnings and the assembly instructions could result in serious injury or death. This product is not designed or intended for use as a medical monitor, nor should this product be used as a substitution for medical or parental supervision. Always be sure that both the transmitter and receiver are working properly, and are within range of each other.

STRANGULATION HAZARD. Keep the adaptor cords out of the reach of children.

WARNING: KEEP OUT OF THE REACH OF CHILDREN.

Allow for proper ventilation when units are in use. Do not cover the camera or receiver with any object such as a blanket. Do not place it in a drawer or in any location which would muffle the sound or interfere with the normal flow of air.

SAVE THESE INSTRUCTIONS!

For best results

To avoid damage to your equipment, follow these simple precautions:

- Do not drop, puncture or disassemble any part of the equipment. There are no user-serviceable parts inside.
- Do not expose the equipment to high temperatures, and avoid leaving the equipment in direct sunlight for more than a few minutes. Heat can damage the case or electrical parts.
- Do not place heavy items on top of the equipment or expose the equipment to heavy pressure.
- Remove the power adaptor during long periods between usages.
- Clean only with a dry cloth.

Failure to follow the instructions in this operating manual will void the warranty. Uniden assumes no liability for damages to property or injury to persons caused by improper handling or failure to comply with these safety instructions.

CONTENTS

WHAT'S IN THE BOX?	5
INSTALLATION	6
Monitor	6
Camera	6
BASIC OPERATION	8
Wireless Camera	8
Wireless Monitor	10
LCD Display	12
USING THE BW30XX SERIES	14
SYSTEM MENU DESCRIPTIONS	15
System	16
Alert	20
VOX	21
Power Save	21
Camera	22
SPECIAL FEATURES	24
Zoom	24
Night Light	24
Lullabies	24
Using The Intercom	25
Camera Pairing	25
Maintaining Your System	25
SOLVING PROBLEMS	26
SPECIFICATION	27
General	27
Camera	27
Monitor	28
ONE-YEAR LIMITED WARRANTY	29

WHAT'S IN THE BOX?

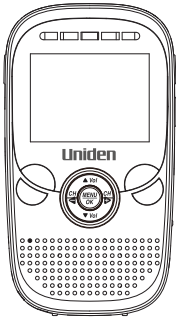

Digital Wireless Monitor*

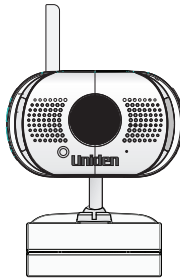

Digital Wireless Camera*

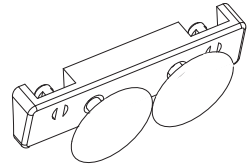

Suction Cup Adaptor Bar



AC Power Adaptor*



Screws and Anchors

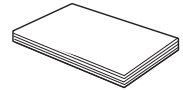

Owner's Manual

* Refer to the table below.

Model Name	2.3" Monitor	Indoor Camera	Adaptors
BW3001	1	1	1 x Camera Power Adaptors 1 x Monitor Power Adaptors
BW3002	1	2	2 x Camera Power Adaptors 1 x Monitor Power Adaptors

- If any item is missing or damaged, contact your place of purchase immediately.
Never use damaged products!
- Need help? Get answers at our website:
www.uniden.com.au for Australian model
www.uniden.co.nz for New Zealand model.

INSTALLATION

MONITOR

1. Place the monitor in a location with clear reception from your camera(s). Place it a minimum of 1m from the crib.
2. Plug the AC adaptor power plug into the monitor's DC adaptor input jack.
3. Plug the power plug into a 240 volt AC (standard indoor) power outlet or surge protector.
4. Press and hold **POWER** to turn the unit on or off. Let the monitor charge for 6 hours prior to first time use so the built-in rechargeable monitor battery is fully charged. **DO NOT** remove the power cable from the monitor during the initial charge process. After the initial charge, recharge the monitor as needed.
5. *Out of range* displays on the LCD until you turn on the camera.

CAMERA

The BW3000 camera and mounting clip are a complete unit. The BW3000 Camera does come with a separate suction cup bar. With it installed, you can mount the camera on glass or smooth metallic surfaces.

Placement Considerations

- The camera included with your monitor is **NOT** weatherproof; it is an indoor camera.
 - The clearest line-of-sight between the camera and monitor is best. Walls, especially brick and concrete, can affect reception quality.
 - Avoid having a direct light source in view of the camera (ceiling or floor lamps).
 - Carefully plan where and how the camera will be positioned, and where you will route the cable that connects the camera to the power adaptor. Place it a minimum of 3 feet from the crib.
 - When you are positioning the camera, bring the monitor along; it's much easier to get the camera into the right position when you have the display handy. Check the image on the monitor before you install the camera.
 - *Out of range* displays when the camera is out of range, turned off, or unsuccessfully paired to the monitor. It also displays when the monitor is out of range.
- ✗ **You can install additional cameras (maximum of 4 cameras). When adding cameras that were not included in the original box, you will need to pair the cameras with the monitor. Refer to page 25.**

Wall Mount

The Indoor Camera mounting clip has two slots that fit over screws to mount the unit on the wall.

1. Mark the position of the screw holes on the wall.
2. Drill holes and insert the anchors and screws provided.
3. Be sure to leave room for the mounting to fit over the screw heads.
4. Place the mounting over the installed screws and push it downwards, locking it into place.
5. Adjust the camera as needed.

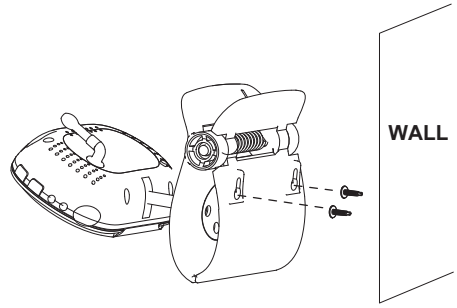

Suction Mount

1. Insert the suction base into the mounting clip as shown.
 2. Firmly press the camera with the suction base attached onto glass or metallic surfaces.
 3. Adjust the camera as needed.
- ✗ **“Suctions will not stick well on a curved/ textured or wet surface. Make sure the spot is smooth and flat. Dry the spot completely (use a lint-free cloth, if possible).**

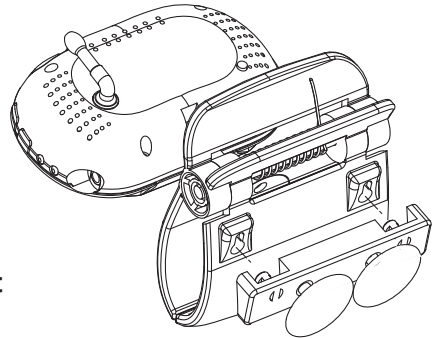

Clip Mount

Clip the Indoor Camera on ledges and shelves.

1. Press the mounting clip as shown.
2. Place the unit over the mounting surface and release.
3. Adjust the camera as needed.

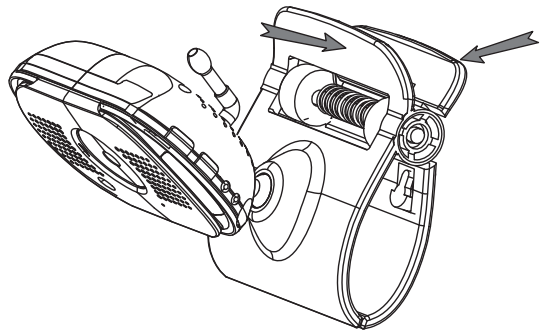

Connect Power

1. Insert the AC adaptor power plug into the camera's DC adaptor input jack.
2. Plug the other end into a 240 volt AC (standard indoor) power outlet or surge protector. The charging LED turns on. If the battery is not fully charged, the LED glows red. If it is fully charged, the LED glows green.
3. Press **POWER**. The green power LED turns on and the monitor now displays camera video. If it doesn't, try reconnecting the AC adaptor, making sure the power outlet isn't controlled by a wall switch.

BASIC OPERATION

WIRELESS CAMERA

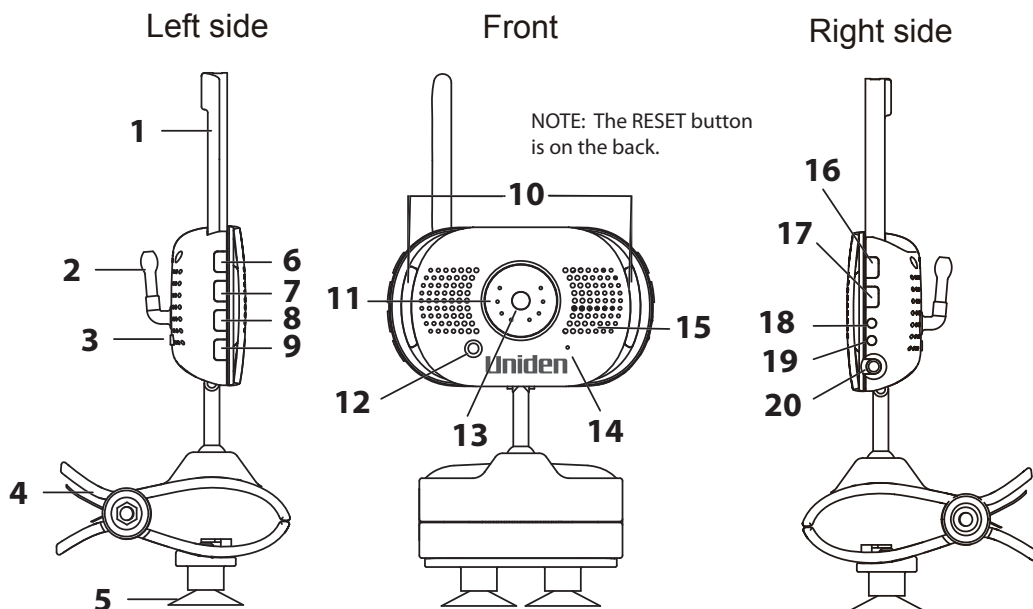

No	Keys/Indicators	Function
1	Camera Antenna	Sends and receives signals to and from the monitor
2	Temperature sensor	Detects temperature at camera side and displays it on the monitor LCD
3	Pair	Pairs the camera to the monitor.
4	Mounting Clip	This fastener can attach the camera to shelves or ledges.
5	Suction Base	Attach to mount the camera on glass or metallic surfaces.
6	▲Vol	Increase speaker volume.
7	▼Vol	Decrease speaker volume.
8	Lullaby PLAY/ STOP	Press this button to play lullabies. See page 24 for details.
9	Lullaby SKIP	Press to play next lullaby. See page 24 for details.
10	LED night light bars	
11	IR LEDs (Covered)	Infrared LEDs provide viewing in no/low light conditions.

12	Light Sensor	Measures light intensity on the camera side.
13	Camera Lens	
14	Microphone	Receives sounds for the area near the camera, and transmits sound from the camera to the monitor.
15	Speaker	Produces the sound transmitted from the monitor.
16	POWER	Turns the camera ON or OFF.
17	NIGHT LIGHT	Press to turn the night light ON or OFF.
18	Charging LED	Red = Charging Green = Fully charged Off = Camera and power adaptor are disconnected or power adaptor is disconnected from power source.
19	Power LED	Green = Camera is turned on. Green (Blinking) = Battery is low.
20	DC 5V Power	Connects the DC 5V power adaptor to the camera.

WIRELESS MONITOR

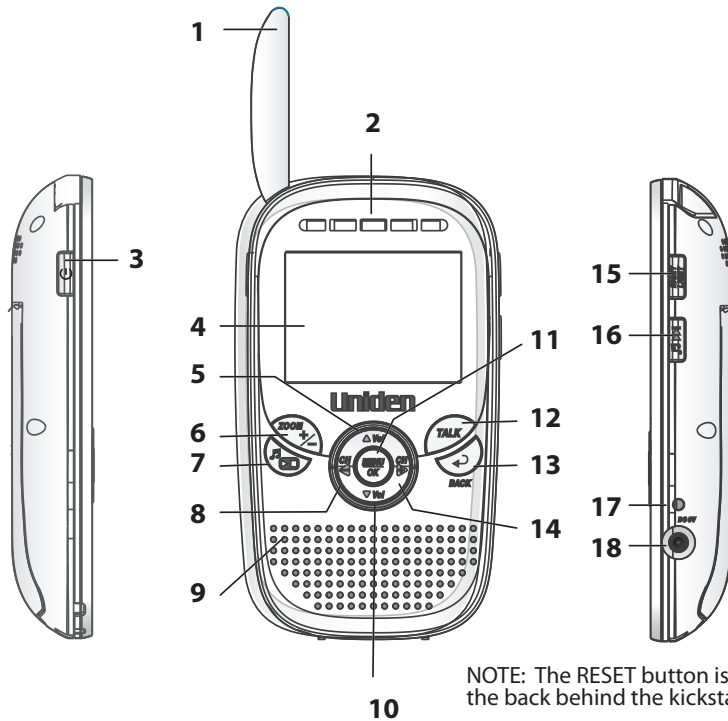

NOTE: The RESET button is on the back behind the kickstand.





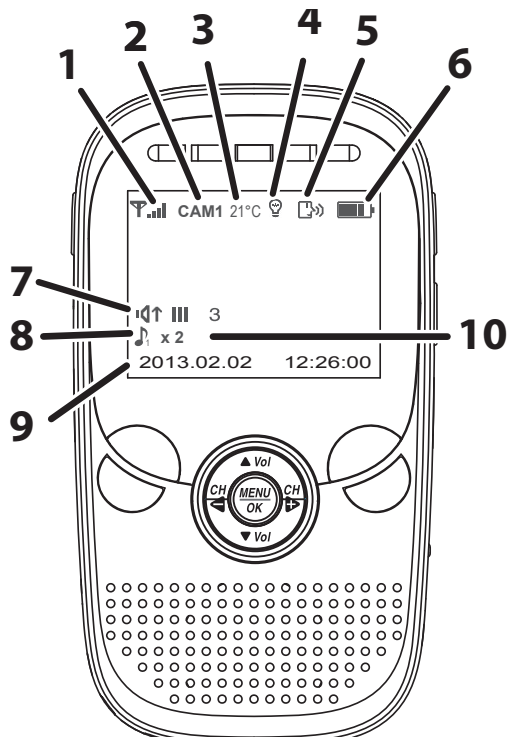

No	Keys/Indicators	Function
1	Monitor Antenna	Sends and receives signals to and from the monitor.
2	LED light bar	The left LED indicates power and remaining LEDs indicate sound.
3	POWER	Turns the camera on and off.
4	2.3 inch LCD screen	
5	▲Vol	<ul style="list-style-type: none"> • Increase speaker volume. • In Menus: Scroll up. • In Lullaby: increase volume. • In Zoom: Scroll up.
6	ZOOM	Displays the camera image in double size (see page 24).
7	LULLABY PLAY/STOP	Press this button to remotely play lullabies. See page 24 for details.
8	CH◀	<ul style="list-style-type: none"> • In Menu: Scroll left. • In Zoom: Scroll left. • In Live view: Switch between available cameras.

9	Microphone	
10	▼Vol	<ul style="list-style-type: none"> • Decrease speaker volume. • In Menus: Scroll down. • In Lullaby: decrease volume. • In Zoom: Scroll down.
11	MENU/OK	Select a menu option or accept a setting.
12	TALK	Activate Intercom function (see page 25).
13	BACK	In Menus: Back one level.
14	CH▶	<ul style="list-style-type: none"> • In Menus: Scroll right. • In Zoom: Scroll right. • In Live view: Switch between available cameras.
15	NIGHT LIGHT:	Remotely turn the camera night light ON or OFF .  The monitor's night light function is only available when the camera is paired to the monitor.
16	LULLABY SKIP:	Skips to the next lullaby in the series. See page 24 for details.
17	Charge LED	RED = Charging Green = Charging complete If the monitor becomes unplugged from the adaptor, this LED turns off.
18	DC 5V Power:	Connects the DC 5V power adaptor to the monitor.

LCD Display



No	Icon	What it indicates																		
1		<p>Signal Indicator (displays in full screen mode only). The number of bars in the signal indicator shows the strength of the signal received from the camera. One or no bars indicates the signal is poor, and 4 bars indicate a very strong signal.</p> <table border="1"> <thead> <tr> <th>Signal Strength</th> <th>Indicator</th> <th>Warning</th> </tr> </thead> <tbody> <tr> <td>Strong</td> <td></td> <td>None</td> </tr> <tr> <td>Good</td> <td></td> <td>None</td> </tr> <tr> <td>Fair</td> <td></td> <td>None</td> </tr> <tr> <td>Low</td> <td></td> <td>None</td> </tr> <tr> <td>No Signal</td> <td></td> <td>Out of Range</td> </tr> </tbody> </table>	Signal Strength	Indicator	Warning	Strong		None	Good		None	Fair		None	Low		None	No Signal		Out of Range
Signal Strength	Indicator	Warning																		
Strong		None																		
Good		None																		
Fair		None																		
Low		None																		
No Signal		Out of Range																		

2	CAM1	<p>Camera Indicator. indicates which camera is displaying. Press CH▶ or CH◀ on the monitor to switch between available cameras. It will cycle in the following order:</p> <p>CH▶ : CAM1—CAM2—CAM3—CAM4—QUAD—AUTO SCAN — CAM1</p> <p>CH◀ : CAM1—Auto SCAN—QUAD—CAM4—CAM3—CAM2—CAM1</p>
3	21°C	Temperature indicator (displays in full screen mode only). Displays the temperature on the camera side.
4		Night light indicator (displays in full screen mode only). Displays when the night light is turned on. (See page 24)
5		<ul style="list-style-type: none"> Intercom (Talk). Displays in full screen mode only when you press and hold TALK on the monitor (see page 25).
6		Battery level. Indicates the amount of power left in the battery. The  icon displays when the battery is charging.
7		Volume indicator. Displays when ▲Vol or ▼Vol is pressed on the monitor. If the volume is muted,  displays.
8		Lullaby. Displays in full screen mode only when a lullaby is playing. The number indicates which melody is playing (see page 24).
9	2013.02.02 12:26:00	<p>Date and Time (displays in full screen mode only). Displays the time as set through the monitor.</p> <p>Date: 2013.02.02 - year.month.day</p> <p>Time: 12:26:00 - hour:minute:second</p>
10	x 2	ZOOM indicator. If you press ZOOM, X2 displays after the Lullaby indicator (item 8). The zoomed image displays as the background image.

USING THE BW30XX SERIES

Viewing Modes

Live view displays live images from the cameras in the following modes:

- Quad mode: Monitor displays video from all cameras on a single screen in 4 quadrants. Any channel that does not have a camera remains blank.
- Single mode: Monitor displays video from one camera at a time.
- Scan mode: Monitor displays video from one camera at a time, but cycles through all cameras one by one.

Use CH▶ or CH◀ to cycle through these modes.

✗ **Your system comes with a single camera; therefore, it only displays in Single mode in Live view or a single quadrant in Quad view.**

Common Operations

To...	Do...
Change between quad view, single view, and scan for Live view	Press CH▶ to cycle through the Live modes in the following order: CAM1—CAM2—CAM3—CAM4—QUAD—AUTO Scan — CAM1
Check the temperature	The temperature displays on the monitor screen when the camera is in full screen mode. See page 19.
Turn on the night light	Press NIGHT LIGHT on the side of the camera (page 24) or on the monitor (page 24). See page 24 for details.
Set the date and time	See page 16.
Set the room temperature range for the temperature alert	See page 19.
Use the Lullaby function	See page 24.
Adjust BW30xx Series volume	Press ▲Vol (increase volume) or ▼Vol (decrease volume) on either the camera or the monitor.
Use the Intercom	<ol style="list-style-type: none">1. Press and hold TALK on the monitor.2. Speak into the microphone.3. Release to hear reply.

SYSTEM MENU DESCRIPTIONS

Press **MENU/OK** to access system menus. Use the navigating buttons to navigate up (▲Vol), down (▼Vol), left (CH◀), and right (CH▶) in the menus, then press **MENU /OK** to confirm a setting.

Use CH▶ or CH◀ to focus on the 5 different system menu selections on the clothesline.

- System
- Power Save
- Camera
- VOX
- Alert



SYSTEM

Move the focus to the System option and press **MENU/OK** to access the six System options:

- Date/Time
- Brightness
- Factory Reset
- Language
- Temp. display unit
- Temp. alert range

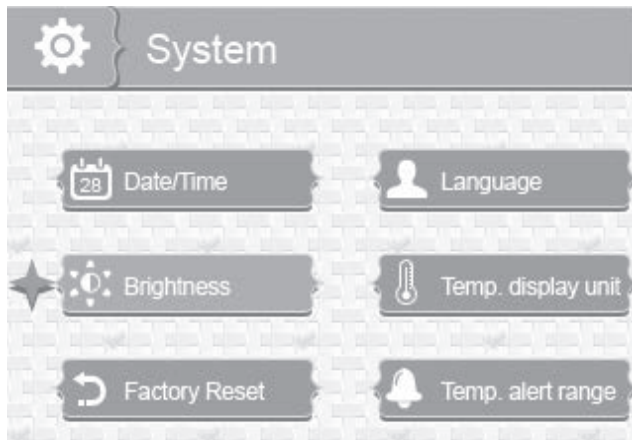

Date & Time

This option allows you to set the system date and time.

The display format is Year.Month.Day. Hour:Minute

1. From the System menu, select Date/Time and press **MENU/OK**. The *Date/Time* screen displays.

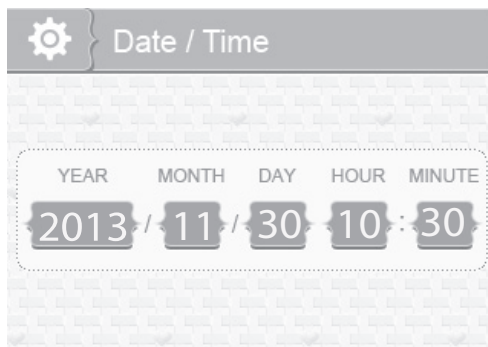

2. Press **▲Vol** or **▼Vol** to increase/decrease the number for that setting.
3. Press **CH▶** or **CH◀** to save the current setting and move to the next setting.
4. Press **MENU/OK** to save the completed date and time setting and return to the main System options. Press the **BACK** button to step backwards one level until you are out of the menu system.

Brightness

This option allows you to adjust the brightness level for each camera. (Default = 3)

1. From the System menu, select Brightness and press **MENU/OK**. The *Brightness* screen displays.

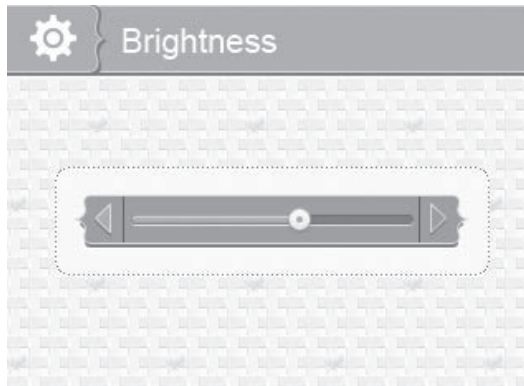

2. Press CH▶ or CH◀ to increase or decrease the brightness level (6 levels).
3. Press **MENU/OK** to save the setting and return to the main System options. The new brightness level displays in the Live view.

Factory Reset

This option allows you to restore your system to factory settings. (Default = No)

1. From the System menu, select Factory Reset and press **MENU/OK**. The *Factory Reset* screen displays.



2. Press ▲Vol or ▼Vol to select or cancel a reset to factory defaults.
3. Press **MENU/OK** to save the setting and return to the main System options.

✗ **Camera pairing and Date/Time setting will NOT be affected by a reset. Cameras will remain paired with the monitor.**

Language

This option allows you to select the system's display language from English, Español, or Français. (Default = English)

1. From the System menu, select Language and press **MENU/OK**. The *Language* screen displays.



2. Press **▲Vol** or **▼Vol** to select a language.
3. Press **MENU/OK** to save the setting and return to the main System options.

Temperature Display Unit

This option allows you to set the temperature to display in Celsius (C) or Fahrenheit (F). (Default = C)

1. From the System menu, select Temp. display unit and press **MENU/OK**. The Temp. display unit screen displays.

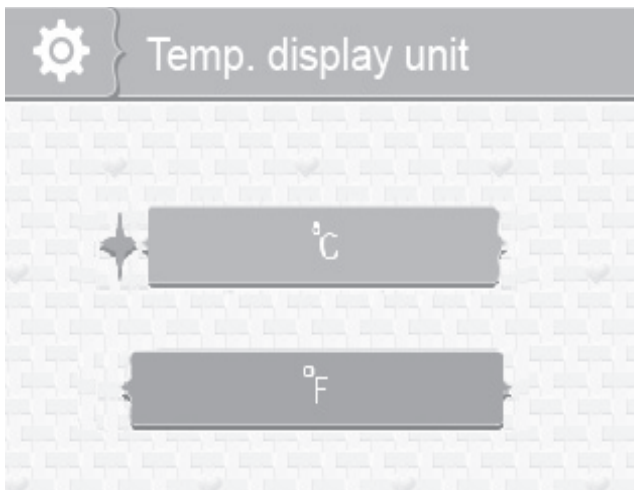

2. Press **▲Vol** or **▼Vol** to select °C or °F.
3. Press **MENU/OK** to save the setting and return to the main System options.

Temperature Alert Range

BW30xx Series measures the ambient room temperature where the camera is. If the temperature falls outside of a preset range, the system alerts you (the temperature indicated on the display screen turns red and starts to flash).

Temp. alert range lets you set that range.

[Default = Low Temperature: 16°C ; High Temperature; 25°C; Off]

1. From the System menu, select Temp. alert range and press **MENU/OK**. The *Temp. alert range* screen displays.

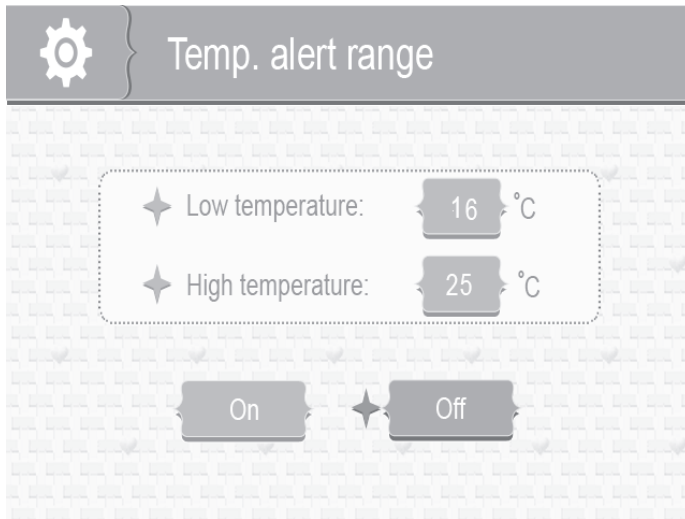

2. Press CH▶ or CH◀ to select Low temperature or High temperature.
3. Press ▲Vol or ▼Vol to increase or decrease the temperature value.
4. After setting the temperature range, press CH▶ or CH◀ to select the On/Off row.
5. Press CH▶ or CH◀ to toggle between On (Enable) or Off (disable). Either button will work.
6. Press **MENU/OK** to save the settings and return to the main System options.

ALERT

Temperatures out of range or a camera out of range triggers alerts. This option allows you to set the alert volume. There are 6 levels available.

[Default = Zero (Mute)]



1. From the main menu selections, select Alert and press **MENU/OK**. The *Alert* screen displays.



2. Press CH▶ or CH◀ to adjust the volume.
3. Press **MENU/OK** to save the selection and return to the main menu selections.

VOX

This option allows you to set the sound sensitivity for the camera. (Default = High)

1. From the main menu selections, select **VOX** and press **MENU/OK**. The **VOX** sensitivity screen displays.



2. Press **▲Vol** or **▼Vol** to select a level (High, Low, or Off).
3. Press **MENU/OK** to save the selection and return to the main menu selections.

POWER SAVE

Activating the Power Save feature turns off the LCD after two minutes of inactivity. This option allows you to enable or disable this function. (Default = Off)

Voice Activation (VOX) will turn the LCD back on. Be sure that VOX is activated, (see above). If VOX is deactivated, press any button on the monitor to turn the LCD back on. Even with the LCD off, the LED light bar is still active

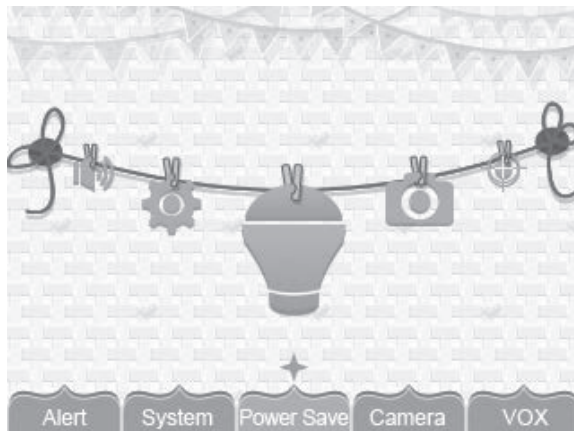

1. From the main menu selections, select **Power Save** and press **MENU/OK**. The **Power Save** screen displays.

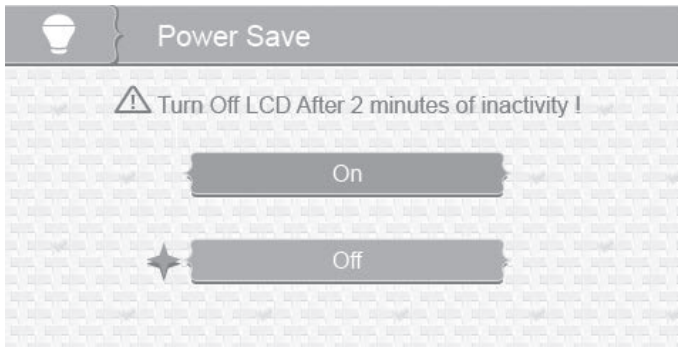

2. Press ▲Vol or ▼Vol to toggle between turning the Power Save feature on or off.
3. Press **MENU/OK** to accept that setting and return to the main menu selections.

CAMERA

This option allows you to pair the monitor with cameras (up to 4 cameras supported) or to turn on/off an individual camera. The cameras are still powered on but no longer visible to the monitor.



1. From the main menu selections, select Camera and press **MENU/OK**.
2. The *Camera* screen displays. Two options display: Pair and On/Off.

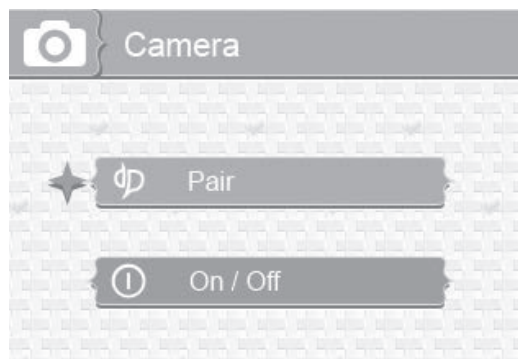

Pair

Pairing allows you to introduce additional cameras to the monitor. The monitor can then recognize and display video from them. The camera that comes with this system is already paired.

- ✗ **Before pairing additional cameras, be sure they are powered and turned on.**
See page 6.

1. Select Pair from the Camera screen. The camera selection screen displays.

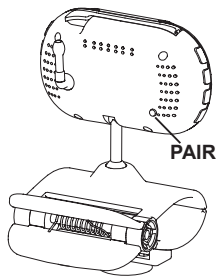

2. Press ▲Vol or ▼Vol to select the camera you want to pair, then press **MENU/OK**. The monitor prompts you to press **PAIR** on the back of the camera within 30 seconds.
3. Press **PAIR** on the back of the camera within 30 seconds.
4. That camera's video displays on the monitor when pairing is successful.

- ✗ **Pair the cameras to the monitor before mounting them.**

On/Off

This option allows you to turn individual cameras on/off so their video is not visible through the monitor. (Default = Camera 1 - On; Cameras 2 - 4 - Off)

1. Select On / Off from the Camera options screen. The On / Off screen displays.

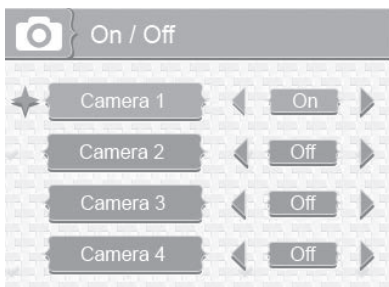

2. Press ▲Vol or ▼Vol to select a camera.
3. Press CH▶ or CH◀ to toggle between On and Off for that camera. Either button will work.
4. Press ▲Vol or ▼Vol to select another camera.
5. Press **MENU/OK** to accept that setting and return to the Camera options screen.

SPECIAL FEATURES

ZOOM

ZOOM displays the camera image in double size. Press ▲Vol, ▼Vol, CH▶, or CH◀ to see the parts of the image not displayed on the LCD screen. Press ZOOM again to return to normal view.

NIGHT LIGHT

You can control the BW30xx Series night light using the **NIGHT LIGHT** button on the right side of either the monitor or the camera. However, if you want to control it from the monitor, you must place that camera in full screen mode.

1. To turn the night light on from the monitor, place the night light camera in full screen mode.
2. Press **NIGHT LIGHT** on the side of the monitor or the camera. The camera's night light turns on and a night light icon displays on the monitor.
3. Press **NIGHT LIGHT** again to turn it off.

LULLABIES

Your system comes with four preprogrammed lullabies. You can control the lullabies from either the monitor or the camera. However, if you want to control them from the monitor, the camera you want to play them through must be in full screen mode.

When you press **LULLABY PLAY/STOP** to turn on the lullaby feature, Lullaby #1 begins playing. It will repeat until you press **LULLABY SKIP** to move to the next lullaby.

The Lullaby feature can also play all lullabies one after the other. Press **LULLABY PLAY/STOP** to turn on the Lullaby system and begin playing Lullaby #1. Lullaby #1 repeats until you press a Lullaby button.

Press **LULLABY SKIP** four (4) times after Lullaby #1 begins playing. Lullaby #1 restarts and then cycles through the rest of the lullabies.

1. To control the lullabies from the monitor, decide which camera you want to play lullabies and ensure that particular camera is displayed full screen live view camera.
2. Press **LULLABY PLAY/STOP** on the monitor or camera. The system plays Lullaby #1 then repeats it.
3. Press **LULLABY SKIP** to skip to Lullaby #2. The system plays Lullaby #2 then repeats it.
4. Press **LULLABY SKIP** to skip to Lullaby #3. The system plays Lullaby #3 then repeats it.

5. Press **LULLABY SKIP** to skip to Lullaby #4. The system plays Lullaby #4 then repeats it.
6. Press **LULLABY SKIP** to skip to Lullaby #1. The system plays Lullaby #1 then cycles through all lullabies.

Press ▲Vol and ▼Vol on the monitor or camera to adjust the volume. Press ▼Vol all the way down on the monitor to mute the lullaby playing through the monitor.

USING THE INTERCOM

The Intercom feature lets you talk to whomever is within camera range.

1. Decide which camera you want to establish an intercom link with, and make it the full screen live view camera.
2. Press and hold **TALK** the monitor.
3. Speak clearly into the microphone.
4. Release **TALK** to listen to the response.

CAMERA PAIRING

The system comes with one camera that has already been paired. It will communicate with the monitor when it is powered on.

The pairing function lets you add up to 3 additional cameras to your system. It also lets you re-pair your first camera if needed.

✎ **Pair the cameras to the monitor before mounting the cameras.**

1. Verify that the monitor is powered on (see page 6).
2. Install and power on the accessory cameras according to the procedures beginning on page 6.
3. Pair the accessory cameras according to the procedures on page 23.
4. Once the camera has been paired, it will be immediately viewable on the monitor.

MAINTAINING YOUR SYSTEM

MONITOR

As you use your monitor, keep the screen clean by wiping it with a microfiber cloth to remove fingerprints, dust, etc.

CAMERA

When dust and grime builds up on the camera lens and glass, it affects the camera's "vision." Use a microfiber cloth to regularly clean the camera(s) or when night vision video is cloudy or unclear.

SOLVING PROBLEMS

If...	Try...
There is no picture from the camera	<ul style="list-style-type: none"> • checking all connections to the camera. Make sure the adaptor is plugged in. • making sure that the cameras and monitor are both ON. • making sure that the camera is in range of the monitor.
The picture is dropping	<ul style="list-style-type: none"> • moving the camera closer to the monitor. • repositioning the camera, monitor or both to improve the reception. • adjusting the monitor and camera antennas to vertical position.
There are audio problems	<ul style="list-style-type: none"> • making sure that there is sound within range of the camera microphone. • moving the camera or monitor farther apart if the unit emits a loud screeching noise (feedback).
The picture has become choppy	<p>The picture may become choppy when experiencing a lower frame rate. Try:</p> <ul style="list-style-type: none"> • moving the camera closer to the monitor. • removing obstructions between the monitor and camera. • adjusting the monitor and camera antennas to vertical position.
The monitor picture has frozen	<p>Use a blunt object like an unbent paper clip to press RESET and reset the monitor. The monitor turns off. Press POWER to turn it back on again.</p>
There is an irregular beeping coming from the monitor	<p>That is the Alert tone. Go to the Alert screen to turn the alert volume down or off (see page 20).</p>

SPECIFICATION

GENERAL

	Camera	Monitor
Operating Frequency Range	2.400 ~ 2.4835GHz	
TX Power	15dBm	NA
RX Sensitivity	NA	-81dBm
Type of Spread Spectrum Used	FHSS	
Type of Modulation Used	GFSK	
Communication Range	150ms Line of Sight	

CAMERA

Image Sensor Type

Manufacturer/ Model # 1/6.5" Color CMOS Image sensor

Effective Pixel	• 640 x 480
Image Processing	• MJPEG
Lens	• 3.0mm / F2.8
Exposure	• Auto
White Balance	Auto
Power Requirement	5.0VDC +/-5%
Power Consumption	150mA Max (IR OFF) 730mA Max (IR ON) 440mA Max (Charging)
Operating Temperature Range	-10°C ~ 40°C (14°F ~ 104°F)
Operating Humidity Range	Within 80% Relative Humidity
RoHS Compliance	Yes
Housing Material	Plastic

MONITOR

Display Size/Type	2.3" TFT LCD
Resolution	320 x 240
Power Requirement	5.0VDC +/-5%
Power Consumption	<ul style="list-style-type: none">• 260mA Max (Normal)• 740mA Max (Charging)
Operating Temperature Range	-10°C ~ 40°C (14°F ~ 104°F)
Operating Humidity Range	Within 85% Relative Humidity
RoHS Compliance	Yes
Battery Life	4.5 hours
Housing Material	Plastic

ONE-YEAR LIMITED WARRANTY

BW30xx Series

IMPORTANT Satisfactory evidence of the original purchase is required for warranty service. Please refer to our Uniden website for any details or warranty durations offered in addition to those contained below.

Warrantor

The warrantor is either Uniden Australia Pty Limited ABN 58 001 865 498 (“Uniden Aust”) or Uniden New Zealand Limited (“Uniden NZ”) as the case may be.

Terms of Warranty

Uniden Aust/NZ warrants to the original retail purchaser only that the BW30xx Series (“the Product”), will be free from defects in materials and craftsmanship for the duration of the warranty period, subject to the limitations and exclusions set out below.

Warranty Period

This warranty to the original retail purchaser is only valid in the original country of purchase for a Product first purchased either in Australia or New Zealand and will expire one (1) year from the date of the original retail sale.

If a warranty claim is made, this warranty will not apply if the Product is found by Uniden to be:

- (A) Damaged or not maintained in a reasonable manner or as recommended in the relevant Uniden Owner’s Manual;
- (B) Modified, altered or used as part of any conversion kits, subassemblies or any configurations not sold by Uniden Aust or Uniden NZ;
- (C) Improperly installed contrary to instructions contained in the relevant Owner’s Manual
- (D) Repaired by someone other than an authorized Uniden Repair Agent in relation to a defect or malfunction covered by this warranty; or
- (E) Used in conjunction with any equipment, parts or a system not manufactured by Uniden.

Parts Covered

This warranty covers the Product and included accessories.

User-generated Data

This warranty does not cover any claimed loss of or damage to user-generated data (including but without limitation phone numbers, addresses and images) that may be stored on your Product.

Statement of Remedy

If the Product is found not to conform to this warranty as stated above, the Warrantor, at its discretion, will either repair the defect or replace the Product without any charge for parts or service. This warranty does not include any reimbursement or payment of any consequential damages claimed to arise from a Product's failure to comply with the warranty.

Our goods come with guarantees that cannot be excluded under the Australian Consumer Law. You are entitled to a replacement or refund for a major failure and for compensation for any other reasonably foreseeable loss or damage. You are also entitled to have the goods repaired or replaced if the goods fail to be of acceptable quality and the failure does not amount to a major failure.

This warranty is in addition to and sits alongside your rights under either the COMPETITION AND CONSUMER ACT 2010 (Australia) or the CONSUMER GUARANTEES ACT (New Zealand) as the case may be, none of which can be excluded.

Procedure for Obtaining Warranty Service

Depending on the country in which the Product was first purchased, if you believe that your Product does not conform with this warranty, you should deliver the Product, together with satisfactory evidence of your original purchase (such as a legible copy of the sales docket) to Uniden at the addresses shown below. You should contact Uniden regarding any compensation that may be payable for your expenses incurred in making a warranty claim. Prior to delivery, we recommend that you make a backup copy of any phone numbers, images or other data stored on your Product, in case it is lost or damaged during warranty service.

UNIDEN AUSTRALIA PTY LTD

Service Division
345 Princes Highway,
Rockdale, NSW 2216
Phone number: 1300 366 895
Email address: custservice@uniden.com.au

UNIDEN NEW ZEALAND LTD

Service Division
150 Harris Road, East Tamaki
Auckland 2013
Phone number: (09) 273 8377
Email address: service@uniden.co.nz

Uniden®

©2013 Uniden Australia Pty Ltd/Uniden New Zealand Limited
Printed in PRC