

Uniden[®]

App Cam Solo X2K (1, -2, -4pcs)

Quick Start Guide

What's in the Box



Camera



Bracket



Power cable



Screws



Owner's Manual



Solar panel (3W)
(SPS-X Optional)

General Introduction

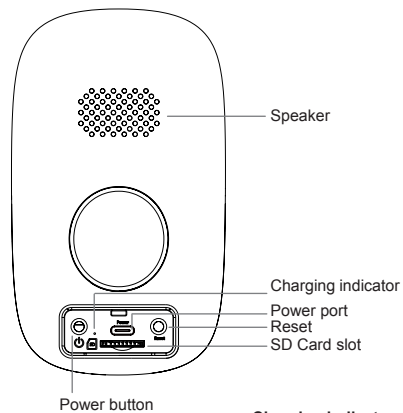
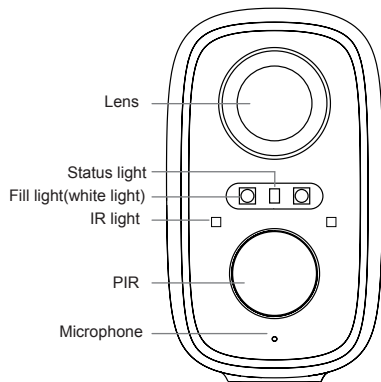

Charging indicator:

- Charging.
- Fully Charged.

General Introduction

Component	Description
Power Port	DC 5V/1A
Power ON/ OFF	Press and hold Power button for 3 seconds to Turn ON/ OFF camera
Status light	Red light flashes slowly: Camera start up and wait for connection. Red light flashes fast: Connecting the network. Solid Blue light: Camera is working correctly. Solid Red light: Camera is malfunction.
SD card slot	Support local SD Card storage (up to 256GB)
Reset	Press and hold for 5 seconds to reset the camera
Battery	5,200mAh rechargeable Li-h batteries.

Camera Installation



* Before installation, please check the installation positions that will not affect the connection and usage, especially to ensure that the solar panel can be fully illuminated.

Camera Installation

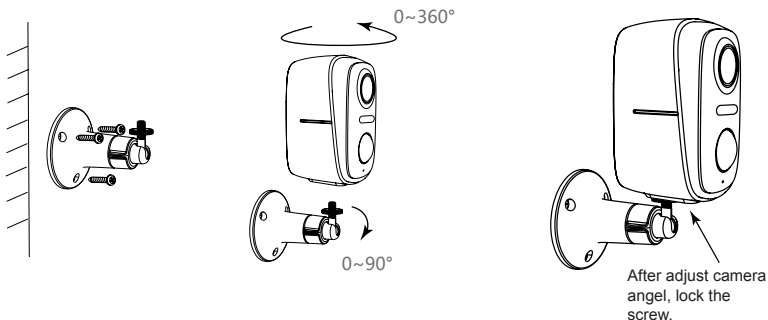

Solar Panel (3W) Installation (Optional)

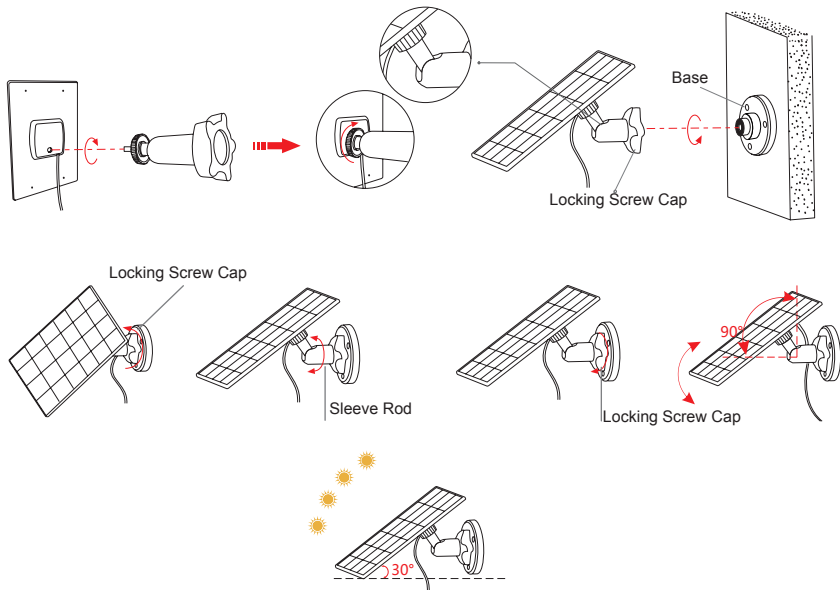

Solar Panel (3W) Installation (Optional)

Please select a position with the most sunlight throughout the year for your solar panel.

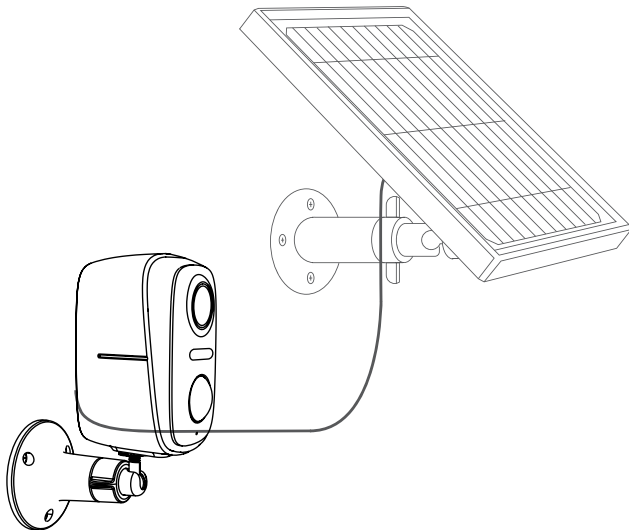

Install My Uniden + App



Download the My Uniden + App:

- Apple Store: “My Uniden+” (for iOS), download and install the app.
- Google Play Store: “My Uniden+” (for Android), download and install the app.



Support Alexa & Google Home

Set up the Camera

1. Register your account, tap “Sign up now” to create your account.
2. After you have the account, please log in.

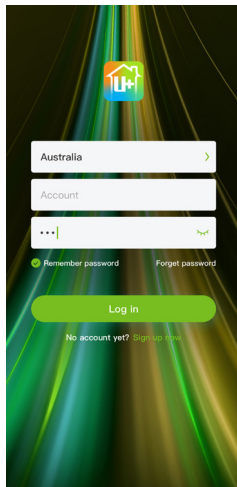

Add Camera to My Uniden + App

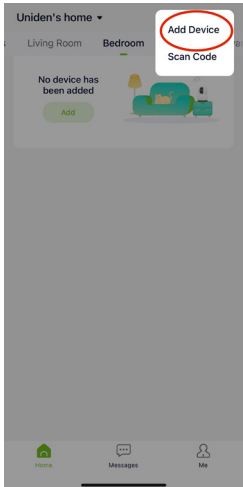

1

Tap “+” on the right top corner to add device.

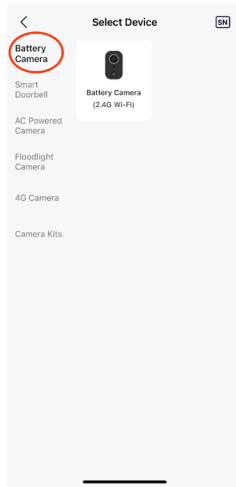

2

Tap “Battery Camera”, choose “Battery Camera”.

Please follow the prompt tone to configure the camera

Add Camera to My Uniden + App

Please follow the prompt tone to configure the camera

“ Please Insert SD Card. ”

“ Hold the device power button to start the device. ”

Red light flashes slowly: Camera start up and wait for connection.

More light settings, please refer to p3- **Status light.**

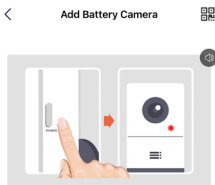

Hold the device power button to start the device.

- Press the [battery camera] button to wake up the device if it is asleep.
- Please stay near to your router for the best signal.

Next

3

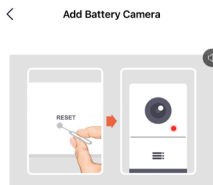

Please reset the device.

- Hold the RESET button on your device for 4-5 seconds(please refer to the user manual for more on this).
- Wait for a flashing RED indicator light.
- Tap Next

Next

4

Add Camera to My Uniden + App

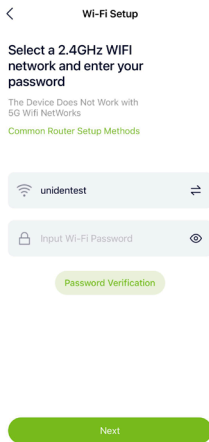

5

“Scan the QR code from the App. Keep your phone 15~25cm from the lens.”

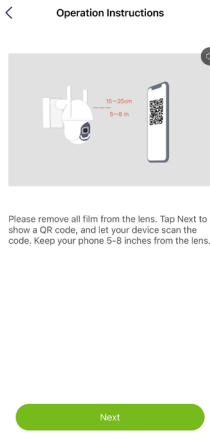

6

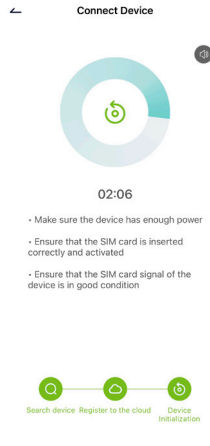

7

“Connection successful , waiting to add to app ”

Add Camera to My Uniden + App

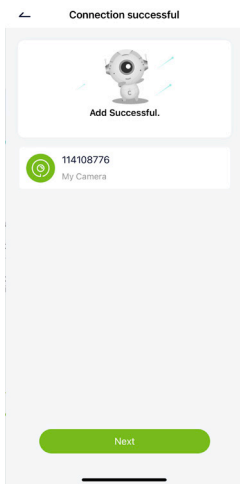

8

“Connection successful.

”

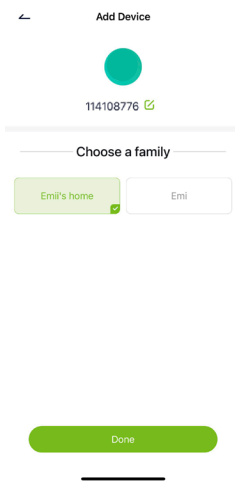

9

Click  to edit Camera name.

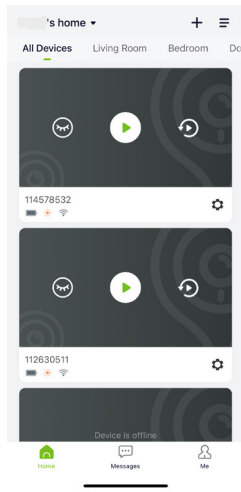

10

Camera Specification

• PIR Sensor Detecting Distance

The PIR detection range can be customized to meet your specific needs. You can refer to the following table to set it up in the My Uniden + App.

Sensitivity	Value	Detecting Distance (For moving and living things)	Detecting Distance (For moving vehicles)
Low	1-4	Up to 4 meters	Up to 4 meters
Mid	5-7	Up to 6 meters	Up to 6 meters
High	8-10	Up to 8 meters	Up to 8 meters

Note:

Higher sensitivity offers longer detecting distance, but it would lead to more false alarms. You are advised to set up the sensitivity level to “1-4” or “5-7” when you install the camera outdoors.

• PIR Sensor Installation Angle

Please install the camera 2-3 meters above the ground. The detection range of the motion sensor would be maximized at such a height.

For effective motion detection, please install the camera angularly and the angle between the PIR sensor and the detected object must be larger than 10° .

Due to the limitation of PIR sensor detection, please note that **if a moving object approaches the PIR sensor vertically (the direction of the orange arrow in the image)**, the camera may fail to detect motion.

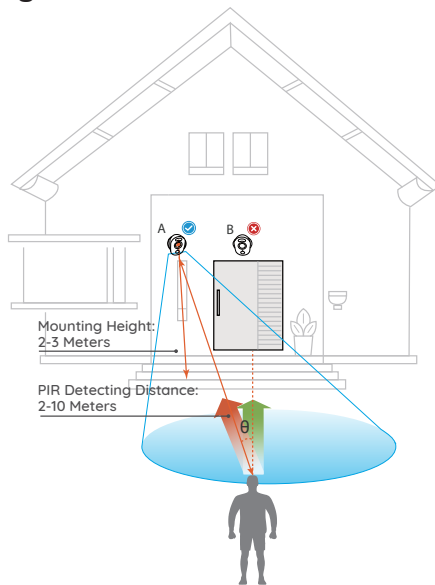



Important Notes for Reducing False Alarms

For reducing false alarms, please note that:

- Do not install the camera facing any objects with bright lights, including sunshine, bright lamplights, etc.
- Do not place the camera too close to a place where there are frequently moving vehicles. The recommended distance between the camera and the vehicle is 15 meters.
- Stay away from the outlets, including the air conditioner vents, humidifier outlets, the heat transfer vent of projectors, etc.
- Do not install the camera facing the mirror.
- Do not install the camera where there are strong winds
- Keep the camera at least 1 meter away from any wireless devices, including Wi-Fi routers and phones in order to avoid wireless interference.

Troubleshooting

Camera is not turning on

If your camera is not turning on, please apply the following solutions:

- Make sure you press and hold the power button on for 3 seconds.
- Charge the camera with a DC 5V/1A power adapter. When the blue light is on, the battery is fully charged.

Fail to scan the QR code on the phone

If the camera failed to scan the QR code on your phone, please apply the following solutions:

- Remove the protective film on the lens of the camera.
- Wipe the camera lens with a dry paper/ towel/tissue.
- Vary the distance (about 30cm) between your camera and the mobile phone which enables the camera to focus better.
- Increase the phone screen brightness and try scanning the QR code.

Wi-Fi connection failed during the initial setup process

If the camera fails to connect to Wi-Fi, please apply the following solutions:

- Please make sure the band of the Wi-Fi network meet the requirement of the camera.
- Please ensure you have entered the correct Wi-Fi password.
- Put your camera close to your router to ensure a strong Wi-Fi signal.
- Change the encryption method of the Wi-Fi network to WPA2 -PSK/WPA -PSK (safer encryption) on your router interface.
- Set your password using only the characters on the keyboard.

Specifications

	Model	App Cam Solo X2K (1, -2, -4)
Video & Audio	Image Sensor	1/2.8" CMOS Image Sensor
	Video Resolution	2304 x 1296 (3.0Megapixel)
	Video Compression	H.264
	Viewing Angle	H 110° / V 60° / D 135°
	PIR Detecting Distance	Up to 10 meters
	PIR Detecting Angle	Horizontal: 120°
	Night Vision	Up to 10 Meters
	Audio	Two-way talk
	Alerts	PIR
	WiFi	WiFi
Wireless Security		64/128-bit WPA/WPA2, WPA-PSK/WPA2-PSK, WPS
Max. User Access		4
Mobile Phone OS		iOS 9 or later, Android 5 or later
Hardware	Battery	Lithium battery 5200mAh
	Storage	Supports up to 256GB micro SD card, min class 10/Cloud storage
Other Parameters	Temperature	Operating Temperature : -20°C~+50°C
	Size & Weight	64 x 59 x 101mm, 265g
	Waterproof Level	IP65 Weatherproof

WARRANTY

Uniden App Cam Solo X2K (1, -2, -4)

Important:

Satisfactory evidence of the original purchase is required for warranty service. Please refer to our Uniden website for any details or warranty durations offered in addition to those contained below.

Warrantor:

The warrantor is Uniden Australia Pty Limited ABN 58 001 865 498 (“Uniden Aust”).

Terms of Warranty: Uniden Aust warrants to the original retail purchaser only that the Uniden App Cam Solo X2K (1, -2, -4) (“the Product”), will be free from defects in materials and craftsmanship for the duration of the warranty period, subject to the limitations and exclusions set out below.

Warranty Period: This warranty to the original retail purchaser is only valid in the original country of purchase for a Product first purchased either in Australia or New Zealand and will expire, as indicated below, from the date of original retail sale.

Product	1 Year
Accessories and Battery	90 Days

If a warranty claim is made, this warranty will not apply if the Product is found by Uniden to be:

- A. Damaged or not maintained in a reasonable manner or as recommended in the relevant Owner’s Manual;
- B. Modified, altered or used as part of any conversion kits, subassemblies or any configurations not sold by Uniden Aust;
- C. Improperly installed contrary to instructions contained in the relevant Owner’s Manual
- D. Repaired by someone other than an authorized Uniden Repair Agent in relation to a defect or malfunction covered by this warranty; or
- E. Used in conjunction with any equipment, parts or a system not manufactured by Uniden.

Parts Covered: This warranty covers the Product and included accessories.

User-generated Data: This warranty does not cover any claimed loss of or damage to user-generated data (including but without limitation phone numbers, addresses and images) that may be stored on your Product.

Statement of Remedy: If the Product is found not to conform to this warranty as stated above, the Warrantor, at its discretion, will either repair the defect or replace the Product without any charge for parts or service. This warranty does not include any reimbursement or payment of any consequential damages claimed to arise from a Product's failure to comply with the warranty.

Our goods come with guarantees that cannot be excluded under the Australian Consumer Law. You are entitled to a replacement or refund for a major failure and for compensation for any other reasonably foreseeable loss or damage. You are also entitled to have the goods repaired or replaced if the goods fail to be of acceptable quality and the failure does not amount to a major failure.

This warranty is in addition to and sits alongside your rights under either the COMPETITION AND CONSUMER ACT 2010 (Australia) or the CONSUMER GUARANTEES ACT (New Zealand) as the case may be, none of which can be excluded.

Procedure for Obtaining Warranty Service: Depending on the country in which the Product was first purchased, if you believe that your Product does not conform with this warranty, you should deliver the Product, together with satisfactory evidence of your original purchase (such as a legible copy of the sales docket) to Uniden. Please refer to the Uniden website for address details. You should contact Uniden regarding any compensation that may be payable for your expenses incurred in making a warranty claim. Prior to delivery, we recommend that you make a backup copy of any phone numbers, images or other data stored on your Product, in case it is lost or damaged during warranty service.

UNIDEN AUSTRALIA PTY LTD

Phone number: 1300 366 895

Email address: custservice@uniden.com.au

THANK YOU FOR BUYING A UNIDEN PRODUCT

© 2024 Uniden Australia Pty Limited v1.1