

Uniden®

iGO CAM 755 **Accident CAM** **Vehicle Recorder**

For more exciting new products please visit our website:
Australia: www.uniden.com.au

OWNER'S MANUAL

Important Safety Instructions



NOTE

Uniden does not represent this product to be waterproof. Do not expose this product to Rain or Moisture.



NOTE

This product is intended for use in a motor vehicle. Don't install the device where it will block the driver's view of the road (including the mirrors!) or the deployment of any airbags.



NOTE

Keep your attention on the road! Don't try to operate or focus on any device while driving. If you have to concentrate on a device, pull off the road for a few minutes.



NOTE

Ensure that the camera lens is kept clean and there is nothing blocking the lens.



NOTE

Don't leave the device in direct sunlight for a long period of time or where the temperature could go above 60°C.

Contents

Important Safety Instructions	2
What Do I Do First?	4
Make Sure These Items Arrived in the Box	4
Controls & Indicators	5
How Do I Put It in My Car?	7
Attaching the Windshield Mount	7
Operation	8
Micro SD Card	8
Plug it in, Power On/Off	9
Record Mode	10
Photo Mode	14
Playback Mode	14
Connecting to a PC	15
iGO CAM Player	15
Special Features	17
Important Information	19
Warranty	20

What Do I Do First?

Make Sure These Items Arrived in the Box



iGO CAM 755



Windshield Mount (with built-in GPS antenna)



DC (CAR) Adaptor



USB Cable



- **Owner's Manual**

- If any item is missing or damaged, contact your place of purchase immediately. ***Never use damaged products!***
- Need help? Get answers at our website: ***www.uniden.com.au*** for Australian model.

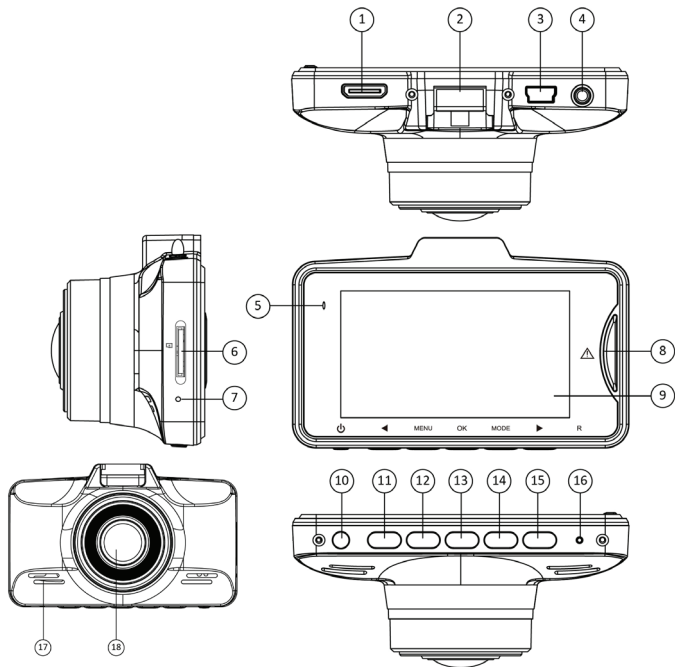
Controls & Indicators



Ref	Component	Description
1	HDMI	HDMI output. Connect using an HDMI cable (not provided).
2	Bracket Slot	Use to insert the windshield mount.
3	USB/DC IN	<ul style="list-style-type: none"> Connect to External Power & charge battery. Connect to PC for data (SD card) transfer.
4	GPS Port	Use to connect the external GPS antenna (included).

5	Power LED indicator	Glows red when the unit is turned on. Glows blue when charging.
6	Micro SD Card Slot	Use this slot to insert the micro SD card.
7	Mic	Records Sound.
8	SOS button	Press to manually lock files.
9	LCD	Display
10	Power	<ul style="list-style-type: none"> • Press to power on the unit. • Press and hold to power off the unit.
11	LEFT 	<p>Function varies with different screens/modes.</p> <ul style="list-style-type: none"> • In Menu list, move the cursor, one line up. • In the Record Mode, press to turn on/off the audio.
12	MENU	<p>Depending on the mode, press to open the Record/Photo/Playback Menu.</p> <p>Press again to open Settings Menu.</p> <p>Press once more to exit the Menu Settings.</p>
13	OK	<p>Acts as an ENTER key</p> <ul style="list-style-type: none"> • In Record mode, press to start or stop video recording. • In Photo mode, press to take a photo. • In Playback mode, press to select a file to view. • Press to confirm a selection in the Menu. • Press to confirm a change in the settings.
14	MODE	<ul style="list-style-type: none"> • Use this button to switch between various modes - Record, Photo and Playback.
15	RIGHT 	In Menu list, move the cursor, one line down.
16	R	If the device fails to operate properly, try resetting the device. Press the reset button by using a fine pen or paperclip.
17	Speaker	
18	Camera Lens	

How Do I Put It in My Car?

Attaching the Windshield Mount

1. Slide the bracket hook into the bracket slot provided on the top of the unit.
2. After inserting the hook, push it down till it locks in position.
3. Press the suction cup flat against the windshield and rotate the suction lock clockwise to secure the unit in place.
4. Gently pull on the mount to make sure it is secure.
5. To remove the unit (including the windshield mount), rotate the suction lock anti-clockwise and gently pull out the suction cup. To detach the unit from the windshield mount pull the lever up and gently pull the unit out.

It maybe a good idea to secure the power cord with cable clips so that it does not interfere while driving.

Avoid rotating the unit at 360° as it might damage the cabling inside.



Suction cups will not stick well on a curved/textured or wet surfaces.

Operation

Micro SD Card



NOTE

A compatible micro SD card has to be inserted before you start using the unit. Ensure that the unit is turned off before inserting or removing the micro SD card.

The unit can support micro SDHC cards (High Capacity SD) up to 64GB in capacity. A micro SDHC card of at least 8GB capacity and minimum speed of Class 10 is recommended.

Insert a formatted micro SD card gently in the slot at the side of the unit. To remove the card from the slot, press the edge of the micro SD card inwards for it to pop out and then pull it out of the slot.

It is important to format the micro SD card before using it, so as to avoid any damage to the files created on iGO CAM 755.

Uniden recommends using good quality micro SD cards.

Battery Information

The unit has an in-built battery of 250mAh capacity.

The iGOCAM 755 is designed mainly for in-vehicle use, drawing on vehicle power and the duration of portable use is limited by the settings and the battery operating time.

The unit will charge the battery whenever power is detected through the USB/DC IN port on the unit or on the bracket.

The unit will take around 3-4 hours to charge completely.



NOTE

Please ensure that the battery is fully charged before using it for the first time. To extend the battery life, charge the unit fully once every 3 months.

Battery Alert

The image given below indicates the battery level at different stages.



Full



Half full



Low



Empty

Plug it in, Power On/Off



NOTE

When connected to a car charger with power, the unit will power on automatically and start recording.

Connect the DC car adaptor to the power connector (USB/DC IN port) found on the device.

Connect the other end of the DC car adaptor to your car's cigarette lighter.

When connected to the car charger the unit will power on automatically and start recording. When the car's engine is turned off, the unit will automatically turn off.

To manually turn the unit on press the POWER button, to turn off press and hold the POWER button for 2-3 seconds.

The GPS  icon on the screen:

- flashes red when the unit hasn't detected the GPS signal
- glows blue when the unit has detected the GPS signal.
- remains gray when the unit is not connected to the GPS antenna.



NOTE

Only use the DC car adaptor that comes with your device. Any other adaptor might damage the device.

Record Mode



NOTE

To record a video, ensure that a valid micro SD card is inserted in the given slot. Though this unit has an internal memory, we recommend that you use a valid micro SD card to record videos.

Using the iGO CAM 755 you can record videos and take photos. To record videos, you need to ensure that the unit is in the Record mode.

Press the MODE button to switch between Record, Photo and Playback modes.

Recording

When connected to a car charger with power, the unit automatically goes into the record mode and starts recording.

A flashing red dot appears at the top right hand of the screen indicating that the unit is recording. To stop recording, press OK and the red dot disappears, indicating that the recording has stopped.

Protect the Current Recording

While recording, if you want to protect the current recordings, then press the SOS button, the  icon will appear on the screen. This indicates that those recordings have been locked and will not be overwritten by new video clips.

Menu Settings



NOTE

Please note, you cannot access MENU in the record mode, when the unit is recording. To access the Menu settings, you will need to stop recording.

Press MENU to open the Record Menu. Press MENU again to open the Settings Menu. Press MENU once more to exit from the Menu settings.

The Left/Right keys can be used to scan through the options, under each menu setting. Press OK to select the required option.

Record Menu

<i>In the Record mode, press MENU to open the Record Menu.</i>	
Item	Description
Resolution	Set the recording resolution. The options available are, 2560x1080 30P, 2304x1296 30P, 1920x1080 30P, HDR_1920x1080 30P, 1280x720 60P and 1280x720 30P
Image Quality	Choose between the options - Super Fine, Fine, Normal - to define the detail in the recordings.
Time Lapse	<p>Time Lapse setting helps you compress a long recording to just under a few seconds. By default, the option is turned off.</p> <p>The options available are Off, Intelligent mode, 0.2sec, 0.5sec, 1sec, 5sec and 30sec.</p> <p>For example, if you opt for 5sec, then an image is captured every 5 seconds. The captured images are then stitched together to playback a high speed video.</p> <p>If you opt for Intelligent mode, the unit will switch to normal recording when it detects movement. However, if no movement is detected for around 3 minutes, then the unit will switch back to time lapse recording.</p>
Metering Mode	This setting allows you to record better videos or capture better images by controlling the manner in which the camera determines the exposure.
Anti-Flicker	Change depending on the electrical power frequency in your area (Default setting is 50Hz and you may not have to change this setting).
Stamp	Opt to have the date, time and car plate number displayed on the recordings.
Loop Record	Use this option to set the length of each video clip. If you choose the option 'Off' then the recorder will not loop record and the files will not be overwritten on the micro SD card.

<p>ADAS Detect</p>	<p>ADAS (Advanced Driver Assistance System) includes the four functions detailed below:</p> <ol style="list-style-type: none"> 1. Lane Departure Warning System (LDWS) - This option alerts you when the vehicle is moving into another lane. 2. Front Collision Warning System (FCWS) - This option alerts you when it detects a possible front collision. 3. Front Vehicle Moving Detection (FVMD) - At the traffic lights when the vehicle in front moves, this option will alert you. 4. Low Light Warning System (LLWS) - This option alerts you in low light environment. <p>However, this option will not function when the speed display or the traffic camera alert is turned on.</p> <p>The ADAS detect feature will not work under the following resolutions; 2304x1296 30P and HDR 1920x1080 30P</p>
<p>ADAS Calibration</p>	<p>The ADAS Detect feature requires correct calibration to capture road markings. Adjust the sensor lines to encompass only the area of the display where road markings can be seen (Page 17).</p>
<p>G Sensor</p>	<p>This functions helps protect/lock video files in case of a sudden movement/collision. You can change the sensitivity level of the G-sensor.</p>
<p>Motion Detection</p>	<p>Enable this setting to allow the unit to record only when it detects movement.</p>
<p>MIC</p>	<p>Opt to turn on or off the audio for the recordings.</p>
<p>Park Mode</p>	<p>When the car engine and the unit is turned off, this mode enables the unit to turn back ON automatically and create a 30sec locked recording when G Sensor picks up vibration. Unit must have sufficient battery power remaining in order to record. The G Sensor must also be turned on.</p>
<p>Live View</p>	<p>Choose to either have LIVE view or the speedometer displayed on the LCD.</p>

Settings Menu

Depending on the mode, press MENU to open the Record/Photo/Playback Menu. Press MENU again to open Settings Menu.

Please Note: Settings Menu is common to all the 3 modes.

Language	Set the language.
SD Card Capacity	Indicates the capacity of the inserted micro SD card.
Car Plate Stamp	Enter the details of your car plate number. Use the Left/Right keys to select a number or an alphabet and press OK to confirm and move to the next character.
Date&Time	Use the Left/Right and the OK buttons to set the date and time.
Time Zone Set	Default is +10.
Format	Use this option to format the micro SD card.
Default	Use to change the settings to the default factory settings.
Auto Power Off	Enable the unit to shut down when it is not recording.
LCD Off	Opt to turn off the LCD to save power.
Delay Power Off	Use this option to keep the unit on for 15secs, 30secs or 1minute even after being disconnected from external power.
Key Tone	Enable or disable this feature to sound a tone or go mute when you press the keys.
Traffic Camera Alert	Please refer to page 17.
Over Speed Alert	Enable this option to receive alerts when over the selected speed limit.
Version	Firmware version

Photo Mode

- Press the MODE button to switch to the photo mode, the  icon will display on the top left corner of the screen.
- Now, press the OK button to take a photo.

In the Photo mode, press MENU to open the Photo Menu. Press MENU again to open the Settings Menu. Press MENU once again to exit the Menu settings. The Left/Right keys can be used to scan through the options, under each menu setting. Press OK to select the required option.

<i>In the Photo mode, press MENU to open the Photo Menu.</i> 	
Item	Description
Photo Resolution	Set the image resolution. The options available are - 4M, 9M, 13M, 16M.
Image Quality	Choose between the options - Super Fine, Fine, Normal - to define the quality of the images.
Stamp	Opt to have the date, time and car plate number displayed on the images.

Playback Mode

Press the MODE button to switch to the playback mode.

Press Menu, the Playback Menu will open with the following two options displayed on the screen.

Playback Mode:

Select this option to play back or repeat one or all of the recorded videos

Delete File

Press OK to select a particular file and then press Menu to reveal the options, Delete this file, Delete all files.

Connecting to a PC

The iGO CAM 755 can be connected to a PC (plug the USB cable (supplied) into the USB/DC IN port).

When the unit is connected to a PC, 'USB Connected' is displayed on the unit's screen.

Select the external drive, and you will notice two folders, EVENT and NORMAL. In the EVENT folder, all the SOS files are stored.

iGO CAM Player

iGO CAM Player allows you to view the recordings on the iGO CAM 755 and trace them on a map.

iGO CAM Player software is supported on Windows XP, Windows 7 and Windows 8.

Installing iGO CAM Player

Download the iGO CAM Player from the Uniden website. You may need to unzip the file using the appropriate archiving software before you can use the player. Double click on the iGO CAM Player icon.

Access the Recorded Files

Before playing the recorded files on the iGO CAM Player, ensure that you can access the files easily.

Either remove the micro SD card from the recorder, and access the card (files) on the computer via a card reader.

or

Connect one end of the USB cable to the recorder and the other end to the USB port on your computer.

View the Recorded Files

To view the recorded files on the iGO CAM Player, follow the steps below:

1. Start the iGO CAM Player (i.e., double click on the iGO CAM Player icon on your desktop, or click windows start and search from the program listing).

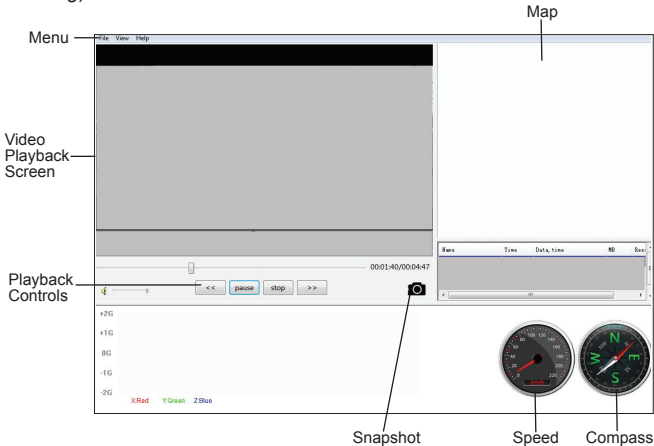

Ensure that the PC is connected to the internet to view the map screen.

2. Click on the option File and select Open to open the files on to the iGO CAM Player.
3. Click on the PLAY button (Playback Controls) to start playback.

Click on the 'Snap Shot' icon to take photos of the recording. These photos will automatically save into a folder named 'screenshot'. This folder is located in the GPS Player folder stored in your PC.



NOTE

GPS Player version is subject to change without notice. See Uniden website to download the latest GPS Player.

Special Features

GPS

The iGO CAM 755 has a GPS antenna, allowing your videos to be geo-tagged. Please ensure that the bracket is fitted on the unit and the GPS antenna is plugged into the GPS port for the unit to be able to detect the GPS signal. You can view the recorded videos on the iGO CAM Player and trace them on a map.

Traffic Camera Alerts

The iGO CAM 755 alerts the user when there is a fixed Speed/Red Light/Red Light-Speed or Average Speed Camera.

For this feature to work, please ensure that the Menu option, Traffic Camera Alert, in the Record mode is turned on.

When the vehicle is close to any of the fixed cameras, the LCD will display the camera alert icon along with specific information. This information will include the distance from the vehicle to the camera, the specified speed limit and the current speed of the vehicle. The display is accompanied by a voice alert.

The cameras alerts will be disabled when the unit loses the GPS signal.

ADAS Calibration

ADAS includes the following 4 functions: LDWS - Lane Departure Warning System, FCWS - Front Collision Warning System, FCMD - Front Vehicle Moving Detection and LLWS - Low Light Warning System.

Ensure to follow the steps listed and read the notes below to get the most out of this feature.

The ADAS detect will not function when the traffic camera alert is turned on or when the live view is turned on to Speed Display. It also won't work under the following resolutions; 2304x1296 30P and HDR 1920x1080 30P.

1. First, ensure that the iGO CAM 755 is mounted and powered on and the vehicle is safely parked.
2. Next, ensure that the Menu option (in the Record Mode) ADAS Detect is turned ON.
3. After that select the Menu option, ADAS Calibration, (Record Mode). You will see 2 sensor lines (Purple and Red) displayed on the screen.
4. Press the MODE button to select either of the sensor lines. Then use the Left and Right keys to position the lines to encompass only the area of the display where road markings can be seen. Please refer to the image on the next page.

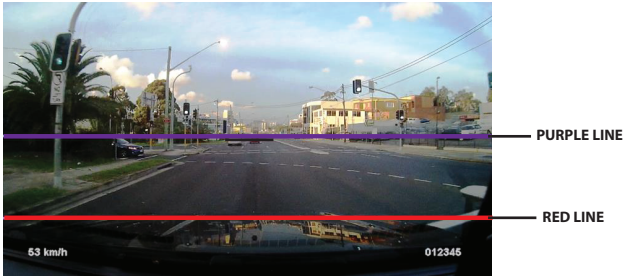

Please Note:

- The ADAS Detect feature requires correct calibration to capture road markings.
- ADAS Detect will be limited in poor visibility or where there is inconsistent or faded road markings.
- Line Calibration is best carried out with the iGO CAM mounted and powered on with the vehicle safely parked.
- ADAS feature is best suited for drivers who spend time on long roads who are worried about falling asleep at the wheel – truck drivers, etc. So the feature is not suited for drivers traversing short roads in city areas where deliberate lane changing is done often.

Important Information

Solving Problems

Listed below are some of the problems and the possible solutions. If you still need help, visit our website, listed on the front cover.

General Problems	Possible Solutions
The unit cannot take photos or record videos. The unit stops automatically when recording.	Use the recommended type of SD card (8GB Class 10) and ensure that is formatted.
The recorded video doesn't show mapping information on the iGO CAM Player.	Please ensure the PC is connected to internet.
Cross-stripe interference in an image	This is due to the light frequency. Change Anti-Flicker setting depending on the local power supply.
The unit crashes	Reset the unit, by pressing the R button.

Warranty

UNIDEN iGO CAM 755

IMPORTANT: Satisfactory evidence of the original purchase is required for warranty service

Please refer to our Uniden website for any details or warranty durations offered in addition to those contained below.

Warrantor: The warrantor is Uniden Australia Pty Limited ABN 58 001 865 498 (“Uniden Aust”).

Terms of Warranty: Uniden Aust warrants to the original retail purchaser only that the iGO CAM 755 (“the Product”), will be free from defects in materials and craftsmanship for the duration of the warranty period, subject to the limitations and exclusions set out below.

Warranty period: This warranty to the original retail purchaser is only valid in the original country of purchase for a Product first purchased either in Australia or New Zealand and will expire one (1) year from the date of the original retail sale.

If a warranty claim is made, this warranty will not apply if the Product is found by Uniden to be:

- (A) Damaged or not maintained in a reasonable manner or as recommended in the relevant Uniden Owner’s Manual;
- (B) Modified, altered or used as part of any conversion kits, subassemblies or any configurations not sold by Uniden Aust;
- (C) Improperly installed contrary to instructions contained in the relevant Owner’s Manual
- (D) Repaired by someone other than an authorized Uniden Repair Agent in relation to a defect or malfunction covered by this warranty; or
- (E) Used in conjunction with any equipment, parts or a system not manufactured by Uniden.

Parts Covered: This warranty covers the Product and included accessories.

User-generated Data: This warranty does not cover any claimed loss of or damage to user-generated data (including but without limitation phone numbers, addresses and images) that may be stored on your Product.

Statement of Remedy: If the Product is found not to conform to this warranty as stated above, the Warrantor, at its discretion, will either repair the defect or replace the Product without any charge for parts or service. This warranty does not include any reimbursement or payment of any consequential damages claimed to arise from a Product's failure to comply with the warranty.

Our goods come with guarantees that cannot be excluded under the Australian Consumer Law. You are entitled to a replacement or refund for a major failure and for compensation for any other reasonably foreseeable loss or damage. You are also entitled to have the goods repaired or replaced if the goods fail to be of acceptable quality and the failure does not amount to a major failure.

This warranty is in addition to and sits alongside your rights under either the COMPETITION AND CONSUMER ACT 2010 (Australia) or the CONSUMER GUARANTEES ACT (New Zealand) as the case may be, none of which can be excluded.

Procedure for obtaining warranty service: Depending on the country in which the Product was first purchased, if you believe that your Product does not conform with this warranty, you should deliver the Product, together with satisfactory evidence of your original purchase (such as a legible copy of the sales docket) to Uniden. Please refer to the Uniden website for address details. You should contact Uniden regarding any compensation that may be payable for your expenses incurred in making a warranty claim. Prior to delivery, we recommend that you make a backup copy of any phone numbers, images or other data stored on your Product, in case it is lost or damaged during warranty service.

UNIDEN AUSTRALIA PTY LTD

Phone: 1300 366 895

Email: custservice@uniden.com.au

Uniden[®]

© 2015 Uniden Australia Pty Limited.
Printed in China