



Uniden®

UH950S
Handheld UHF-CB Transceiver

For more exciting new products please visit our website:
Australia: www.uniden.com.au

OWNER'S MANUAL





Warning

WATERPROOF: JIS7

Uniden's UH950S radio is designed to meet the water proofing standard of JIS7.

This Means:

Being defined as having no ingress of water when immersed at 1 metre for 30 minutes.

The UH950S will only meet this rating if fully assembled and all rubber seals and covers are well maintained and correctly fitted.

This means that the accessory jack cover is inserted, and the battery pack and antenna are attached and securely fastened.

LITHIUM ION BATTERY PACK WARNING

- This equipment contains a Lithium Ion Battery Pack.
- The Lithium Ion Battery Pack contained in this equipment may explode if disposed of in a fire.
- Do not short-circuit the Battery Pack.
- Do not charge the Lithium Ion Battery Pack used in this equipment in any charger other than the one designed to charge this Battery Pack. Using another charger may damage the Battery Pack or cause the Battery Pack to explode.
- Lithium Ion batteries must be disposed off properly.

USER LICENSE INFORMATION



NOTE

The citizen band radio service is licensed in Australia by ACMA Radio-communications (Citizen Band Radio Stations) Class Licence and in New Zealand by MED General User Licence for Citizen Band Radio and operation is subject to conditions contained in those licenses.



Contents

| | |
|---|-----------|
| Introduction | 4 |
| Included in your Package | 5 |
| Controls and Indicators | 6 |
| Getting Started | |
| Connect Drop-in Charger with the AC Adaptor | 7 |
| Attaching the Antenna | 7 |
| Attaching the Battery Pack | 8 |
| Attaching the Beltclip | 8 |
| Charging the Battery Pack | 9 |
| Battery Level Display | 10 |
| Accessory Jack Cover | 11 |
| Connecting the SPKR/MIC | 11 |
| Operation | |
| Power On/Off | 12 |
| Volume | 12 |
| Setting the Squelch | 12 |
| Selecting Channel | 13 |
| To Transmit and Receive | 13 |
| To Operate in Duplex Mode | 14 |
| Transmit Power Select | 15 |
| Boost | 15 |
| Scanning | 15 |
| Master Scan (M.SCN) Mode | 17 |
| Open Scan (OS) Mode | 20 |
| Group Scan (GS) Mode | 21 |
| Priority Channel | 22 |
| Drop-Out Delay | 22 |
| Instant Priority Channel | 22 |
| Monitor | 23 |
| CTCSS | 23 |
| DCS | 24 |
| VOX | 24 |
| Busy Channel Lock-out (BCL) | 25 |
| Call Tone | 25 |
| Roger Beep | 26 |
| Key Beep | 26 |
| Scramble | 26 |
| Keypad Lock | 27 |
| Backlighting | 27 |
| CTCSS Codes and Frequencies | 28 |
| DCS Codes Table | 29 |
| UHF-CB Channel Guidelines | 30 |
| UHF-CB Channels and Frequencies | 31 |
| Warranty | 33 |

Introduction

The UH950S is a JIS7 Waterproof, portable two-way UHF-CB radio. It is compact, rugged and fits easily in your hand. This hand held UHF-CB radio will give you consistent, outstanding performance in virtually all conditions and situations. To ensure that you get the most from the UH950S features, please read this operating guide carefully before using the unit.

FEATURES

- Narrow Band (NB) Radio
- Communicate with up to 80 Channels in the UHF-CB Band¹
- 5W Max TX Power
- 1W/5W Switchable TX Power
- Waterproof (meets JIS7 waterproof specifications)²
- 38 Built-in CTCSS codes & additional 104 DCS codes
- Backlit Keypad & LCD Display
- Instant Channel
- 10 Call Tone
- Boost
- Duplex Mode¹
- Master Scan
- Open and Group Scan
- Busy Channel Lockout Function
- VOX Function
- Headset Jack
- Keypad Lock
- Battery Type: Lithium-Ion Rechargeable
- Low Battery Alert
- Battery strength Indicator
- Auto Battery Save
- Battery Cover with charge contacts
- Roger Beep
- Scramble On/Off

¹ Refer to p.30 - p.32 for channel information

² The UH950S radio meets waterproof (JIS7) specifications only when the battery, the antenna and accessory MIC jack cap are correctly installed. The UH950S will retain its JIS4 rating when the accessory Speaker MIC/Earphone MIC are connected correctly. Accessory Speaker MIC is splashproof (JIS4).



Included in your Package



UH950S



AC Adaptor
(PS-S12C0BL1)



Antenna



Drop-in Charger
(DT950A)

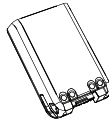

Lithium Ion Battery
(BP950)



External Speaker
Mic (SM-950)



Belt Clip and
Wrist Strap



Earphone Mic
(EM-950)



DC Adaptor



Owner's Manual



NOTE

If any of these items are missing from the box, contact your place of purchase, immediately.

Optional Accessories

- Cigarette Lead Charger with Hang Up Bracket (CK950)



Controls and Indicators

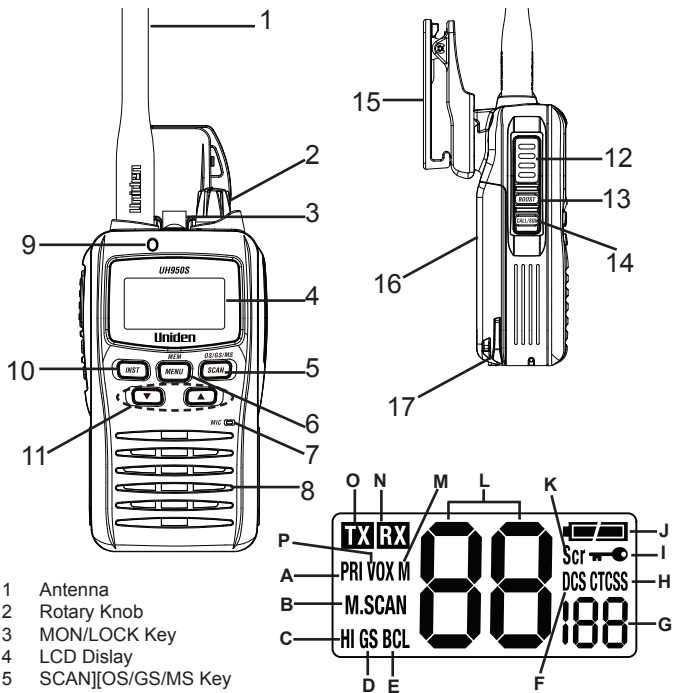

- 1 Antenna
- 2 Rotary Knob
- 3 MON/LOCK Key
- 4 LCD Display
- 5 SCAN][OS/GS/MS Key
- 6 MENU/MEM Key
- 7 Microphone
- 8 Speaker
- 9 LED
- 10 INST Key
- 11 UP and DOWN Keys
- 12 PTT Button
- 13 BOOST Button
- 14 CALL/SQL Button
- 15 Belt Clip
- 16 Battery
- 17 Battery Release Clip

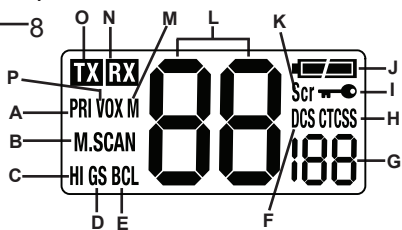

- A Priority
- B Master Scan
- C High Power
- D Group Scanning
- E Busy Channel Lock Out
- F DCS
- G CTCSS/DCS Channel Numbers
- H CTCSS
- I Key Lock
- J Battery Level Indicator
- K Scramble
- L Channel Numbers
- M Memory
- N Receive
- O Transmit
- P VOX

Getting Started

Connect Drop-in Charger with AC Adaptor

Plug one end of the AC adaptor into the wall outlet and the other end into the drop-in charger.

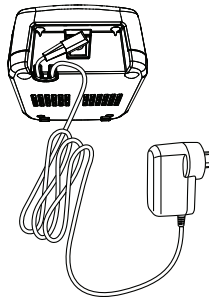

OR...

Connect DC Charging Adaptor to Cigarette Lighter Jack



NOTE

The drop-in charger and DC charging adaptor are not water proof. Ensure the radio is dry before connecting to the charger. Don't use the chargers when the ambient temperature is below 5° C (37° F) or above 40° C (108° F) Input Voltage (Cigarette Lead Charger): +12VDC to+24VDC. If Charge LED didn't light up, please confirm the above temperature.

Attaching the Antenna

Attach the antenna to the UH950S
Be sure the antenna is firmly seated.



Getting Started

Attaching the Battery Pack

1. Place the battery pack onto the back of the radio. It will only fit in one way.
2. Snap the battery release clip until it clicks. Be sure the battery pack fits tightly against the UH950S body.

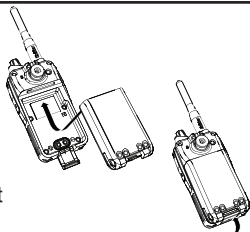

Avoid exposing the Lithium Ion battery, attached or unattached to the radio, in direct sunshine, heated cars, or in areas with temperatures below -20°C (-4°F) or above $+60^{\circ}\text{C}$ ($+140^{\circ}\text{F}$).



Exposing the chemicals contained within the battery pack to temperatures above $+60^{\circ}\text{C}$ ($+140^{\circ}\text{F}$) may cause the battery to rupture, fail or reduce performance.

In case of exposure to cell contents, wash the affected area thoroughly, and seek medical attention.

Additional battery cautions should be applied as described on p.2.

Attaching the Beltclip

1. Hold the beltclip in the direction shown.
2. Apply it to the hanger piece on the back of the radio. Then slide it up.
3. You will hear a click. The beltclip is firmly attached.
4. To take the beltclip off the radio, turn it and slid it up.

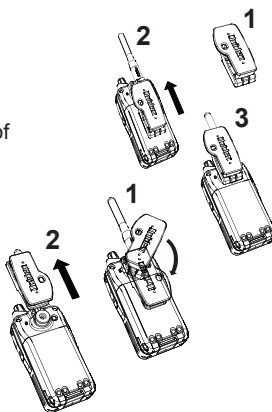

Getting Started

Charging the Battery Pack

Your radio is powered by a specially designed Lithium Ion battery pack.

- Before operating the UH950S, charge the Lithium Ion battery pack for 3 hours without interruption in the drop-in charger.



For the initial battery charge, make sure the radio is off for optimum charging.

The drop-in charger can charge the Lithium Ion battery pack attached to the UH950S, in the front charging slot.

1. Place the UH950S, in the drop-in charger.
2. The red LED illuminates and stays ON, until fully charged.

- The charger won't overcharge the battery packs.

3. The green LED illuminates and stays ON after charging is completed.

- **Do not transmit when the UH950S, is in the drop-in charger!**

- You can monitor incoming calls while the UH950S, is in the drop-in charger.



Getting Started

Battery Level Display

The BATTERY icon at the top of the screen indicates the battery level at all times. The battery level is displayed in 4 levels.

LEVEL 4
Battery 100% full



LEVEL 3
Battery approx.
40% capacity



LEVEL 2
Low Battery



LEVEL 1
(flashing)
Empty Battery

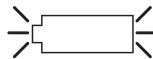

At LEVEL 2, low battery alert will be sounded every 15 minutes.



NOTE

When **(PTT)** or **(BOOST)** is pressed at Level 1, an error tone sounds and transmission is disabled. Once at Level 1 the unit will automatically shutdown after 30 seconds.



NOTE

Recharge the battery at any time. When the battery is empty, it will take up to 3 hours to fully charge.

Battery Life : 27 Hours (Typical)

This is based on the following Duty Cycle:

Transmit (Low Power) 5%
Receive 5%
Stand-by 90%

LED Status

| LED | What it Indicates |
|-------|---------------------|
| Green | Start Up/Power on |
| Green | Monitor mode |
| Green | Receiving Signal |
| Red | Transmitting signal |

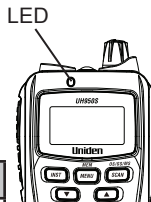

Getting Started

Accessory Jack Cover

Make sure the Accessory Jack Cover is firmly pushed in and its screws are firmly tightened to maintain submersible rating.

Connecting the SPKR/MIC

Release the Accessory Jack Cover to plug in the SPKR/MIC. Secure the SPKR/MIC plug by tightening the plug collar clockwise with your fingers.

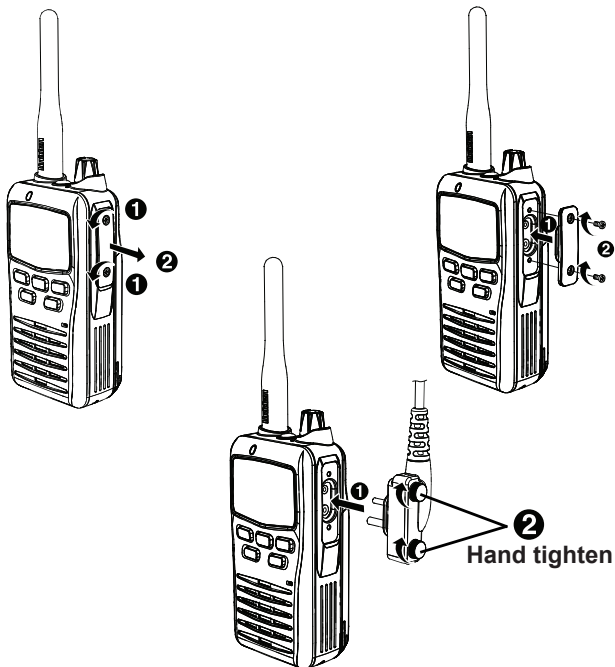

It is recommended to use your fingers instead of any tool to tighten the screws.

Operation

Power On/Off

1. To turn the unit **ON**, rotate the **[ON/OFF VOL]** knob clockwise. A channel number and battery level should appear on the display.
2. To turn the unit **OFF**, rotate the **[ON/OFF VOL]** knob counter-clockwise. The display will disappear.

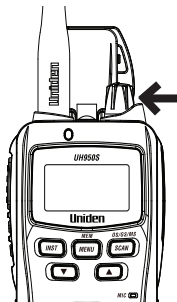

Volume

Rotate the **[ON/OFF VOL]** knob clockwise or counter-clockwise to adjust speaker volume to desired listening level.

Setting The Squelch

The squelch is used to eliminate any annoying background noise when there are no signals present.

Auto/Sq 1 - max sensitivity (min squelch)

Sq 5 - min sensitivity (max/tight squelch)

1. Press and hold **[CALL/SQL]** . **Sq** and the current squelch level will flash on the display.
2. Use **▲** or **▼** to change the squelch level from Auto/1 to 5.
3. Press **[CALL/SQL]** to confirm the setting.

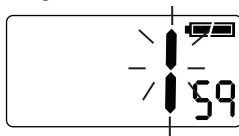

Operation

Selecting A Channel

Press ▲ or ▼ to select the desired channel.



NOTE

If you press and hold ▲ or ▼ the channel numbers will scroll rapidly.

To Transmit And Receive

The radio uses the UHF-CB Channels. For your reference a list of the available channels and corresponding frequencies is printed on p.31 - p.32. (Channels 22 and 23 are for telemetry and telecommand applications, channels 61, 62 and 63 are for future use. TX is inhibited on these channels.)

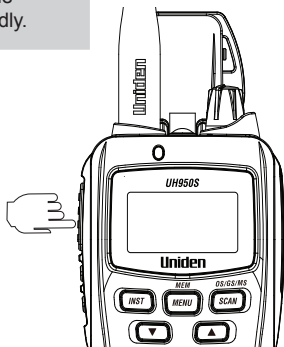

The maximum RF transmit power of UH950S is 5W. (see Transmit Power Select, p.15.)

1. Before you transmit, listen for activity on the selected channel.
2. When the channel is clear;
 - Press **[PTT]** to transmit at the selected hi/lo transmit power,
 - or
 - Press **[BOOST]** to transmit at the maximum transmit power, regardless of the hi/lo transmit power setting.

TX appears on the LCD during transmit. If transmit power is on low setting then **HI** appears when **[BOOST]** is pressed.

Hold the radio with microphone approximately 5 cm in front of your mouth with the antenna at approximately 45° angle away from your head. Speak in a clear, normal conversational voice.

4. When you have finished speaking, release **[PTT]** or **[BOOST]** and listen for a response then TX disappears on the LCD. **RX** appears while receiving a signal.

Operation

To Operate In Duplex Mode (Repeaters)

The Duplex function enables you to access local repeater stations.



You can only activate Duplex on CH01-CH08 and CH41-CH48.

UHF CB Repeaters are used to retransmit or relay your signal. Repeaters will extend the range of your radio and overcome the shielding effect caused by solid obstructions.

Eg. CH01 is being used in your area for repeater use.

1. Press **[MENU/MEM]** four times.
2. Press **▲** or **▼** to change the selection. **r** appears for CH01-CH08 and **n** appears for CH41-CH48 when duplex is selected.
3. Press & hold **[MENU/MEM]** to save and exit.

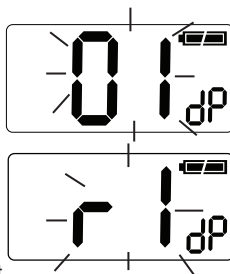

Contact your retailer for a list of repeaters available in your area.

Operation with the aid of a Repeater

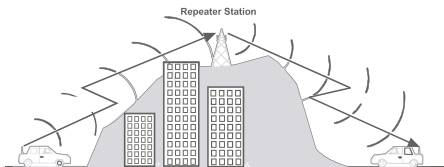

Operation

Transmit Power Select

The UH950S has two transmit power levels: Hi: 5.0 Watt and Lo: 1.0 Watt.

To change your transmit power level:

1. Press **[MENU/MEM]**.
2. Press **▲** or **▼** to change the setting to **Hi** or **Lo**.
3. Press & hold **[MENU/MEM]** to save and exit.

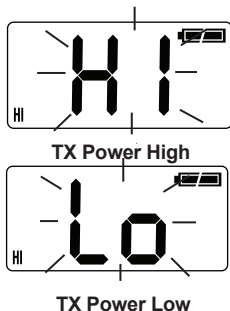

Boost Feature

Use the Boost feature by pressing (**BOOST**) instead of (**PTT**) to transmit at maximum transmit power (5W) regardless of the transmit hi/lo setting.



NOTE

Transmitting on a higher level will use more Battery power but will enable you to transmit further.

Scanning

Press and hold the **[SCAN| OS/GS/MS]** key.

There are 3 scanning modes;

Open Scan (OS),

Group Scan (GS) and

Master Scan (M.SCN) (a special case of Group Scan).

During SCAN the UH950S only checks channels or frequencies that are in the SCAN Memory, which are indicated by the M (memory) icon. The UH950S maintains two SCAN Memories; one for Open Scan (OS) mode and the other for Group Scan (GS) mode, to give you flexibility and allow you to use the radio more effectively.



NOTE

Group Scan and Master Scan modes share the same SCAN Memory.

Operation

To initiate scanning,

1. Press **[SCAN| OS/GS/MS]** to start Scanning.
2. The SCAN icon flashes.
3. The scan direction can be changed at any time by pressing ▼ or ▲.
4. Press **[SCAN| OS/GS/MS]** to stop Scanning.

To select scan mode,

Press and hold the **[SCAN| OS/GS/MS]** key.

M.SCAN icon appears on the display.

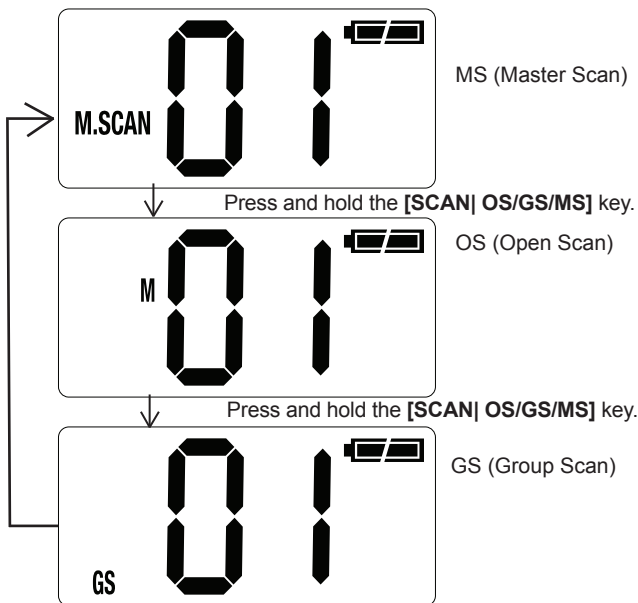



Operation

Add/Remove Channels from Memory

1. Select which Scanning Mode you wish to use on the channel OS, GS or M.SCAN Mode.



OS is indicated by the absence of the GS or M.SCAN icon.

2. Select the channel you want to store by pressing ▼ or ▲.
3. Press and hold **[MENU/MEM]** to store.
4. To remove the channel from Memory, Press and hold **[MENU/MEM]** to remove. M icon disappears.

MASTER SCAN Mode

MASTER SCAN is the default scan mode and is enabled to allow continual communication across congested channels.

Master Scan scans channels stored into GS Memory and only opens the squelch for signals with the correct subcode (CTCSS or DCS tone).

To achieve this, all radios in your group must have the same channels in GS memory (group channels) and use the same Subcode (CTCSS or DCS tone).

By scanning only group channels, radios in the network will be able to detect and receive group transmissions- continual communication without interruption. When transmitting in this mode, the radio switches to an unused group channel if it detects another signal with no code, or the wrong code, on the channel last used by the group. In this way, all group users will be able to have continual communication to or from other users.

CH09-CH20 are stored into GS Memory and CTCSS01 is set for MASTER SCAN Subcode by default. The GS memory can be changed,



Operation

channel by channel, if desired, but for Master Scan to work effectively each radio in the group must have the same channels in its GS memory.

To add/remove channels from GS SCAN Memory, refer the section above.

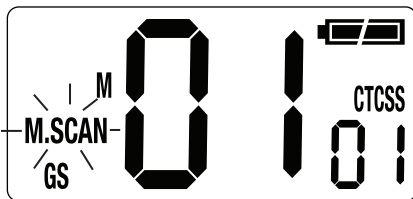

RX only Channels (CH22, CH23, CH61, CH62 and CH63) will not be included in MASTER SCAN Mode even though stored into GS Memory. Also channels for which Duplex Setting are On will be skipped in MASTER SCAN Mode.

To operate in **MASTER SCAN** mode,

1. Press **[MENU/MEM]** key six times.
The M.SCAN setting flashes.
2. Change to the following setting by pressing ▼ or ▲.

P-: No change for GS memory
P1: Master Scan is ON with loading CH09-20 in GS.
P2: Master Scan is ON with loading CH21-30, 39, 40 in GS.
P3: Master Scan is ON with loading CH49-60 in GS.
P4: Master Scan is ON with loading CH61-70, 79, 80 in GS.

Operation

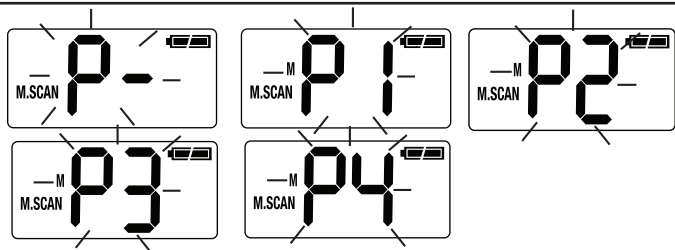

3. Press **[MENU/MEM]** one more time.
4. Select the desired Subcode (CTCSS DCS) or by pressing **▼** or **▲**.

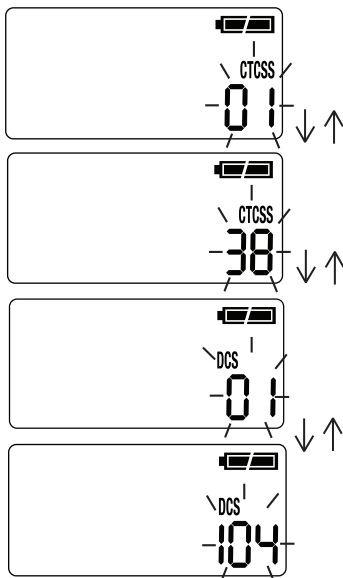

Operation

5. Press and hold the **[MENU/MEM]** to save and exit from the Menu Mode.



If a button is not pressed within 10 seconds the UHF CB Radio will automatically exit the Menu Mode.

Open Scan (OS) Mode

All UHF-CB have been added to the OS SCAN Memory for convenience. To add/remove channels from OS SCAN Memory, refer to p.17.

Allows continuous scanning of all selected channels. If an active channel is found, scanning will stop on that channel. If the received signal ceases, the unit will wait 2 seconds for the signal to return, otherwise scanning resumes.

After transmission in scan mode, the scan mode will be cancelled.

To select OS scan mode,

Press and hold the **[SCAN] OS/GS/MS]** key.



OS Mode is indicated by the absence of the GS icon.



If SCAN is deactivated while on an active channel, the UH950S will stay on that active channel. If no channels are active, the UH950S will reinstate the starting channel.



Operation

Group Scan (GS) Mode

GS Mode has CH09 to CH20 in the SCAN Memory by default. Channels must be stored to the GS SCAN Memory before group scan can start. To add/remove channels from GS SCAN Memory, refer to p.17.

Includes the accessory feature Priority Watch which allows you to monitor the Instant Priority Channel while scanning (see p.22 for setting Instant Priority Channel and p.22 to turn on Priority Watch).

If scanning stops on a channel which is not a Priority Channel, UHF CB Radio will continue monitoring the Priority Channel for activity while listening to the active one.

To select GS scan mode,

Press and hold the **[SCAN] OS/GS/MS** key. GS icon appears on the display.





Operation

Priority Channel Watch During Group Scan

The feature allows user to monitor the Instant Priority channel every 1.5 seconds during Group Scanning.

1. Press **[MENU/MEM]** five times. **PRI** setting flashes.
2. Press **▲** or **▼** to change the setting on or off.
3. Press & hold **[MENU/MEM]** to save and exit.

Drop-Out Delay

While scanning, the radio stops at a busy channel and receives a signal. When the received signal is over, the unit will wait for 2 seconds for the return of the signal, otherwise, the radio resumes scanning.



Programming the Instant Priority Channel

Select the Channel you want to store as the Instant Priority Channel by pressing **▲** or **▼**.

Press and hold **[INST]** for 1.5 seconds to program the channel. **PRI** icon appears.

Recalling the Instant Channel

Momentarily press the **[INST]** button to return to the Instant Channel.



Operation

Monitor

This feature enables users to listen in for weak signals on the current channel at the press of a button.

To use monitor,

- For continuous listening.
Press **[MON/LOCK]**.

A beep tone will be heard and the receiver circuit will stay open, letting in both the noise & weak signals.

- **RX** flashes.
- To return to normal receive mode press **[MON/LOCK]**.

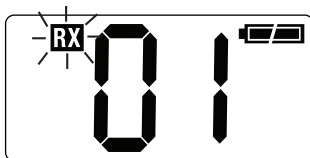

CTCSS

CTCSS is a feature that allows a group to talk to each other without hearing other users on the same channel.

1. Select desired channel.
2. Press **[MENU/MEM]** two times.
DCS/CTCSS setting flashes.
3. Press **▲** or **▼** to change the selection.

4. Press & hold **[MENU/MEM]** to save and exit.

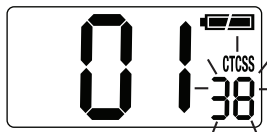
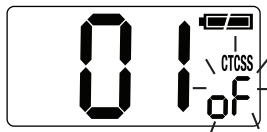

NOTE

Select **oF** to turn DCS/CTCSS off for the selected channel.

Operation

DCS

DCS is a digital extension of CTCSS. It provides 104 extra, digitally coded, squelch codes that follow after the 38 CTCSS codes. CTCSS 1-38, followed by DCS 1-104.

Follow the steps for changing CTCSS code but select DCS code as desired.

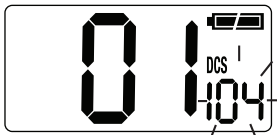
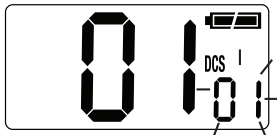

Channels 05 and 35 are used for emergency channels. CTCSS and DCS will not operate on these two channels.

VOX

VOX is the automatic transmitting function without pressing the PTT key.

VOX appears when VOX level setting is from 1 to 5.

1. Press **[MENU/MEM]** eight times.
VOX setting flashes.
2. Press **▲** or **▼** to select the desired setting.
The 6 VOX levels are from 1 (low sensitivity) to 5 (high sensitivity) and Off.
3. Press & hold **[MENU/MEM]** to save and exit.

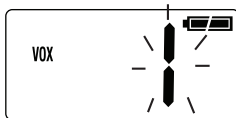

Operation

Busy Channel Lockout

This feature prevents accidental transmission on a busy channel. For example, BCL is used when CTCSS or DCS is selected to prevent transmission when the radio detects a transmission from another unit using the same CTCSS or DCS code.

1. Press **[MENU/MEM]** nine times. **BCL** setting flashes.
2. Press **▲** or **▼** to change the setting on or off.
3. Press & hold **[MENU/MEM]** to save and exit.



Call Tone

Your UH950S radio is equipped with 10 selectable call tones that will be transmitted when **[CALL/SQL]** is pressed.

1. Press **[MENU/MEM]** 10 times. **CL** setting flashes.
2. Press **▲** or **▼** to change the selection.
The 10 call tones are CL 1 to CL 10. A sample of the call tone is sounded when selected.
3. Press & hold **[MENU/MEM]** to save and exit.



Current regulations require calling tones to be restricted to one transmission per minute. If a second transmission is attempted within one minute then an error tone will sound.

Operation

Roger Beep

Roger Beep is a BEEP that is sent to notify the end of transmission (both PTT and VOX transmission.) Roger Beep can be heard through the speaker when Key Beep is on. Roger Beep is transmitted even if Key Beep is turned off. However, Roger Beep will not be heard from the speaker.

1. Press **[MENU/MEM]** 11 times.
rb setting flashes.
2. Press **▲** or **▼** to change the setting on or off.
3. Press & hold **[MENU/MEM]** to save and exit.

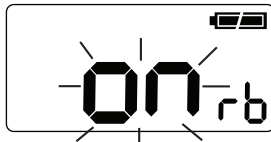

Key Beep

Assures the user that the keypad has been properly pressed by emitting a beep tone. This tone can be switched on or off.

1. Press **[MENU/MEM]** 12 times.
bP setting flashes.
2. Press **▲** or **▼** to change the setting on or off.
3. Press & hold **[MENU/MEM]** to save and exit.

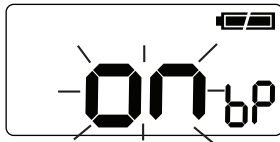

Scramble

Scramble enables private communications by scrambling the voice signal. This prevents users without descrambler equipment or a compatible unit from understanding the conversation. Select desired channel.

Scr appears when Scramble setting is from 1 to 5.

1. Press **[MENU/MEM]** 3 times. The Scramble setting flashes.

Operation

2. Press ▲ or ▼ to select the desired Scramble setting (Off, 1-5).
3. Press & hold **[MENU/MEM]** to save and exit.

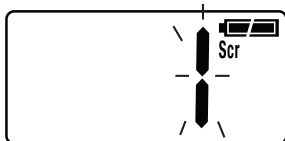

For safety purposes Scramble is invalid on channel 5, 11 and 35.

Keypad Lock

To prevent accidental entries, you can lock the keypad. Press and hold **[MON/LOCK]** for 1.5 seconds until it beeps to activate Key Lock. The  appears.

To unlock the keypad, press and hold **[MON/LOCK]** again for 1.5 seconds. The  disappears.



When the keypad Lock is active, an error tone will be heard if you attempt to press any key, except for the following key functions; **(PTT)** and **(BOOST)**.

Back Lighting

The Liquid Crystal Display (LCD) is backlit for easy viewing at night or in low light situations. The back lighting automatically switches ON every time a key (except PTT and BOOST) is pressed. It turns OFF 5 seconds after the last key is pressed.

CTCSS Codes and Frequencies

| Code No. | Frequency (Hz) | Code No. | Frequency (Hz) |
|----------|----------------|----------|----------------|
| "oF" | OFF | 20 | 131.8 |
| 1 | 67.0 | 21 | 136.5 |
| 2 | 71.9 | 22 | 141.3 |
| 3 | 74.4 | 23 | 146.2 |
| 4 | 77.0 | 24 | 151.4 |
| 5 | 79.7 | 25 | 156.7 |
| 6 | 82.5 | 26 | 162.2 |
| 7 | 85.4 | 27 | 167.9 |
| 8 | 88.5 | 28 | 173.8 |
| 9 | 91.5 | 29 | 179.9 |
| 10 | 94.8 | 30 | 186.2 |
| 11 | 97.4 | 31 | 192.8 |
| 12 | 100.0 | 32 | 203.5 |
| 13 | 103.5 | 33 | 210.7 |
| 14 | 107.2 | 34 | 218.1 |
| 15 | 110.9 | 35 | 225.7 |
| 16 | 114.8 | 36 | 223.6 |
| 17 | 118.8 | 37 | 241.8 |
| 18 | 123.0 | 38 | 250.3 |
| 19 | 127.3 | | |

DCS Codes Table

| Code No. | DCS Code (Octal) | Code No. | DCS Code (Octal) | Code No. | DCS Code (Octal) |
|----------|------------------|----------|------------------|----------|------------------|
| 1 | 023 | 36 | 223 | 71 | 445 |
| 2 | 025 | 37 | 225 | 72 | 446 |
| 3 | 026 | 38 | 226 | 73 | 452 |
| 4 | 031 | 39 | 243 | 74 | 454 |
| 5 | 032 | 40 | 244 | 75 | 455 |
| 6 | 036 | 41 | 245 | 76 | 462 |
| 7 | 043 | 42 | 246 | 77 | 464 |
| 8 | 047 | 43 | 251 | 78 | 465 |
| 9 | 051 | 44 | 252 | 79 | 466 |
| 10 | 053 | 45 | 255 | 80 | 503 |
| 11 | 054 | 46 | 261 | 81 | 506 |
| 12 | 065 | 47 | 263 | 82 | 516 |
| 13 | 071 | 48 | 265 | 83 | 523 |
| 14 | 072 | 49 | 266 | 84 | 526 |
| 15 | 073 | 50 | 271 | 85 | 532 |
| 16 | 074 | 51 | 274 | 86 | 546 |
| 17 | 114 | 52 | 306 | 87 | 565 |
| 18 | 115 | 53 | 311 | 88 | 606 |
| 19 | 116 | 54 | 315 | 89 | 612 |
| 20 | 122 | 55 | 325 | 90 | 624 |
| 21 | 125 | 56 | 331 | 91 | 627 |
| 22 | 131 | 57 | 332 | 92 | 631 |
| 23 | 132 | 58 | 343 | 93 | 632 |
| 24 | 134 | 59 | 346 | 94 | 654 |
| 25 | 143 | 60 | 351 | 95 | 662 |
| 26 | 145 | 61 | 356 | 96 | 664 |
| 27 | 152 | 62 | 364 | 97 | 703 |
| 28 | 155 | 63 | 365 | 98 | 712 |
| 29 | 156 | 64 | 371 | 99 | 723 |
| 30 | 162 | 65 | 411 | 100 | 731 |
| 31 | 165 | 66 | 412 | 101 | 732 |
| 32 | 172 | 67 | 413 | 102 | 734 |
| 33 | 174 | 68 | 423 | 103 | 743 |
| 34 | 205 | 69 | 431 | 104 | 754 |
| 35 | 212 | 70 | 432 | | |



UHF-CB Channel Guidelines



NOTE

Always listen on a channel (or observe the receive signal level meter) to ensure it is not already being used before transmitting.

Channels 5 and 35 are used for emergency channels. CTCSS, DCS will not operate on these channels.

Please follow these guidelines for channel use in Australia:

- Channels 05 and 35 are Emergency Channels.
- Channel 11 is a Calling Channel.
- Channels 22 and 23 are for telemetry and telecommand applications, channels 61, 62 and 63 are for future use and TX is inhibited on these channels.

General communication is accepted on all other channels with these guidelines:

- Channel 40 - road channel (Australia).
- Channels 01-08 (and 31-38), and Channels 41-48 (and 71-78) are repeater channels.

Important information - 80 Channel UHF-CB channel expansion

To provide all users additional channel capacity within the UHF-CB Band. The ACMA will change the majority of the current wideband 40 channel use to narrowband channel use. This allows for additional channels to be added, up to 80 Channels.

This simply means that the new narrowband radio you have purchased will have more channels than older radios. Please refer to the guidelines above and the channel chart for further channel information.

A list of currently authorised channels can also be obtained from the ACMA website in Australia and the MBIE website in New Zealand.



NOTE

Interference / Poor Audio

When a new narrowband radio receives a signal from an older wideband radio the speech may sound loud.

Narrowband radios operating on CH41 - CH80 may encounter interference from a nearby wideband radios transmitting on high power on an adjacent channel (frequency).

When an older wideband radio receives a signal from a new narrowband radio the speech may sound quiet - the wideband radio user simply adjusts their radio volume for best performance.

The above situations are not a fault of the radio but a symptom of mixed wideband and narrowband radios in current use. It is expected that as older wideband radios are phased out this issue will be eliminated.



UHF-CB Channels and Frequencies

| CH No. | Simplex Mode Transmit / Receive Frequency (MHz) | Duplex Mode Transmit Frequency (MHz) | CH No. | Simplex Mode Transmit / Receive Frequency (MHz) |
|--------|---|--------------------------------------|--------|---|
| 1 | 476.425 | 477.175 (CH31) | 21 | 476.925 |
| 2 | 476.450 | 477.200 (CH32) | 22 | 476.950 (RX only) |
| 3 | 476.475 | 477.225 (CH33) | 23 | 476.975 (RX only) |
| 4 | 476.500 | 477.250 (CH34) | 24 | 477.000 |
| 5 | 476.525 | 477.275 (CH35) | 25 | 477.025 |
| 6 | 476.550 | 477.300 (CH36) | 26 | 477.050 |
| 7 | 476.575 | 477.325 (CH37) | 27 | 477.075 |
| 8 | 476.600 | 477.350 (CH38) | 28 | 477.100 |
| 9 | 476.625 | | 29 | 477.125 |
| 10 | 476.650 | | 30 | 477.150 |
| 11 | 476.675 | | 31 | 477.175 |
| 12 | 476.700 | | 32 | 477.200 |
| 13 | 476.725 | | 33 | 477.225 |
| 14 | 476.750 | | 34 | 477.250 |
| 15 | 476.775 | | 35 | 477.275 |
| 16 | 476.800 | | 36 | 477.300 |
| 17 | 476.825 | | 37 | 477.325 |
| 18 | 476.850 | | 38 | 477.350 |
| 19 | 476.875 | | 39 | 477.375 |
| 20 | 476.900 | | 40 | 477.400 |

UHF-CB Channels and Frequencies

| CH No. | Simplex Mode Transmit / Receive Frequency (MHz) | Duplex Mode Transmit Frequency (MHz) | CH No. | Simplex Mode Transmit / Receive Frequency (MHz) |
|--------|---|--------------------------------------|--------|---|
| 41 | 476.4375 | 477.1875 (CH 71) | 61 | 476.9375 (RX only) |
| 42 | 476.4625 | 477.2125 (CH 72) | 62 | 476.9625 (RX only) |
| 43 | 476.4875 | 477.2375 (CH 73) | 63 | 476.9875 (RX only) |
| 44 | 476.5125 | 477.2625 (CH 74) | 64 | 477.0125 |
| 45 | 476.5375 | 477.2875 (CH 75) | 65 | 477.0375 |
| 46 | 476.5625 | 477.3125 (CH 76) | 66 | 477.0625 |
| 47 | 476.5875 | 477.3375 (CH 77) | 67 | 477.0875 |
| 48 | 476.6125 | 477.3625 (CH 78) | 68 | 477.1125 |
| 49 | 476.6375 | | 69 | 477.1375 |
| 50 | 476.6625 | | 70 | 477.1625 |
| 51 | 476.6875 | | 71 | 477.1875 |
| 52 | 476.7125 | | 72 | 477.2125 |
| 53 | 476.7375 | | 73 | 477.2375 |
| 54 | 476.7625 | | 74 | 477.2625 |
| 55 | 476.7875 | | 75 | 477.2875 |
| 56 | 476.8125 | | 76 | 477.3125 |
| 57 | 476.8375 | | 77 | 477.3375 |
| 58 | 476.8625 | | 78 | 477.3625 |
| 59 | 476.8875 | | 79 | 477.3875 |
| 60 | 476.9125 | | 80 | 477.4125 |



Warranty

UNIDEN UH950S UHF CB Transceiver

IMPORTANT: Satisfactory evidence of the original purchase is required for warranty service

Please refer to our Uniden website for any details or warranty durations offered in addition to those contained below.

Warrantor: The warrantor is Uniden Australia Pty Limited ABN 58 001 865 498 (“Uniden Aust”).

Terms of Warranty: Uniden Aust warrants to the original retail purchaser only that the UH950S (“the Product”), will be free from defects in materials and craftsmanship for the duration of the warranty period, subject to the limitations and exclusions set out below.

Warranty period: This warranty to the original retail purchaser is only valid in the original country of purchase for a Product first purchased either in Australia or New Zealand.

| | |
|----------------------------|---------|
| Product | 3 Years |
| Battery Pack & Accessories | 1 Year |

If a warranty claim is made, this warranty will not apply if the Product is found by Uniden to be:

- (A) Damaged or not maintained in a reasonable manner or as recommended in the relevant Uniden Owner’s Manual;
- (B) Modified, altered or used as part of any conversion kits, subassemblies or any configurations not sold by Uniden Aust;
- (C) Improperly installed contrary to instructions contained in the relevant Owner’s Manual
- (D) Repaired by someone other than an authorized Uniden Repair Agent in relation to a defect or malfunction covered by this warranty; or
- (E) Used in conjunction with any equipment, parts or a system not manufactured by Uniden.

Parts Covered: This warranty covers the Product and included accessories.

User-generated Data: This warranty does not cover any claimed loss of





Warranty

or damage to user-generated data (including but without limitation phone numbers, addresses and images) that may be stored on your Product.

Statement of Remedy: If the Product is found not to conform to this warranty as stated above, the Warrantor, at its discretion, will either repair the defect or replace the Product without any charge for parts or service. This warranty does not include any reimbursement or payment of any consequential damages claimed to arise from a Product's failure to comply with the warranty.

Our goods come with guarantees that cannot be excluded under the Australian Consumer Law. You are entitled to a replacement or refund for a major failure and for compensation for any other reasonably foreseeable loss or damage. You are also entitled to have the goods repaired or replaced if the goods fail to be of acceptable quality and the failure does not amount to a major failure.

This warranty is in addition to and sits alongside your rights under either the COMPETITION AND CONSUMER ACT 2010 (Australia) or the CONSUMER GUARANTEES ACT (New Zealand) as the case may be, none of which can be excluded.

Procedure for obtaining warranty service: Depending on the country in which the Product was first purchased, if you believe that your Product does not conform with this warranty, you should deliver the Product, together with satisfactory evidence of your original purchase (such as a legible copy of the sales docket) to Uniden at the address shown below. You should contact Uniden regarding any compensation that may be payable for your expenses incurred in making a warranty claim. Prior to delivery, we recommend that you make a backup copy of any phone numbers, images or other data stored on your Product, in case it is lost or damaged during warranty service.

UNIDEN AUSTRALIA PTY LTD

Service Division
345 Princes Highway,
Rockdale, NSW 2216
Phone: 1300 366 895
Email: custservice@uniden.com.au





THANK YOU FOR BUYING A UNIDEN PRODUCT.

Uniden®

© 2014 Uniden Australia Pty Limited. Printed in Vietnam.
U01UT963ZZA(0)