

Uniden®

UH9060/UH9080 **Remote Speaker MIC** **UHF CB Transceiver**

For more exciting new products please visit our website:
Australia: www.uniden.com.au

OWNER'S MANUAL

Contents

Introduction	4
Controls & Connectors	5
Indicators	7
Included with your UH9060/UH9080 Transceiver	8
Optional Accessories	9
Connecting the Microphone	10
Slide Mount Bracket	11
Mounting the MIC Hanger	13
Operation	15
Turning on the Power	15
Setting the Auto Squelch	16
Smart-Key Function	16
Voice Enhancer (EQL) Setting	17
Programming the Instant Priority Channel-1	17
Programming the Instant Priority Channel-2	17
Recalling the Instant Channel	17
Selecting a Channel	18
Channel Banks - Using the POLICE button (Only for UH9080)	18
Triple Watch	19
Transmitting	19
CTCSS (Continuous Tone Coded Squelch System)	20
DCS (Digital Coded Squelch)	20
Call Tone	21
Using Repeater Channels	21
Operating the UHF CB Radio in Duplex Mode	22
Scanning	23
Add/Remove Channels from SCAN Memory	23
MASTER SCAN Mode	23
Open Scan (OS) Mode	25
Group Scan (GS) Mode	26
Priority Watch	27
Busy Channel Lockout	28
Roger Beep	28
Key Beep On/Off	29
Alpha Tag	29
Volume Sync	30
Backlight Colour	30
Backlight Level	31
LCD Contrast	31
Scramble On/Off (Only for UH9080)	31
Operation - Special Features	32
Instant Replay	32
Turning Instant Replay On/Off	32

Contents

100 User Programmable RX Channels (Only for UH9080)	33
Manually Programme a RX Channel (Only for UH9080)	33
Search Extra Channel Range and Programme a RX Channel (Only for UH9080)	34
Store a Police/Fire frequency to a RX Channel (Only for UH9080)	35
Store a frequency found using CLOSE CALL to a RX Channel (Only for UH9080)	35
Close Call RF Capture (Only for UH9080)	36
Using Close Call (Only for UH9080)	37
Selective Calling	38
Programming the Selcall ID for your UH9060/UH9080	39
Storing Selcall IDs of other users to the ID Memory	39
Tone Calling (Making a Selcall Call)	40
Receiver Quiet (TSQ) Mode	40
To Activate/Deactivate Tone Squelch (TSQ) on a Channel	41
Receiving a Selcall	41
Scanning Tone Squelched Channels	42
Group Calling	43
Selcall ID Format	43
Selcall Settings	44
Tone Period	44
Lead-in Delay	44
Lead-in Delay Programming	45
Lead-in Tone	45
Alarm Mode	46
Call Alarm Auto Mode	46
Call Alarm Continue Mode	46
Group Call Mode	46
SELCALL Tone Frequency List	47
CTCSS Codes Table	47
DCS Codes Table	48
Channel Bank List - Police (POL) (Only for UH9080)	49
Channel Bank List - Fire (Only for UH9080)	50
UHF CB Channel Guidelines	51
UHF CB Channels & Frequencies	52
Warranty	54

Introduction

The Uniden UH9060/UH9080 is designed to provide you with years of trouble free service. Its rugged components and materials are capable of withstanding harsh environments. Please read this Operating Manual carefully to ensure you gain the optimum performance of the unit.



The citizen band radio service is licenced in Australia by ACMA Radio-communications (Citizen Band Radio Stations) Class Licence and in New Zealand by MBIE General User Licence for Citizen Band Radio and operation is subject to conditions contained in those licenses.

Features

- UHF-CB Narrow Band (NB) Transceiver Radio¹
- 80 Channel
- 5W Transmission Power
- Built-in AVS Circuitry³
- Duplex Capability¹
- Built-in Selective Calling (SELCALL) Feature with Alpha Tag
- Roger Beep Function On/Off
- 10 Different Call Tones

Special Features

- 100 Extra User Programmable Receive Only Channels with Alpha Tag^{2,4}
- Pre-Programmed Police, Fire & Ambulance Frequencies^{2,4}
- Instant Replay of Recent Received Signals
- Close Call™ RF Capture Feature^{2,4}
- One-Touch Smart Key
- Voice Enhancer (EQL)
- 2 Voice Scramble Settings⁴

Control Features

- Remote LCD Speaker Microphone (Remote SPK/MIC) with Extension Cable
- LCD Display with 7 Backlight Colours
- LCD Brightness & Contrast control
- Slide Mount Bracket
- +12V to +24V DC Power Input
- Under and over voltage alert function

- Signal Strength/ Power Meter
- Volume Control
- Base & Remote Mic Speakers
- External Speaker Jack
- Power On/Off Push Switch
- Front MIC Jack
- 5 Level Preset Squelch

Channel Features

- Channel Select
- Instant Channel Programming
- One touch Instant Channel recalling
- Triple/Dual Watch with Instant Channel
- Group Scan and Priority Channel Watch
- Open Scan
- Master Scan
- Scan Channel Memory On/Off separately with Open Scan, Group Scan
- Busy Channel Lock-out Function
- 38 Built-in CTCSS (Continuous Tone Coded Squelch System) codes
- 104 additional DCS (Digital Coded Squelch) codes that are user selectable

¹ Refer to p.51 - p.53 for channel information

² Available frequencies & channels are within 400-520MHz Band only in 12.5kHz steps. Police, Fire & Ambulance reception is unencrypted analogue.

³ AVS - Automatic Volume Stabilizer detects and manages incoming audio to comparable levels.

⁴ This feature applies to UH9080 only

Controls & Connectors

Base (Front & Rear)

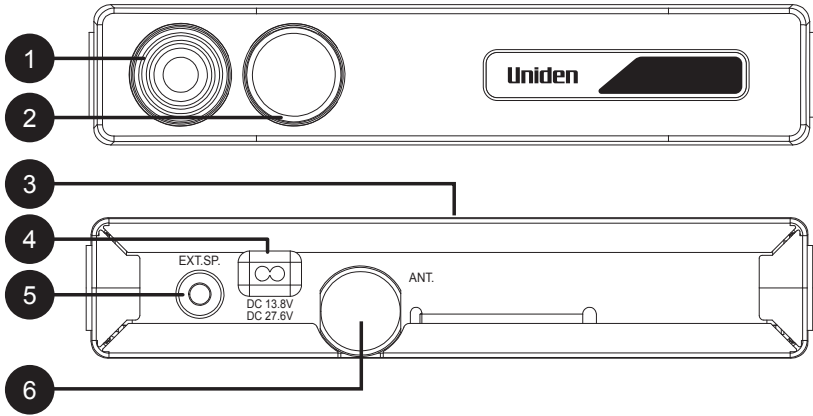

Remote LCD Speaker MIC RM-980 (FOR UH9080)

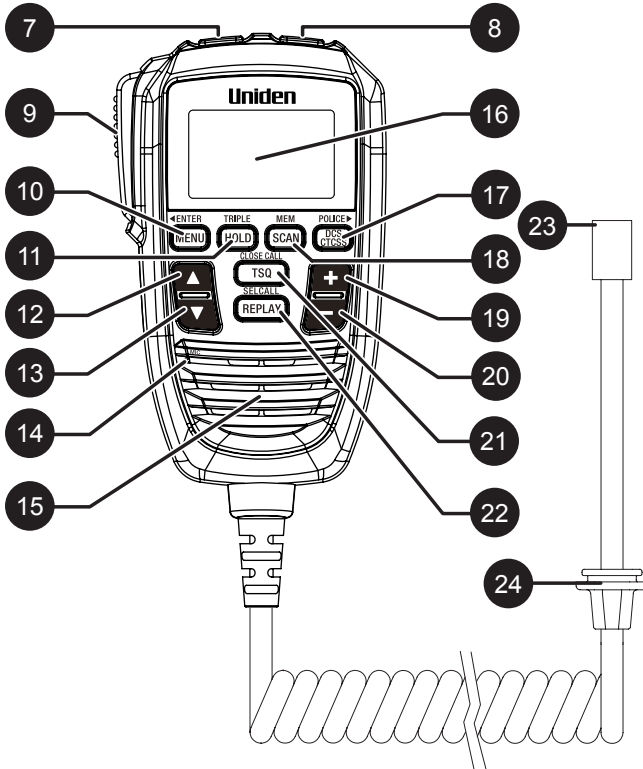

RM-960 (FOR UH9060)

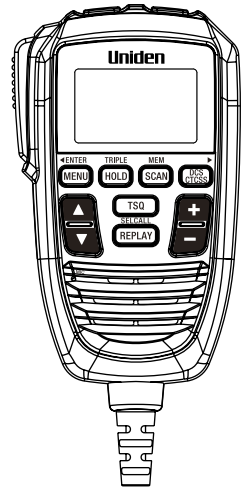





Controls & Connectors

Base (Front & Rear)

- 1 MIC Jack
- 2 MIC Jack
- 3 Main Speaker
- 4 Power Input Connection (13.8VDC or 27.6VDC)
- 5 **EXT SP** - External Speaker Jack
- 6 UHF Antenna Connection

Remote LCD Speaker MIC

- 7 **POWER** - Power Button
- 8 **SMART** - Multiple Function
- 9 **PTT** - Push To Talk Button
- 10 **MENU** - Menu Button/
/ENTER - Enter Button
◀ - Move selection left
- 11 **HOLD** - Hold Button
/TRIPLE - Triple Watch Button
- 12  - Channel Up Button/Select Up Button
- 13  - Channel Down Button/
Select Up Button
- 14 MICROPHONE
- 15 SPEAKER
- 16 Liquid Crystal Display (LCD)
- 17 **DCS/CTCSS** - DCS & CTCSS Button
/POLICE - Police/CB/Fire Button¹
▶ - Move selection right
- 18 **SCAN** - Scan Button
/MEM - Memory Button
- 19  - Volume Up Button
- 20  - Volume Down Button
- 21 **TSQ** - Tone Squelch Channel
/Close Call - Close Call Button¹
- 22 **REPLAY** - Replay Button
/SELCALL - Selective Calling Button
- 23 RJ45 type plug
- 24 Front MIC Jack Cover

¹ This feature applies to UH9080 only

Indicators

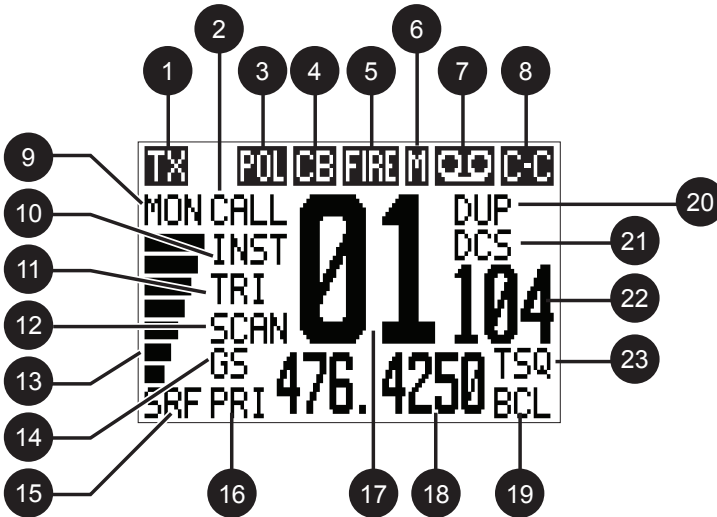

- 1 **TX/BUSY** - Transmit/Signal Receive
- 2 **CALL/CAL** - Call Tone/Sel Call
- 3 **POL** - Police Channel¹
- 4 **CB** - UHF CB + Ext RX Only Channel Bank¹
- 5 **FIRE** - Fire (+Ambulance) Channel Bank¹
- 6 **M** - Scan CH Memory
- 7  - Recording Mode
- 8 **C-C** - Close Call¹
- 9 **MON/SQT** - Monitor/Tight Squelch Level
- 10 **INST** - Instant Channel
- 11 **TRI/HOLD** - Triple Watch/Hold Mode
- 12 **SCAN** - Scanning
- 13 Signal Power Level
- 14 **GS** - Group Scan a
- 15 **SRF**- Signal Strength
- 16 **PRI** - Priority Watch
- 17 UHF-CB Channel
- 18 Channel Frequency /Alpha Tag display
- 19 **BCL** - Busy Channel Lockout
- 20 **DUP/LIST** - Duplex Channel/Close Call Lockout List¹
- 21 **DCS/CTCSS** - DCS/CTCSS selected
- 22 DCS/CTCSS Code Number /Extra RX Channel Indicator¹
- 23 **TSQ** - Tone Squelch

¹ This feature applies to UH9080 only

Included with your UH9060/UH9080 Transceiver



Remote LCD Speaker
Microphone
(RM-980/RM-960)

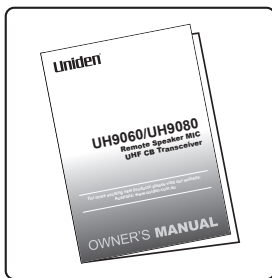

Owner's Manual

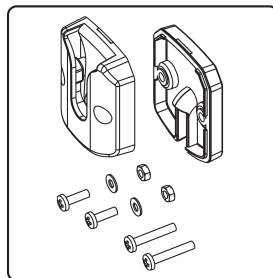

Microphone Hanger with
screws, washers

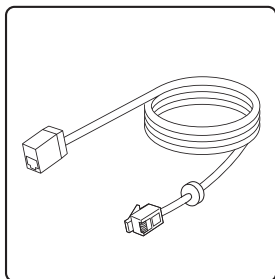

Extension Cable
(EC770)

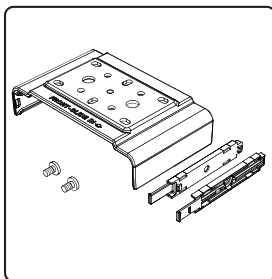

Slide Mount Bracket,
Guide Rails and
Screws

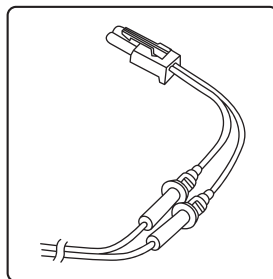

DC Power Cord
with fuse

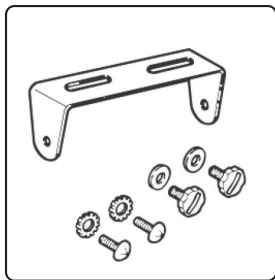

Mounting Bracket,
Mounting Screws,
Washer Stars And Screws

Optional Accessories

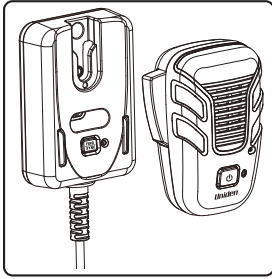

- UHF Antenna
- External Speaker

DECT Wireless
Speaker Microphone
(MK800W)

Visit the UH9060/UH9080 page on the website for more information on the availability of optional accessories:

www.uniden.com.au for Australia

Connecting the Microphone

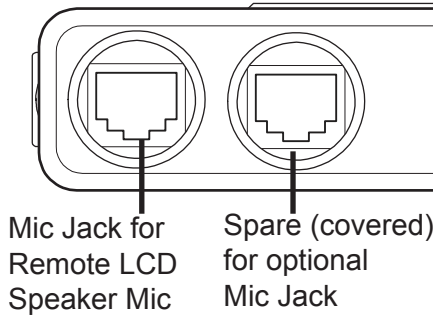

MIC Jack

Before connecting the Microphone Jack decide if you need to use the 2 metre Extension Cable - simply connect the MIC plug into the jack end of the Extension Cable

Push the MIC plug or Extension Cable plug into the MIC jack of the radio until the connection locks into place. Gently tug the MIC or Extension Cable cord to test that the connection is locked. Use the rubber cover which is on the cord to seal the MIC jack entry from dust.

Disconnecting the MIC from the MIC Jack

Pull back the rubber cover and move it down along the cord. Using the flat blade of a screwdriver or similar object carefully push the lock tab of the MIC plug towards the MIC cord and at the same time tug on the MIC cord to draw back the MIC plug.

Slide Mount Bracket

How to attach Slide Mount Bracket?

When you unpack the box, ensure that you have the slide mount bracket, guide rails and the screws.

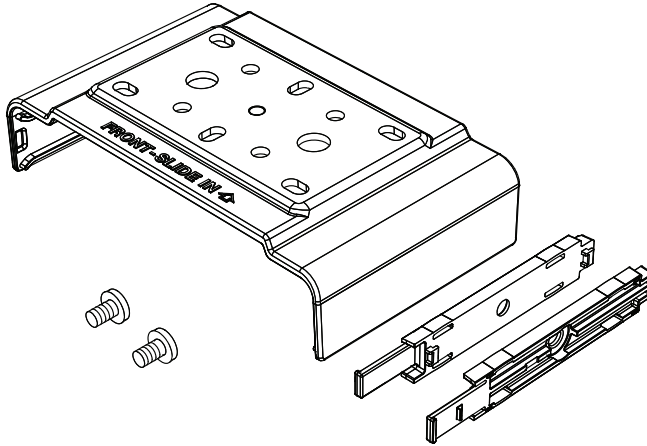

Align the guide rails along the side of the base and insert them into the slots provided. Then use the screws to lock them securely in position.

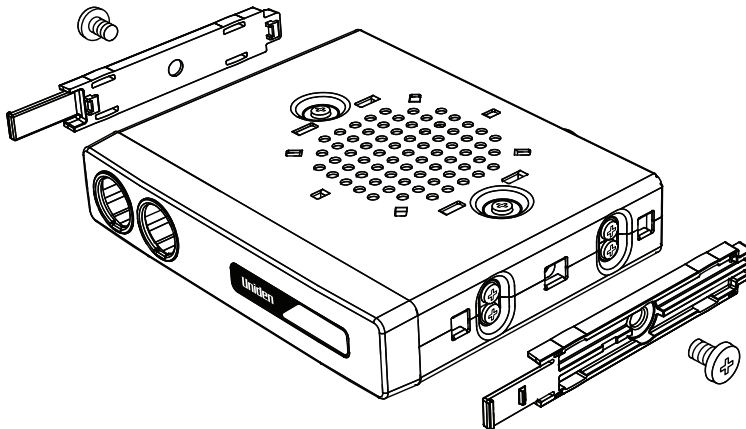

Slide Mount Bracket

Slide the bracket along the guide rails to attach the bracket to the unit.

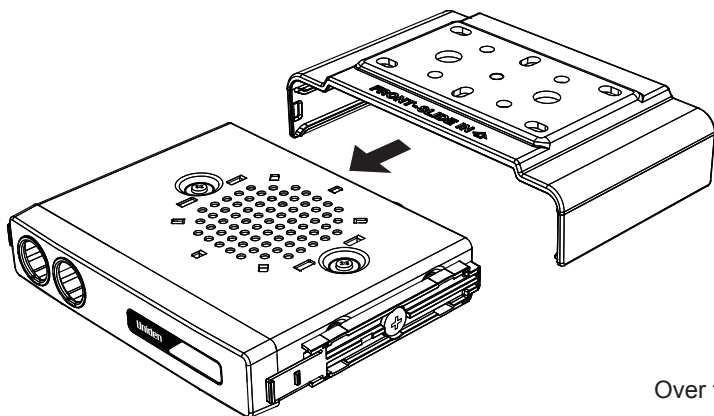

Over the BASE unit

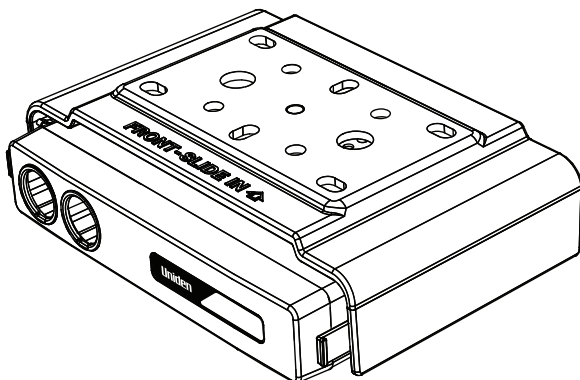

Under the BASE unit

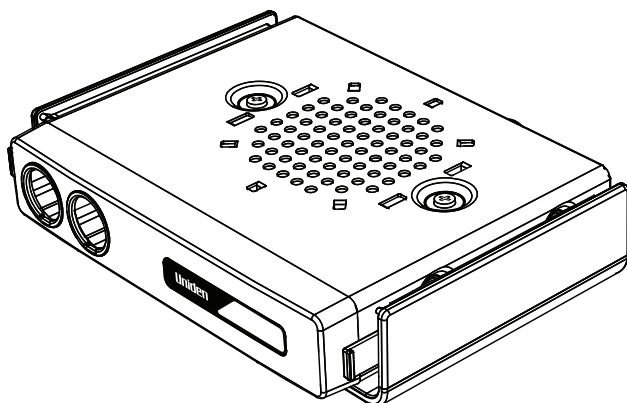

Mounting the MIC Hanger

The Microphone Hanger comes in two parts. How and where you mount the MIC hanger will determine which parts to use.

Conventional Mounting with Screws

Use the front part of the MIC Hanger only.

Locate a suitable mounting position and mark and drill two 3mm holes.

Fix the MIC Hanger into place with screws.

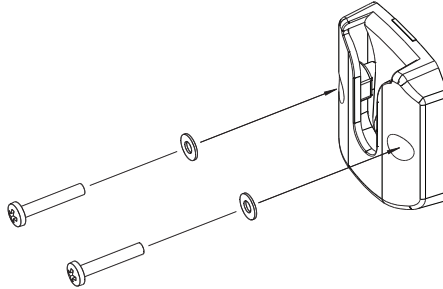

Conventional Mounting with Double Sided Tape (not supplied)

High quality Double-Sided tape can be found at good retail stores.

Secure the front and back pieces of the MIC Hanger using the supplied binding screws.

Locate a suitable mounting position.

Apply high quality Double-Sided tape onto the flat area of the MIC Hanger back piece and then press firmly to the mounting position.

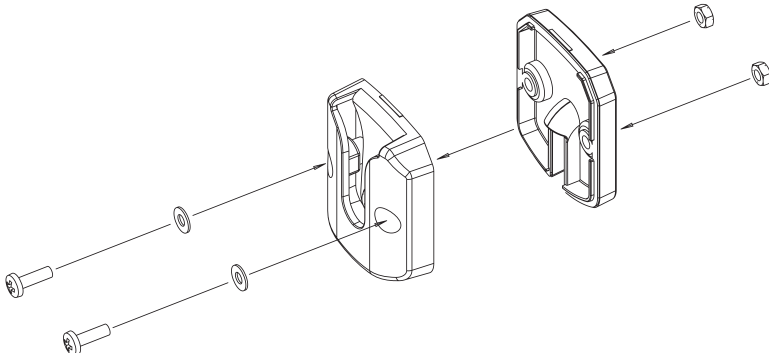

Mounting the MIC Hanger

MIC Hanger mounted over MIC Cable



The curly cord of the Remote LCD Speaker MIC can extend up to 1.5m. For practical installation of the MIC Hanger mounted over MIC Cable use this method with the Extension Cable.

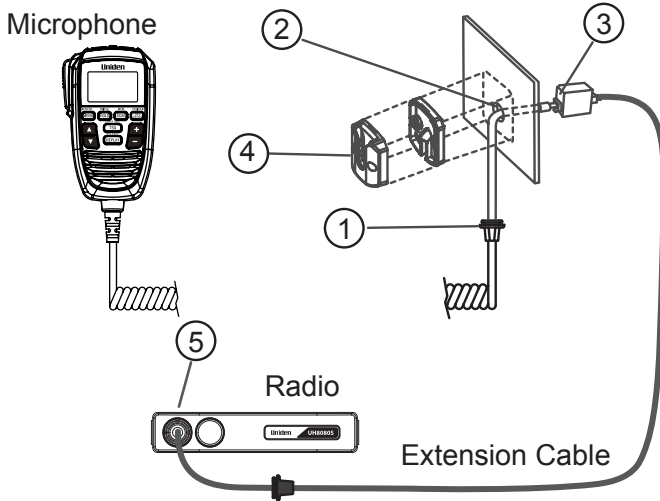

The plug of the extension cable connects to the Radio. The socket end of the extension cable connects with the microphone plug.

1. The rubber collar (dust cover) on the microphone cable is not required and can be cut away or pushed out of the way along the cable.
2. Drill a 13mm hole at the MIC hanger location.
3. Thread the microphone plug through the hole and connect with the extension cable.
4. Mount the MIC Hanger over the hole and cable.
5. At the Radio: Connect the extension cable plug to the MIC Jack. Fit the rubber bushing over the MIC jack.

Operation

Turning on the Power

Press and hold [POWER].

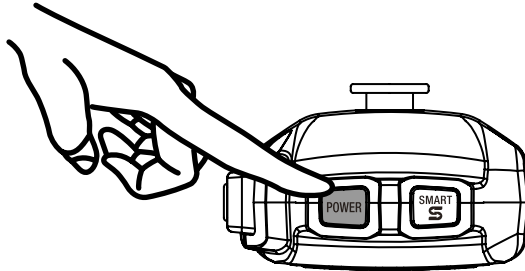

Low-Voltage/High-Voltage Alert

The UH9060/UH9080 can operate on 12VDC (13.8V) or 24VDC (27.6V) power supply, with the range between 10.2VDC to 28.8VDC.



NOTE

If the power supply voltage exceeds 30VDC, an alert tone sounds and **HI DC** flashes for 5 seconds. The power source must not exceed 32VDC otherwise permanent damage may occur to your radio, which may not be covered by the manufacturer's warranty.

If the input voltage falls below 10VDC, **LO DC** flashes for 5 seconds. The power turns off automatically if voltage falls below 9.0VDC.

Switch your UH9060/UH9080 OFF and disconnect it from the power source, before locating the cause of the power supply problem.



Operation

Setting the Auto Squelch Level

The Auto Squelch feature has 5 preset squelch levels:

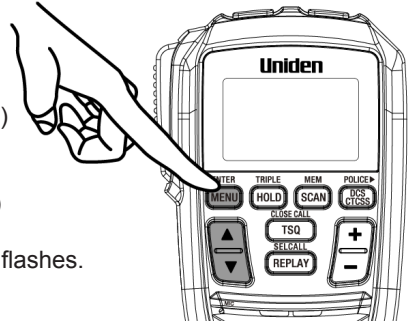
- SQL-0** - Squelch open
- SQL-1** - maximum sensitivity (minimum squelch)
- SQL-2** - moderate sensitivity
- SQL-3** - medium sensitivity
- SQL-4** - minimum sensitivity (max/tight squelch)



1. Press **[MENU]** one time. The squelch setting flashes.
2. Press  /  to change the setting.



NOTE

- If SQL-0 (squelch open) is selected then MON (monitor) icon flashes.
- If SQL-4 (tight squelch) is selected then SQT icon flashes.
- Selecting tight squelch mode may prevent the reception of weak signals.
- High noise areas may still break the squelch.

3. Press and hold **[MENU]** to save and exit from menu mode.

Smart-Key Function

The smart key **[S]** provides one touch access to one of these functions; Instant Channel, Call Tone or Equalizer.

Press and hold **[S]** to change the **SMART** key function between the three options.

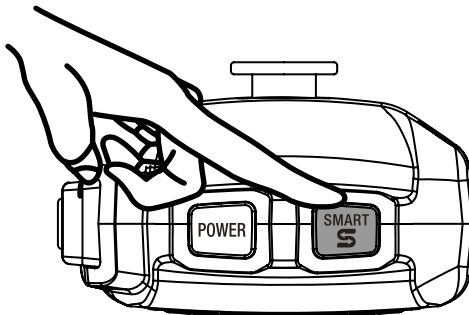

Operation

Voice Enhancer (EQL) Setting

Choose from 4 different receive audio level settings to provide a natural Voice Enhancer for super clarity and performance.

Press **[S]**, when in **SMART** key EQL mode, to change the setting between;

OFF : Normal - Standard of FLAT.

L1 : Bass - Enhancing the low frequency, the sound quality becomes mild and easy to listening, not causing fatigue.

L2 : Midrange - Enhancing midrange frequency, the sound quality becomes clear.

L3 : High - Enhancing the high frequency, the sound quality becomes sharp.

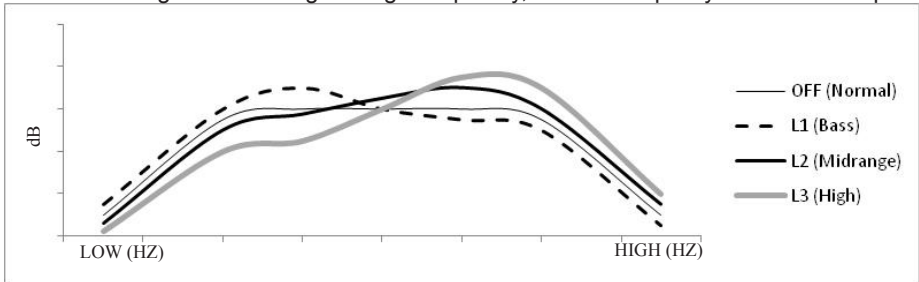

Programming the Instant Priority Channel-1

1. Press **[MENU]** four times. P-CH1 and current channel setting flashes.
2. Press **▲**/**▼** on the microphone to select the desired channel.
3. Press and hold **[MENU]** to save and exit.

Programming the Instant Priority Channel-2

1. Press **[MENU]** five times. P-CH2 and current channel setting flashes.
2. Press **▲**/**▼** on the microphone to select the desired channel.
3. Press and hold **[MENU]** to save and exit.

Recalling the Instant Channel

Press **[S]** when Smart Key is set to Instant Channel function.

Operation

Selecting a Channel

Press / to select the desired channel.

Channel Banks - Using the POLICE Button (Only for UH9080)

The UH9080 has three banks (groups) of channels to select from;

- CB** UHF CB + User programmable RX channels¹
- POL** Pre-programmed Police frequencies²
- FIRE** Pre-programmed Fire & Ambulance frequencies²

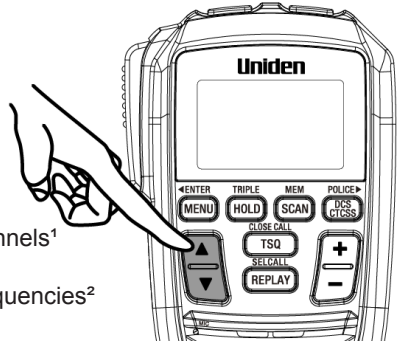

When the **CB** icon is showing the 80 UHF-CB and any user programmed RX channels will be available for selection or scanning. The 80 UHF-CB channels are numbered 01-80. The user programmable RX channels are numbered 81-180 and only show, in the DCS/CTCSS code area, when programmed.

When the **POL** icon is showing then pre-programmed police frequencies will be available. When the **FIRE** icon is showing then pre-programmed fire & ambulance frequencies will be available. The police, fire & ambulance frequencies do not have channel numbers, instead **PO** appears in the channel display for a police frequency and **FI** appears for a fire or ambulance frequency.

1. Press and hold [**POLICE**] to select the desired channel bank(s) combination.
The channel banks can be selected as follows;

----	CB	----
POL	----	----
----	----	FIRE
POL	----	FIRE
POL	CB	----
----	CB	FIRE
POL	CB	FIRE



¹ Available frequencies & channels are within 400-520MHz Band only in 12.5kHz steps.

² Police, Fire & Ambulance reception is unencrypted analogue.

For your reference a list of the available channels, corresponding frequencies and guidelines for their use is printed on p.51 - p.53. For Australia, Channels 05 and 35 are reserved for Emergency Calls.

Operation

Triple Watch

Triple watch will continuously monitor the two Instant Channel and the current channel for activity (see Programming the Instant Priority Channel-1/Channel-2, p.17)
Press and hold [TRIPLE] to switch Triple watch On/Off.

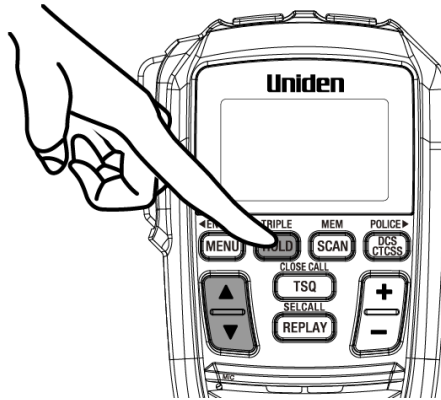

NOTE

- Every 1.5 seconds the Instant channel is monitored for 40msec.
- Triple watch function stops temporarily when receiving a signal.
- Triple watch function is invalid in Scan mode.

Transmitting

The UH9060/UH9080 transmits only on UHF-CB Channels.



NOTE

For your reference a list of the available channels, corresponding frequencies and guidelines for their use and selection is printed on p.51 - p.53. For Australia, Channels 05 and 35 are reserved for Emergency Calls.

Select the desired channel. Press **[PTT]** on the side of the Remote LCD Speaker MIC and speak normally into the microphone. Hold it approx. 7cm from your mouth. Release **[PTT]** to end the transmission and listen for a reply.

Operation

CTCSS (Continuous Tone Coded Squelch System)

Use the CTCSS or DCS privacy codes to talk to UHF-CB users, who are using the same code, without hearing other users on the same channel.

When a CTCSS or DCS tone is set for a UHF-CB channel, the CTCSS or DCS tone is displayed in the DCS/CTCSS code area. For channels with the setting of CTCSS OFF, there will be no display in the DCS/CTCSS code area.



CTCSS and DCS is not available on CH 05 and CH 35. For your reference a list of the available channels, corresponding frequencies and guidelines for their use and selection is printed on p.51 - p.53 For Australia, Channels 05 and 35 are reserved for Emergency Calls.

Press to select the desired channel to use CTCSS.

Press **[DCS/CTCSS]**.

CTCSS icon flashes.

Press to select the desired CTCSS code 01 - 38.

Press **[DCS/CTCSS]** once to store the new setting.

To turn off CTCSS (or DCS) select the OFF code during setting.

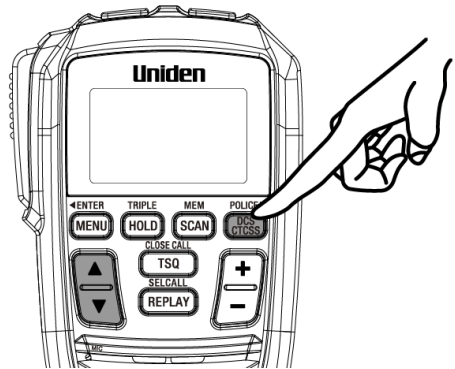

DCS (Digital Coded Squelch)

DCS is a digital extension of CTCSS. It provides 104 extra, digitally coded, squelch codes that follow after the 38 CTCSS codes. CTCSS 1-38, followed by DCS 1-104.

Follow the steps for setting a CTCSS code. Press until the DCS codes appear.

Press **[DCS/CTCSS]** to set. The DCS icon and code will display.

Operation

Call Tone

Call Tone

The radio is equipped with 10 selectable call tones that will be transmitted when [S] is press and Smart key is set to Call Tone function.

1. Press **[MENU]** eight times. CALLTONE setting flashes.
2. Press **▲**/**▼** on the microphone to change the selection. The 10 call tones are CALLTONE 1 to CALLTONE 10.
3. Press and hold **[MENU]** to save & exit from the menu mode.

Using Repeater Channels

UHF CB repeaters are used to retransmit or relay your signal. Repeaters will extend the range of your radio and overcome the shielding effect caused by solid obstructions. In normal Simplex operation, your radio transmits on one particular frequency and receives on that same frequency.

If there is a barrier that partially blocks your transmitted signal, the probability of another radio receiving the signal is very slim. Hills, tall buildings, metallic structures,...etc tend to act as a screen between radios.

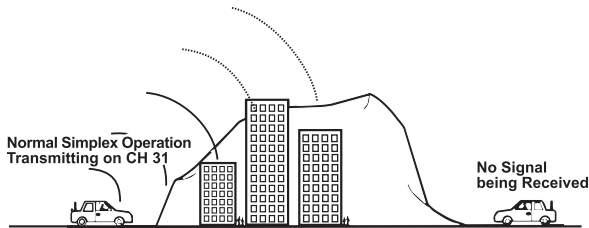

Standard Operation without the aid of a Repeater station.

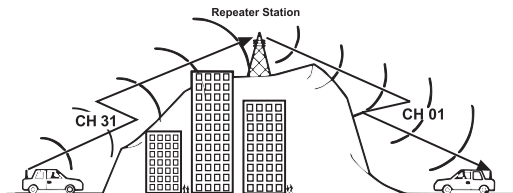

Operation with the aid of a Repeater Station (Duplex).

The signal coming from your radio is received by the Repeater Station and the re-transmitted at the same time on another channel. This operation is called "Duplexing".

Operation

For example,

CH01 on Duplex Mode will Receive on CH01 but Transmit on CH31

CH02 on Duplex Mode will Receive on CH02 but Transmit on CH32 etc...

If you transmit on CH01 Duplex mode, you are actually transmitting on CH31 the repeater station down-converts your signal and retransmits on CH01.

Operating the UHF CB Radio in Duplex Mode

For this example we are adopting CH01 as the channel being used in your area for repeater use.

1. Press **[MENU]** 2 times. The duplex setting flashes.
2. Press **▲**/**▼** to change the setting between ON or OFF (standard channel numbering).
3. Press and hold **[MENU]** to save & exit from the menu mode.

DUP icon displays when a selected channel is set to Duplex mode.

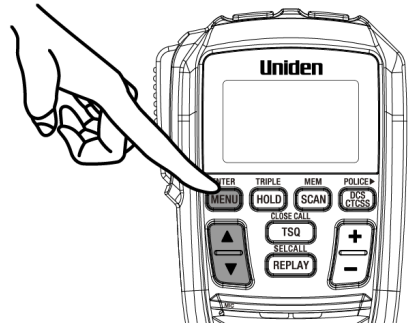

NOTE

- Only channels 01 - 08, and channels 41 - 48 are available for Duplex.
- Check with your local Retailer for information on available repeaters.
- If a button is not pressed within 10 seconds the UHF CB Radio will automatically exit the Menu Mode.

Operation

Scanning

The UH9060/UH9080's Scanning feature allows you to search for active channels automatically.

There are 3 scanning modes;

Open Scan (OS),

Group Scan (GS) and

Master Scan (M.SCN) (a special case of Group Scan).

During SCAN the UH9060/UH9080 only checks channels or frequencies that are in the SCAN Memory, which are indicated by the M (memory) icon. The UH9060/UH9080 maintains two SCAN Memories; one for Open Scan (OS) mode and the other for Group Scan (GS) mode, to give you flexibility and allow you to use the radio more effectively.



Group Scan and Master Scan modes share the same SCAN Memory.

Furthermore, any combination of the three channel groups can be scanned by pressing and holding **[POLICE]** during scan (except Master Scan) to select the desired channel groups.

1. Press **[SCAN]** to start Scanning.

2. The SCAN icon appears.

3. The scan direction can be changed at any time by pressing /.

4. Press **[SCAN]** to stop Scanning.

Add/Remove Channels from SCAN Memory

Select OS/GS Scanning Mode. Select the channel you want to store.

Press and hold **[MEM]**. MEM icon appears and two beep tones sound.

To remove the channel from SCAN memory, press and hold **[MEM]** once more.

The MEM icon disappears.

MASTER SCAN Mode

MASTER SCAN is the default scan mode and is enabled to allow continual communication across congested channels.

Master Scan scans channels stored into GS Memory and only opens the squelch for signals with the correct subcode (CTCSS or DCS tone).

To achieve this, all radios in your group must have the same channels in GS memory (group channels) and use the same Subcode (CTCSS or DCS tone).

By scanning only group channels, radios in the network will be able to detect and

Operation

receive group transmissions- continual communication without interruption. When transmitting in this mode, the radio switches to an unused group channel if it detects another signal with no code, or the wrong code, on the channel last used by the group. In this way, all group users will be able to have continual communication to or from other users.

CH09-CH20 are stored into GS Memory and CTCSS01 is set for MASTER SCAN Subcode by default. The GS memory can be changed, channel by channel, if desired - but for Master Scan to work effectively each radio in the group must have the same channels in its GS memory.

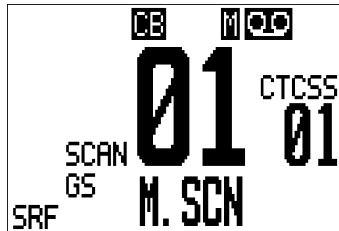

To add/remove channels from GS SCAN Memory, refer the section above.



NOTE

RX only Channels (CH22, CH23, CH61, CH62 and CH63), Emergency Channels (CH05, CH35), User Programmable RX Channels (CH81 to CH180) and Police or Fire (& Ambulance) channels group will not be included in MASTER SCAN Mode even though stored into GS Memory Also channels for which Duplex Setting are On will be skipped in MASTER SCAN Mode.

To select MASTER SCAN Mode:



1. Press **[MENU]** six times. The SCAN setting flashes.
2. Press / to change the setting to MS.

MS: Master Scan is ON with the current GS channel memory. Open/Group Scan is disabled.

- P1: Master Scan is ON with loading CH09-20 in GS.
P2: Master Scan is ON with loading CH21-30, 39, 40 in GS.
P3: Master Scan is ON with loading CH49-60 in GS.
P4: Master Scan is ON with loading CH61-70, 79, 80 in GS.

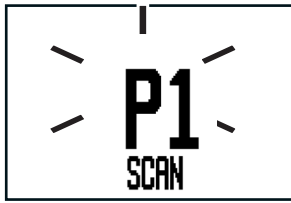
Operation



3. Press **[MENU]** one more time.
4. Press / to select the desired Subcode (CTCSS or DCS).

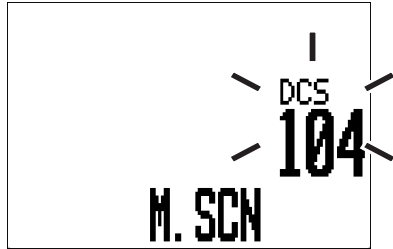
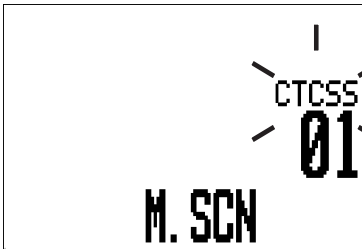

5. Press and hold the **[MENU]** to save and exit from the Menu Mode.



If a button is not pressed within 10 seconds the UHF CB Radio will automatically exit the Menu Mode.



Open Scan (OS) Mode

All UHF-CB, user-programmed extra RX channels, Police and Fire & Ambulance frequencies have been added to the OS SCAN Memory for convenience. To add/remove channels from OS SCAN Memory, refer to p.23.

Allows continuous scanning of all selected channels. If an active channel is found, scanning will stop on that channel. If the received signal ceases, the unit will wait 3 seconds for the signal to return, otherwise scanning resumes.

After transmission in scan mode, the unit will wait 20 seconds for the signal to return, otherwise scanning resumes.

To select OS Scan Mode:

1. Press **[MENU]** six times.
The SCAN setting flashes.
2. Press / to change the setting to OS.
3. Press and hold **[MENU]** to save and exit from the Menu mode.

Operation



If SCAN is deactivated while on an active channel, the UH9060/UH9080 will stay on that active channel. If no channels are active, the UH9060/UH9080 will reinstate the starting channel.



OS Mode is indicated by the absence of the GS icon.

Group Scan (GS) Mode

GS Mode has CH09 to CH20 in the SCAN Memory by default. Channels must be stored to the GS SCAN Memory before group scan can start. To add/remove channels from GS SCAN Memory, refer to p.23.



Includes the accessory feature Priority Watch which allows you to monitor the Instant Priority Channel while scanning (see p.17 for setting Instant Priority Channel and p.27 to turn on Priority Watch).

GS Scanning checks the Instant Priority Channel for activity regularly when Priority Watch is ON.

If the Priority Channel becomes active the radio will stay on that channel for as long as the signal is present. If the received signal ceases, Priority Scanning continues after 3 seconds.

If scanning stops on a channel which is not a Priority Channel, UHF CB Radio will continue monitoring the Priority Channel for activity while listening to the active one.

To select GS Scan Mode:

1. Press **[MENU]** six times.
The SCAN setting flashes.
2. Press  /  to change the setting to GS.
3. Press and hold **[MENU]** to save & exit from the menu mode.



If a button is not pressed within 10 seconds the UHF CB Radio will automatically exit the Menu Mode.

Operation

Priority Watch

To switch Priority Watch On/Off;

1. Press **[MENU]** three times.
The Priority Watch setting flashes.
2. Press **▲**/**▼** to change the setting between ON or OFF.
3. Press and hold **[MENU]** to save & exit from the menu mode.

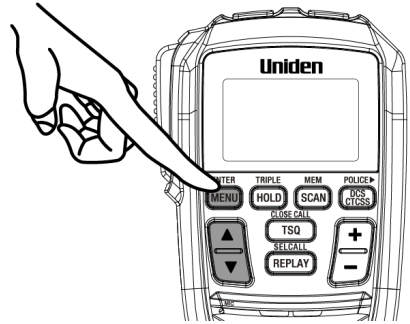

If SCAN is deactivated while it is tuned to an active channel, the UH9060/UH9080 will stay on that active channel. If none of the channels are active, the UH9060/UH9080 will reinstate the scan start channel.



If OS/GS Scanning is initiated when there are no channels programmed in OS/GS memory, an error tone will be heard and scanning will not start (see Add/Remove Channels from SCAN Memory, p.23).



If a button is not pressed within 10 seconds the UH9060/UH9080 will automatically exit the Menu Mode.

Operation

Busy Channel Lockout

If the channel is already in use, you can prevent the UHF CB Radio from transmitting. This is particularly important when using CTCSS/DCS.

1. Press **[MENU]** nine times.
The BCL setting flashes.
2. Press **▲**/**▼** to change the setting between ON or OFF.
3. Press and hold **[MENU]** to save & exit from the menu mode.

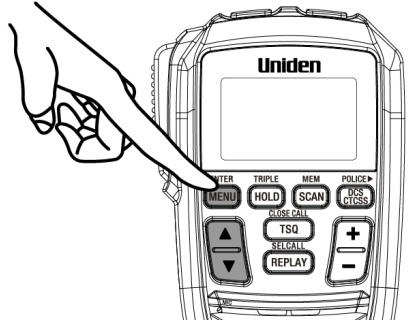

If a button is not pressed within 10 seconds the UH9060/UH9080 will automatically exit the Menu Mode.

Roger Beep

1. Press **[MENU]** ten times.
The roger beep (**ROGER**) setting flashes.
2. Press **▲**/**▼** to change the setting between ON or OFF.
3. Press and hold **[MENU]** to save & exit from the menu mode.

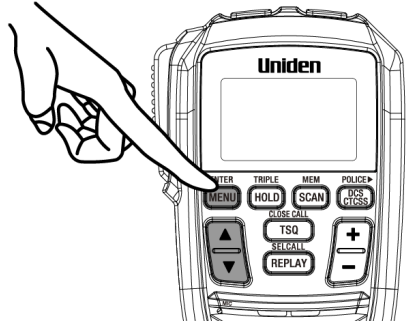

If a button is not pressed within 10 seconds the UH9060/UH9080 will automatically exit the Menu Mode.

Operation

Key Beep On/Off

1. Press **[MENU]** eleven times.
The key beep (**BEEP**) setting flashes.
2. Press **▲**/**▼** to change the setting between OFF, 1, 2, 3... 7.
3. Press and hold **[MENU]** to save & exit from the menu mode.

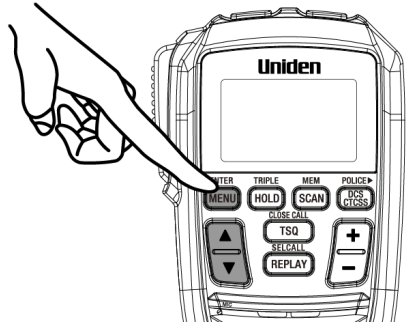

If a button is not pressed within 10 seconds the UHF CB Radio will automatically exit the Menu Mode.

Alpha Tag

The SELCALL IDs and Extra Receive Channels have the option of displaying a name (Alpha Tag) instead of the ID or frequency. Set Alpha Tag to ON to display the name if it has been programmed.

1. Press **[MENU]** twelve times.
The Alpha Tag (**ALPHA**) setting flashes.
2. Press **▲**/**▼** to change the setting between ON or OFF.
3. Press and hold **[MENU]** to save & exit from the menu mode.

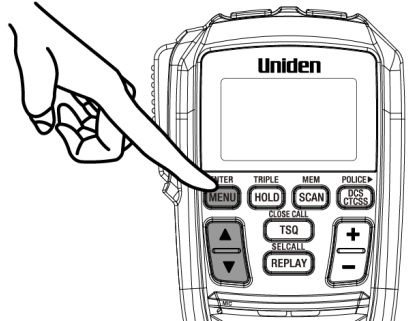

If a button is not pressed & within 10 seconds the UHF CB Radio will automatically exit the Menu Mode.



Operation

Volume Sync

Use this to set which speaker(s) the Volume / buttons control.

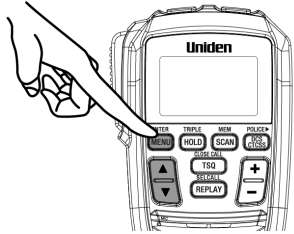
Set **01** to control the speaker volume of the Base unit only.
Set **02** to control the speaker volume of Remote MIC only.
Set **03** to control the speaker volume of both Base unit and Remote MIC - both volume levels will be synchronised.



1. Press **[MENU]** thirteen times.
The Volume Sync setting flashes.
2. Press / to change the setting between 01, 02 or 03.
3. Press and hold **[MENU]** to save & exit from the menu mode.





- The speaker that is not selected for control maintains its previous volume setting.
- When an optional External Speaker is connected to the Ext.Sp. jack of the base, it substitutes for the Base unit speaker which becomes muted. Therefore 01 MAIN & 03 SYNC control the External Speaker in place of the base unit speaker.



If a button is not pressed within 10 seconds the UHF CB Radio will automatically exit the Menu Mode.

Backlight Colour

1. Press **[MENU]** fourteen times.
The current Backlight colour (**CLEAR, BLUE, RED, PURPLE, GREEN, CYAN or YELLOW**) setting flashes.
2. Press / to change to the desired colour setting.
3. Press and hold **[MENU]** to save & exit from the menu mode

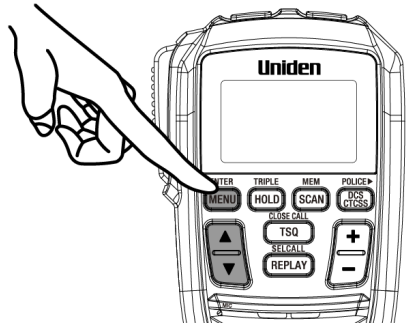

If a button is not pressed within 10 seconds the UHF CB Radio will automatically exit the Menu Mode.

Operation

Backlight Level

1. Press **[MENU]** fifteen times.
The Backlight level (**LIGHT**) setting flashes.
2. Press **▲**/**▼** to change the setting between OFF, 01, 02 and 03.
3. Press and hold **[MENU]** to save & exit from the menu mode.

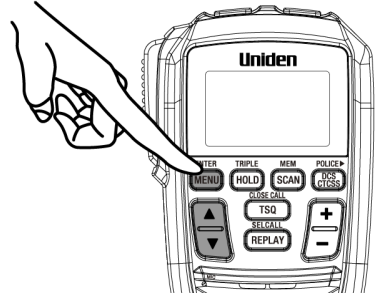

LCD Contrast

1. Press **[MENU]** sixteen times. The LCD Contrast setting flashes.
2. Press **▲**/**▼** to change the setting between 01 (low contrast) to 10 (high contrast).
3. Press and hold **[MENU]** to save & exit from the menu mode.

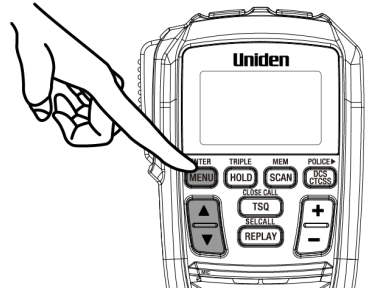

Scramble On/Off (Only for UH9080)

Scramble enables private communications by scrambling the voice signal. This prevents users without descrambler equipment or a compatible unit understanding the conversation. Select desired channel.

1. Press **[MENU]** eighteen times. The Scramble setting flashes.
2. Press **▲**/**▼** to change the setting between OFF, 1 (Scramble-1), 2 (Scramble-2).
3. Press and hold **[MENU]** to save & exit from the menu mode.



NOTE

For safety purposes Scramble is invalid on channel 5, 11, 22, 23 and 35.



NOTE

If a button is not pressed within 10 seconds the UHF CB Radio will automatically exit the Menu Mode.

Operation - Special Features

Instant Replay

The Instant Replay feature automatically records up to 1 minute of received signal(s) which can be instantly replayed (through the speaker) by pressing **[REPLAY]**.

Instant Replay automatically records receive signal(s) in the following modes;

- CB & Extra RX channel, Police and Fire (& Ambulance) channel mode
- Scan Mode
- Close Call RF Capture mode



Instant Replay does not record when in monitor mode (SQT-0 setting in normal channel mode).

Press **[REPLAY]** at anytime to;

1. Playback the most recent received signal.
OR
2. Playback the most recent recorded signal in the replay buffer (if Instant Replay automatic receive record was turned Off, see Turning Instant Replay On/Off below).

During playback the display shows REPLAY and the number of the currently playing recording.

After the most recent received signal has been played back, a long confirmation tone sounds and the radio returns to the previous mode.



During playback older recordings can be accessed by pressing / to skip forward/back between recordings stored within the 1 minute buffer. The record number indicates which discrete recording is currently being replayed.



- Received signals shorter than 500ms are not recorded.
- Automatic recording of receive signal(s) is temporarily suspended during Instant Replay playback.
- Older recordings are automatically overwritten when new recordings are stored.
- Most received communications are short and the 1 minute buffer may contain several recordings.
- Transmissions (TX) are not recorded.

Turning Instant Replay On/Off

Instant Replay is ON by default. The  icon displays to indicate Instant Replay automatic record is On.

1. Press **[MENU]** seventeen times. The Instant Replay (**RECORD**) setting flashes.
2. Press / to change the setting between ON or OFF.
3. Press and hold **[MENU]** to save & exit from the menu mode.

Operation - Special Features

100 User Programmable RX Channels (Only for UH9080)











The UH9080 has 100 receive only channels (CH81 to CH180) which can be programmed with frequencies ranging from 400-520MHz (in 12.5kHz steps). The extra RX channels only appear, as part of the CB channel bank, when a frequency has been programmed to a channel. There are three ways to programme RX channels;

1. If you know the frequency you may manually programme it to a channel.
2. Store a Police or Fire (& Ambulance) frequency to a channel.
3. Use the Close Call RF Capture feature to find a nearby strong signal & store this frequency to a channel.

Furthermore, the RX channels can be Alpha Tagged (given a name) if desired.

Manually Programme a RX Channel (Only for UH9080)

In CB channel mode (UHF CB channel);





1. Press & hold **[MENU]**. The lowest available empty RX channel will flash.
2. Press / if you wish to select another RX channel.
3. Press **[REPLAY]** to begin the frequency edit. The MHz digit range flashes.
Use  or  to shift between MHz range (between 400-520MHz) & kHz range (in 12.5kHz steps).
Press / to select the desired frequency within MHz & kHz ranges.
4. When desired frequency is entered press **[REPLAY]** to move to Alpha Tag selection. A cursor flashes in the 1st alpha position.
If you do not wish to name the channel then skip this step.
Press / to select the desired alpha character.
Use  or  to shift between cursor positions.
5. When finished press **[REPLAY]**. A long confirmation tone sounds to indicate the new channel is programmed.
The channel flashes to enable selection for programming of next channel if desired.
6. Press and hold **[ENTER]** to exit programming mode.



Operation - Special Features





Search Extra Channel Range and Programme a RX Channel (Only for UH9080)

The UH9080 can search extra channel range (400MHz-520MHz) per 12.5KHz step. Then you can store they stay frequency to extra channel.

In CB channel mode (UHF CB channel)



1. Press & hold **[MENU]**. The lowest available empty RX channel will flash.
2. Press / if you wish to select another RX channel.
3. Press **[SCAN]** to start scanning. The scan direction can be changed at any time by pressing / on the microphone.

If an active frequency channel found, scanning will stop on that frequency. To skip, press / on the microphone to continue scanning.



4. When desired frequency is found, press **[REPLAY]** to move to Alpha Tag selection. A cursor flashes in the 1st alpha position. If you do not wish to name the channel then skip this step. Press / to select the desired alpha character. Use  or  to shift between cursor positions.
5. When finished press **[REPLAY]**. A long confirmation tone sounds to indicate the new channel is programmed. The channel flashes to enable selection for programming of next channel if desired.
6. Press and hold **[ENTER]** to exit programming mode.

Operation - Special Features

Store a Police or Fire frequency to a RX Channel (Only for UH9080)

Select the Police or Fire (& Ambulance) channels group by pressing and holding **[POLICE]**, and then select a desired frequency using /.



Or during SCAN, when scan stops on a Police or Fire (& Ambulance) frequency which you wish to store press **[HOLD]** to stay on that frequency.

1. Press and hold **[ENTER]**. The lowest available empty RX channel will appear, alternating with the selected Police and Fire (& Ambulance) frequency.
2. Change the RX channel using / if desired.
3. Press and hold **[ENTER]**. A confirmation tone sounds to indicate the new channel is programmed.
The RX channel number flashes.
4. If a name is desired press **[REPLAY]** twice to begin Alpha Tag edit (see manual programming above).
5. Press and hold **[ENTER]** to exit programming mode.

Store a frequency found using CLOSE CALL to a RX Channel (Only for UH9080)

Start Close Call RF Capture feature.

When an active frequency is found which you wish to store press **[HOLD]** to stay on that frequency.

1. Press and hold **[ENTER]**. The lowest available empty RX channel will appear, alternating with the found frequency.
2. Change the RX channel using / if desired.
3. Press and hold **[ENTER]**. A confirmation tone sounds to indicate the new channel is programmed.
The RX channel number flashes.
4. If a name is desired press **[REPLAY]** twice to begin Alpha Tag edit (see manual programming above).
5. Press and hold **[ENTER]** to exit programming mode.

Operation - Special Features

Close Call™ RF Capture (Only for UH9080)

The Close Call RF Capture feature sets the UH9080 so it detects and then displays the frequency of a nearby strong radio transmission. Close Call RF capture works great for finding frequencies at venues such as malls and sporting events.

Close Call RF Capture doesn't tune to a frequency to check for a transmission, instead it directly detects the presence of a strong, nearby signal and instantly tunes to the source's frequency. The UH9080 only tries to find Close Call transmissions from 400-520 MHz.



- Close Call RF capture works well for locating the source of strong local transmissions such as mobile and handheld two-way radios in areas with no other strong transmission sources. However, if you are in an area with many transmission sources (such as pager radio transmitters, multi-use radio towers, traffic control devices, etc.), Close Call RF capture might not find the transmission you are searching for, or it might find a transmission other than the one you are searching for.
- Close Call works better with some types of transmissions than others. It might not correctly display frequency information for transmitters using a highly directive antenna (such as an amateur radio beam antenna), if there are many transmitters operating at the same time in the same area, or if the transmitter is a broadcast television station.

Operation - Special Features

Using Close Call

To start or stop Close Call RF Capture:

1. Press and hold **[CLOSE CALL]**. The C-C icon appears and C.CALL is displayed when Close Call RF Capture mode.



When a signal is found a confirmation chirp is sounded and CC FOUND flashes on the display. Press any key (except CLOSE CALL key) when CC FOUND is displayed to show the frequency. The signal strength is also displayed with CC FOUND display.

Lockout an Undesired Frequency

If the signal frequency is undesired (for instance it is a data channel) then the frequency can be added to the lockout list and ignored in future.

1. First press **[HOLD]** to stay on that frequency.
2. And then press and hold **[HOLD]** to lockout that frequency and resume Close Call RF Capture mode.

Unlock a Locked out frequency

1. The locked out frequencies can be reviewed by pressing **[MENU]**. LO displays and the lowest frequency in the lockout list flashes.
2. Press / to view other frequencies in the list.
3. Press and hold **[HOLD]** to unlock the currently displayed frequency. Two beeps sound.
4. Press **[MENU]** to resume Close Call RF Capture mode.



- Close Call RF Capture feature is separate to and cannot be operated at the same time as SCAN or normal receive mode.

Operation - Special Features

Selective Calling

Selective Calling (Selcall) is a special Sequential Tone Squelch System that allows the user to receive/transmit calls selectively from/to an individual or group, on a shared busy channel. Therefore Selcall is a group feature used by groups with similarly set up radios.

The UH9060/UH9080 has a Selective Calling system. Exceptional features, like 10 Selcall ID Memories, Receiver Quieting, Tone Squelch Scanning, Tone and Group Calling make the UH9060/UH9080 superior to other transceivers in its class.

Receiver Quieting (Tone Squelch)

When activated on individual UHF-CB channels (except for emergency CH05 and CH35), it automatically mutes the receiver audio circuit of the radio. It will stay in this Quiet mode as long as the Selcall tone code (Selcall ID) required to open the muting circuit is not received.

Call Alarm

When a received code matches to your Selcall ID, an alarm (CA Alert) will be emitted informing you that a caller is on the channel.

Tone Squelch Scanning

Scans only tone squelched Channels.

Tone Calling

Allows you to selectively call another radio. Up to 10 Selcall IDs can be stored for frequently called radios.

Group Calling Capability

Transmits Group Calls.

Operation - Special Features

Programming the Selcall ID

The radio Selcall ID is the ID other users will identify as being your radio. It is set in the Selcall settings menu as follows:

1. Switch Off the Power.
2. Press and hold **[POWER]** and **[MENU]**. The UH9060/UH9080 should turn on in the SELCALL Menu selection state (no tone will sound). Cd displays to indicate the Call ID setting (factory default ID is 00000).
3. Press **[SCAN]** to begin the Selcall ID edit. The 5th digit of the ID flashes.
4. Use ◀ or ▶ to shift between digits. A 6th digit (for 6 tone Selcall) is available and indicated by a ' _ '.
5. Press ▲/▼ to select the desired ID.
6. Press and hold **[ENTER]** to exit the setting mode.
7. Press and hold **[ENTER]** again to exit programming mode.
A long confirmation tone sounds.

Storing Selcall IDs of other users to the ID Memory

1. Press and hold **[SELCALL]**. The Selcall ID memory will open.
2. Press ▲/▼ to select the desired memory slot to edit.



- Up to 10 ID memories can be stored.
- If you expect to make calls to radios not stored in the ID memory then leave memory ID 1 blank for manual ID entry at the time of the call.

3. Press **[SCAN]** to begin the ID edit. The 5th digit of the ID flashes.
4. Use ◀ or ▶ to shift between digits. A 6th digit (for 6 tone Selcall) is available and indicated by a ' _ '.
5. Press ▲/▼ to select the desired ID.
6. When desired ID is entered press **[SCAN]** to move to Alpha Tag selection.
A cursor flashes in the 1st alpha position. The default alpha tag is blank - displays as No Name. If you do not wish to name the ID then skip to step 9.
7. Press ▲/▼ to select the desired alpha character.
8. Use ◀ or ▶ to shift between cursor positions.
9. When finished press **[SCAN]**. A confirmation tone sounds to indicate the ID is programmed. The memory number flashes to enable selection for programming of next memory if desired.
10. Press and hold **[ENTER]**, or wait for 10sec, to exit programming mode.

Operation - Special Features



Tone Calling (Making a Selcall Call)

Tone Calling allows you to selectively call other radios.





For convenience, the Selcall ID of the radio you are going to call should be in the Selcall ID memory (see Storing Selcall IDs of other users to the ID Memory p.39).

If not then the Selcall ID can be manually entered for this call.

To Call:

1. Select the channel that you and your group agreed to use for Selective Calling.
2. Press and hold **[SELCALL]** for 2 seconds.
A double beep tone will sound and the last stored ID or last transmitted ID will be displayed.
3. Use / to select the desired Selcall ID.

If the desired Selcall ID is not stored in the ID memory you can manually enter the ID as follows;

- a) Press **[SCAN]** to begin ID edit. The 5th digit of the ID flashes.
 - b) Use  or  to shift between digits. A 6th digit (for 6 tone Selcall) is available and indicated by a ' _ '.
 - c) Press / to select the desired ID.
4. Press **[SELCALL]** to transmit the Selcall.
CAL will display when transmitting the Selcall.

An acknowledge tone coming from the called radio will be received if you have successfully made contact. The acknowledge tone for the UH9060/UH9080 is a succession of three low tone beeps.

Receiver Quiet (TSQ) Mode



Puts the receiver in the QUIET mode (also known as the Tone Squelch (TSQ) mode) for the selected channel. When activated, the transceiver prevents any unwanted conversations in the channel from being heard unless the call is specifically directed to you and the Selcall ID required to open the QUIET condition has been received.



Under this condition, **PTT** is temporarily disabled. If you wish to use the same Channel for normal communication, simply remove the channel from QUIET mode.

Operation - Special Features

To Activate/Deactivate Tone Squelch (TSQ) on a Channel

1. Use  /  to select the channel you want to put in or take out of 'QUIET' mode.
2. Press **[TSQ]**. Beep will sound and the TSQ icon appears on or disappears from the LCD display.

Receiving a Selcall

While in TSQ mode, when UH9060/UH9080 receives a code matching your Selcall ID, it will perform the following operations:

- a) Automatically responds to the caller by transmitting Acknowledge Tones.
- b) Informs you that a caller is on the Channel by emitting a CALL ALARM (Default Alarm Setting: four successive beeps in a regular interval for 10 seconds. Refer to p.46, 'Alarm Mode' for other alarm settings) and displays the CAL icon.
- c) Flashes the TSQ icon for about 20 seconds allowing you to use the PTT button. If you are not able to respond within the 20 second period, TSQ icon stops flashing and 'QUIET' mode resumes.



NOTE

The UH9060/UH9080 can decode a Selcall call even though not in 'QUIET' mode.

Operation - Special Features

Scanning Tone Squelched Channels

If you are using two or more Channels in the TSQ mode, you can monitor all of these Channels for selective calls by using the TSQ scanning feature.

To use this feature start the TSQ Scan by pressing **[TSQ]** during Open Scan, Group Scan or Master Scan.



Unlike Normal Scanning, TSQ scans and checks detected signals for Selcall information. If this information is not found, TSQ Scanning resumes.

When a call is received during TSQ Scanning, UH9060/UH9080 follows the same response as when receiving a call on a Tone Squelch Channel. It differs only in the following ways:

1. If the call is not answered within 20 seconds, TSQ Scanning resumes.

The CAL icon remains on the LCD display.

To look for the Channel where the CALL is received.

- a) Cancel TSQ Scanning by pressing **[SCAN]**.
- b) Using /, browse through the TSQ Channels. The CAL indicator marks the Channel where the Call is received.

2. When answered, TSQ Scanning is automatically deactivated. The Channel is removed from the QUIET Operating Mode.

To deactivate TSQ Scanning:

- a) Press **[TSQ]**.
The unit returns to Normal Scanning Mode.
- b) Press **[SCAN]**.
The whole scanning operation is cleared.
- c) When a Selcall is received, press **PTT**.



The chance of receiving and decoding Selcalls effectively during TSQ Scanning can be increased in many different ways. You can either decrease the number of channels to be scanned thus increasing the scanning speed – or – change some of the Selcall parameters (refer to 'Selcall Programming').

Operation - Special Features

Group Calling

The UH9060/UH9080 has the capability to respond to Group Calling and to transmit Group Calling Codes.

Group Calling allows you to call members of your group simultaneously. However, to do this, you need to follow a certain format (see below) when programming your TX Selcall ID.

Selcall ID Format

To call	Transmitter SELCALL ID
10 radios	[X] [X] [X] [X] [A]
100 radios	[X] [X] [X] [A] [A]
1000 radios	[X] [X] [A] [A] [A]
10000 radios	[X] [A] [A] [A] [A]

where: [X] is a common Selcall ID prefix of your group
- and - [A] is the CCIR Assigned Group Tone Code

Example:

If one group comprises 10 members with Selcall IDs the ID numbers could be as follows:

Group ID #	Individual ID#
[1] [2] [3] [4]	[0]
[1] [2] [3] [4]	[1]
[1] [2] [3] [4]	[2]
[1] [2] [3] [4]	[3]
to -	
[1] [2] [3] [4]	[9]

all in TSQ mode at CH20

If someone transmits ID 1234A on CH20, all of the above units will open their Tone Squelched Receiver.

Group Calls and ordinary Selcalls can be differentiated in the following manner:

Group Call - Low tone beeps
Ordinary Selcall - High tone beeps

Operation - Special Features

SELCALL Settings

Tone Period

Tone period is the duration of one tone in a Selcall ID sequence. The setting of this parameter depends on the type of application. On long distance communications, for example: where the signal strength of the transmitted information is greatly reduced and affected by noise, it is advisable to use a longer Tone Period. A long Tone Period gives the decoder more time and information to check and evaluate the code.



However, be sure that all the radios in your group use the same Tone Period setting. Otherwise you will not be able to selectively call one another.

The UH9060/UH9080 allows you to select which Tone Period is best for you. The three most commonly used tone settings (40,70 or 100 mSec) are available. With the freedom to change this parameter, you can easily adapt to the existing system in your group without the inconvenience of having the unit serviced by the dealer.

1. Switch Off the Power.
2. Press and hold **[POWER]** and **[MENU]**. The SELCALL Settings Menu will display (no tone will sound).
3. Press **[MENU]** repeatedly to select the Tone Period setting - which is indicated on the display as Pd.
4. Press **[SCAN]** to edit the setting. The current setting flashes.
5. Press **▲/▼** to select the desired tone period from 40ms, 70ms or 100ms.
6. Press **[SCAN]** to exit the setting.
7. Press and hold **[ENTER]**, to save and exit programming mode.



Lead-in Delay

Lead-in delay is a Selcall transmission parameter that 'wakes-up' and helps the receiver of the other radio to lock onto the incoming signal. Each time a Selcall ID is transmitted, the Lead-in Delay attaches itself to the beginning of the code sequence and causes the transmitter to be on for a longer period prior to the code transmission. This makes for a stronger communication link between the transmitter and the other receiver.

One major advantage to having the longer Lead-in Delay is when selectively calling another radio via a repeater station. A longer Lead-in Delay helps to stabilise both the communication link from your radio to the repeater station and from the repeater station to the other radio.



Operation - Special Features

Lead-in Delay Programming

1. Switch Off the Power.
2. Press and hold **[POWER]** and **[MENU]**. The SELCALL Settings Menu will display (no tone will sound).
3. Press **[MENU]** repeatedly to select the Lead-in Delay setting - which is indicated on the display as Ld.
4. Press **[SCAN]** to edit the setting. The current setting flashes.
5. Press  /  to select the desired Lead-in delay period from 500ms, 1000ms, 2000ms, 3000ms or 4000ms.
6. Press **[SCAN]** to exit the setting.
7. Press and hold **[ENTER]**, to save and exit programming mode.

Lead-in Tone

The Lead-in Tone, when programmed, 'rides' on the Lead-in Delay. Hence, when transmitting a Selcall ID, a continuous tone will be heard for the duration of the Lead-in Delay. The main purpose of the Lead-in Tone is to increase the probability of contact between your unit and another radio when TSQ Scanning.

1. Switch Off the Power.
2. Press and hold **[POWER]** and **[MENU]**. The SELCALL Settings Menu will display (no tone will sound).
3. Press **[MENU]** repeatedly to select the Lead-in Tone setting - which is indicated on the display as LT.
4. Press **[SCAN]** to edit the setting. The current setting flashes.
5. Press  /  to select the desired Lead-in Tone.



- If you want to remove the Lead-in Tone choose the space [_] Bar.

6. Press **[SCAN]** to exit the setting.
7. Press and hold **[ENTER]**, to save and exit programming mode.

Operation - Special Features

Alarm Mode

When a received code matches to your receiver Selcall ID the UH9060/UH9080 will respond based on the Call Alarm mode.

Call Alarm - Auto mode (Default)

- a) Transmit an Acknowledge tone to the Caller.
- b) Emit CALL Alarm for 10 seconds only.
- c) Resume Quiet condition automatically after 20 seconds if the call is not answered.
- d) The Unit will start decoding again when the 20 second period elapsed and the call remained unanswered.

Call Alarm - Continue mode

- a) Transmit an Acknowledge Tone to the Caller.
- b) Initially an alarm of four successive beeps is emitted for 20 seconds and then two successive beeps every four seconds continuously unless answered.
- c) The Quiet Condition is never resumed.
- d) The Unit continues to check if incoming codes have your Receiver Selcall ID even though the Quiet Condition is already opened. When detected, it will send an acknowledge Tone to the caller and then resets the Call Alarm.



For both of the above mentioned modes, transmission by using the PTT button is possible when the **TSQ** icon is flashing.

1. Switch Off the Power.
2. Press and hold **[POWER]** and **[MENU]**. The SELCALL Settings Menu will display (no tone will sound).
3. Press **[MENU]** repeatedly to select the Alarm mode setting - which is indicated on the display as AL.
4. Press **[SCAN]** to edit the setting. The current setting flashes.
5. Press **▲/▼** to select the desired Alarm mode from AUTO or CONT.
6. Press **[SCAN]** to exit the setting.
7. Press and hold **[ENTER]**, to save and exit programming mode.

Group Call Mode

The Group Tone period can be adjusted to increase the ability to identify group calls. Group 01 mode sets the tone period to 1 tone period (default). Group 02 mode sets the first group tone period to 3 tone periods.

1. Switch Off the Power.
2. Press and hold **[POWER]** and **[MENU]**. The SELCALL Settings Menu will display (no tone will sound).
3. Press **[MENU]** repeatedly to select the Group Call mode setting - which is indicated on the display as GROUP.
4. Press **[SCAN]** to edit the setting. The current setting flashes.
5. Press **▲/▼** to select the desired Group Call mode from 01 or 02.
6. Press **[SCAN]** to exit the setting.
7. Press and hold **[ENTER]**, to save and exit programming mode.

SELCALL Tone Frequency List

Tone No.	Tone Frequency (Hz)	Tone No.	Tone Frequency (Hz)
0	1981	8	1747
1	1124	9	1860
2	1197	A (Group)	2400
3	1275	B	930
4	1358	C	2247
5	1446	D	991
6	1540	E (Repeat)	2110
7	1640	F	1055

CTCSS Codes Table

Code No.	Frequency (Hz)	Code No.	Frequency (Hz)
"oF"	OFF	20	131.8
1	67.0	21	136.5
2	71.9	22	141.3
3	74.4	23	146.2
4	77.0	24	151.4
5	79.7	25	156.7
6	82.5	26	162.2
7	85.4	27	167.9
8	88.5	28	173.8
9	91.5	29	179.9
10	94.8	30	186.2
11	97.4	31	192.8
12	100.0	32	203.5
13	103.5	33	210.7
14	107.2	34	218.1
15	110.9	35	225.7
16	114.8	36	233.6
17	118.8	37	241.8
18	123.0	38	250.3
19	127.3		

DCS Codes Table

Code No.	DCS Code (Octal)	Code No.	DCS Code (Octal)	Code No.	DCS Code (Octal)
1	023	36	223	71	445
2	025	37	225	72	446
3	026	38	226	73	452
4	031	39	243	74	454
5	032	40	244	75	455
6	036	41	245	76	462
7	043	42	246	77	464
8	047	43	251	78	465
9	051	44	252	79	466
10	053	45	255	80	503
11	054	46	261	81	506
12	065	47	263	82	516
13	071	48	265	83	523
14	072	49	266	84	526
15	073	50	271	85	532
16	074	51	274	86	546
17	114	52	306	87	565
18	115	53	311	88	606
19	116	54	315	89	612
20	122	55	325	90	624
21	125	56	331	91	627
22	131	57	332	92	631
23	132	58	343	93	632
24	134	59	346	94	654
25	143	60	351	95	662
26	145	61	356	96	664
27	152	62	364	97	703
28	155	63	365	98	712
29	156	64	371	99	723
30	162	65	411	100	731
31	165	66	412	101	732
32	172	67	413	102	734
33	174	68	423	103	743
34	205	69	431	104	754
35	212	70	432		

Channel Bank List - Police (POL) (Only for UH9080)

Code No.	Frequency (MHz)	Code No.	Frequency (MHz)	Code No.	Frequency (MHz)
1	419.95000	26	468.27500	51	468.85000
2	465.50000	27	468.30000	52	468.87500
3	465.97500	28	468.32500	53	468.90000
4	466.25000	29	468.35000	54	468.92500
5	466.77500	30	468.37500	55	468.95000
6	466.85000	31	468.40000	56	468.97500
7	467.12500	32	468.42500	57	469.00000
8	467.65000	33	468.45000	58	469.02500
9	467.85000	34	468.47500	59	469.05000
10	467.87500	35	468.50000	60	469.07500
11	467.90000	36	468.52500	61	469.10000
12	467.92500	37	468.55000	62	469.12500
13	467.95000	38	468.57500	63	469.15000
14	467.97500	39	468.60000	64	469.17500
15	468.00000	40	468.61250	65	469.20000
16	468.02500	41	468.62500	66	469.22500
17	468.05000	42	468.63750	67	469.25000
18	468.07500	43	468.65000	68	469.27500
19	468.10000	44	468.67500	69	469.30000
20	468.12500	45	468.70000	70	469.32500
21	468.15000	46	468.72500	71	469.35000
22	468.17500	47	468.75000	72	469.37500
23	468.20000	48	468.77500	73	469.40000
24	468.22500	49	468.80000	74	469.42500
25	468.25000	50	468.82500	75	469.70000

Channel Bank List - Fire (Only for UH9080)

Code No.	Frequency (MHz)	Code No.	Frequency (MHz)	Code No.	Frequency (MHz)
1	410.60000	36	413.27500	71	462.86250
2	410.80000	37	413.30000	72	463.05000
3	411.01250	38	413.32500	73	463.12500
4	411.03750	39	413.35000	74	463.27500
5	411.06250	40	413.36250	75	463.32500
6	411.08750	41	413.37500	76	463.65000
7	412.32500	42	413.38750	77	463.70000
8	412.45000	43	413.40000	78	463.87500
9	412.47500	44	413.42500	79	465.02500
10	412.55000	45	414.52500	80	465.07500
11	412.57500	46	414.6625	81	465.17500
12	412.60000	47	415.11250	82	465.32500
13	412.65000	48	415.26250	83	465.65000
14	412.70000	49	415.41250	84	465.67500
15	412.72500	50	416.17500	85	466.55000
16	412.75000	51	416.28750	86	466.60000
17	412.80000	52	416.41250	87	466.85000
18	412.85000	53	416.51250	88	466.87500
19	412.87500	54	416.53750	89	466.92500
20	412.95000	55	416.67500	90	466.95000
21	413.02500	56	416.78750	91	466.97500
22	413.05000	57	416.91250	92	467.25000
23	413.07500	58	417.03750	93	467.42500
24	413.10000	59	417.17500	94	467.47500
25	413.11250	60	417.28750	95	467.50000
26	413.12500	61	417.41250	96	467.67500
27	413.13750	62	417.53750	97	467.77500
28	413.15000	63	419.15000	98	468.62500
29	413.16250	64	419.40000	99	469.52500
30	413.17500	65	419.96250	100	469.57500
31	413.18750	66	462.02500	101	469.60000
32	413.20000	67	462.20000	102	469.90000
33	413.21250	68	462.70000	103	471.85000
34	413.25000	69	462.78750	104	507.57500
35	413.26250	70	462.82500		

UHF-CB Channel Guidelines

Always listen on a channel (or observe the receive signal level meter) to ensure it is not already being used before transmitting.

Channels 5 and 35 are used for emergency channels.

CTCSS, DCS, TSQ and SELCALL will not operate on these channels.

Please follow these guidelines for channel use in Australia:

- Channels 05 and 35 are Emergency Channels.
- Channel 11 is a Calling Channel.
- Channels 22 and 23 are for telemetry and telecommand applications, channels 61, 62 and 63 are for future use and TX is inhibited on these channels.

General communication is accepted on all other channels with these guidelines:

- Channel 40 - road channel (Australia).
- Channels 01-08 (and 31-38), and Channels 41-48 (and 71-78) are repeater channels.



Important information - 80 Channel UHF-CB channel expansion

To provide all users additional channel capacity within the UHF-CB Band. The ACMA will change the majority of the current wideband 40 channel use to narrowband channel use. This allows for additional channels to be added, up to 80 Channels.

This simply means that the new narrowband radio you have purchased will have more channels than older radios. Please refer to the guidelines above and the channel chart for further channel information.

A list of currently authorised channels can also be obtained from the ACMA website in Australia and the MBIE website in New Zealand.

Interference / Poor Audio

When a new narrowband radio receives a signal from an older wideband radio the speech may sound loud - however the radio's built-in AVS (Automatic Volume Stabilizer) circuitry will detect and manage incoming audio to comparable levels.

Narrowband radios operating on CH41 - CH80 may encounter interference from a nearby wideband radios transmitting on high power on an adjacent channel (frequency).

When an older wideband radio receives a signal from a new narrowband radio the speech may sound quiet - the wideband radio user simply adjusts their radio volume for best performance.

The above situations are not a fault of the radio but a symptom of mixed wideband and narrowband radios in current use. It is expected that as older wideband radios are phased out this issue will be eliminated.



UHF-CB Channels and Frequencies

CH No.	Simplex Mode Transmit / Receive Frequency (MHz)	Duplex Mode Transmit Frequency (MHz)	CH No.	Simplex Mode Transmit / Receive Frequency (MHz)
1	476.425	477.175 (CH31)	21	476.925
2	476.450	477.200 (CH32)	22	476.950 (RX only)
3	476.475	477.225 (CH33)	23	476.975 (RX only)
4	476.500	477.250 (CH34)	24	477.000
5	476.525	477.275 (CH35)	25	477.025
6	476.550	477.300 (CH36)	26	477.050
7	476.575	477.325 (CH37)	27	477.075
8	476.600	477.350 (CH38)	28	477.100
9	476.625		29	477.125
10	476.650		30	477.150
11	476.675		31	477.175
12	476.700		32	477.200
13	476.725		33	477.225
14	476.750		34	477.250
15	476.775		35	477.275
16	476.800		36	477.300
17	476.825		37	477.325
18	476.850		38	477.350
19	476.875		39	477.375
20	476.900		40	477.400

UHF-CB Channels and Frequencies

CH No.	Simplex Mode Transmit / Receive Frequency (MHz)	Duplex Mode Transmit Frequency (MHz)	CH No.	Simplex Mode Transmit / Receive Frequency (MHz)
41	476.4375	477.1875 (CH 71)	61	future use 476.9375 (RX only)
42	476.4625	477.2125 (CH 72)	62	future use 476.9625 (RX only)
43	476.4875	477.2375 (CH 73)	63	future use 476.9875 (RX only)
44	476.5125	477.2625 (CH 74)	64	477.0125
45	476.5375	477.2875 (CH 75)	65	477.0375
46	476.5625	477.3125 (CH 76)	66	477.0625
47	476.5875	477.3375 (CH 77)	67	477.0875
48	476.6125	477.3625 (CH 78)	68	477.1125
49	476.6375		69	477.1375
50	476.6625		70	477.1625
51	476.6875		71	477.1875
52	476.7125		72	477.2125
53	476.7375		73	477.2375
54	476.7625		74	477.2625
55	476.7875		75	477.2875
56	476.8125		76	477.3125
57	476.8375		77	477.3375
58	476.8625		78	477.3625
59	476.8875		79	477.3875
60	476.9125		80	477.4125

Warranty

UNIDEN UH9060/UH9080 UHF CB Transceiver

IMPORTANT: Satisfactory evidence of the original purchase is required for warranty service

Please refer to our Uniden website for any details or warranty durations offered in addition to those contained below.

Warrantor: The warrantor is Uniden Australia Pty Limited ABN 58 001 865 498 (“Uniden Aust”).

Terms of Warranty: Uniden Aust warrants to the original retail purchaser only that the UH9060/UH9080 UHF CB Transceiver (“the Product”), will be free from defects in materials and craftsmanship for the duration of the warranty period, subject to the limitations and exclusions set out below.

Warranty period: This warranty to the original retail purchaser is only valid in the original country of purchase for a Product first purchased either in Australia or New Zealand.

Product	5 Years
Battery Pack & Accessories	1 Year

If a warranty claim is made, this warranty will not apply if the Product is found by Uniden to be:

- (A) Damaged or not maintained in a reasonable manner or as recommended in the relevant Uniden Owner’s Manual;
- (B) Modified, altered or used as part of any conversion kits, subassemblies or any configurations not sold by Uniden Aust;
- (C) Improperly installed contrary to instructions contained in the relevant Owner’s Manual
- (D) Repaired by someone other than an authorized Uniden Repair Agent in relation to a defect or malfunction covered by this warranty; or
- (E) Used in conjunction with any equipment, parts or a system not manufactured by Uniden.

Parts Covered: This warranty covers the Product and included accessories.

User-generated Data: This warranty does not cover any claimed loss of or damage to user-generated data (including but without limitation phone numbers, addresses and images) that may be stored on your Product.

Warranty

Statement of Remedy: If the Product is found not to conform to this warranty as stated above, the Warrantor, at its discretion, will either repair the defect or replace the Product without any charge for parts or service. This warranty does not include any reimbursement or payment of any consequential damages claimed to arise from a Product's failure to comply with the warranty.

Our goods come with guarantees that cannot be excluded under the Australian Consumer Law. You are entitled to a replacement or refund for a major failure and for compensation for any other reasonably foreseeable loss or damage. You are also entitled to have the goods repaired or replaced if the goods fail to be of acceptable quality and the failure does not amount to a major failure.

This warranty is in addition to and sits alongside your rights under either the COMPETITION AND CONSUMER ACT 2010 (Australia) or the CONSUMER GUARANTEES ACT (New Zealand) as the case may be, none of which can be excluded.

Procedure for obtaining warranty service: Depending on the country in which the Product was first purchased, if you believe that your Product does not conform with this warranty, you should deliver the Product, together with satisfactory evidence of your original purchase (such as a legible copy of the sales docket) to Uniden. Please refer to the Uniden website for the address details. You should contact Uniden regarding any compensation that may be payable for your expenses incurred in making a warranty claim. Prior to delivery, we recommend that you make a backup copy of any phone numbers, images or other data stored on your Product, in case it is lost or damaged during warranty service.

UNIDEN AUSTRALIA PTY LTD

Phone: 1300 366 895

Email: custservice@uniden.com.au

THANK YOU FOR BUYING A UNIDEN PRODUCT.

Uniden[®]

© 2016 Uniden Australia Pty Limited. Printed in Vietnam.
U01UT980ZZZ(0)