

# Uniden®

## **UH9000** **UHF CB Transceiver**

---

For more exciting new products please visit our website:  
Australia: [www.uniden.com.au](http://www.uniden.com.au)

---

# OWNER'S MANUAL

# Contents

---

<b>Introduction</b>	<b>4</b>
<b>Controls &amp; Connectors</b>	<b>6</b>
<b>Indicators</b>	<b>8</b>
<b>Included with your Transceiver</b>	<b>9</b>
<b>Optional Accessories</b>	<b>9</b>
<b>Connecting the Microphone</b>	<b>10</b>
<b>Mounting the MIC Hanger</b>	<b>11</b>
<b>Slide Mount Bracket</b>	<b>12</b>
<b>Operation</b>	<b>14</b>
Turning on the Power	14
LCD Flip	15
Setting the Squelch Level	15
Monitor	16
Setting the Volume	17
Selecting a Channel	17
Smart-Key Function	17
Voice Enhancer (EQL) Setting	18
Programming the Instant Priority CH-1	18
Programming the Instant Priority CH-2	18
Recalling the Instant Channel	18
Triple Watch	19
Transmitting	19
CTCSS & DCS	20
Scramble On/Off	20
Using Repeater Channels	21
Operating the UHF CB Radio in Duplex Mode	22
Scanning	23
Add/Remove Channels from SCAN Memory	23
Master Scan (MS) Mode	24
Open Scan (OS) Mode	25
Group Scan (GS) Mode	26
Priority Watch	27
Busy Channel Lockout	27
Call Tone	28
Roger Beep	28
Key Beep On/Off	28
Internal Speaker Setting On/Off	29
Mic Gain Setting	29
Backlight Color	29
Backlight Brightness	30
<b>Operation - Special Features</b>	<b>31</b>
Channel Banks	31
100 User programmable RX channels	32

# Contents

---

Manually Programme a RX channel	32
Search Extra Channel Range and Programme a RX Channel	33
<b>CTCSS Codes Table</b>	<b>34</b>
<b>DCS Codes Table</b>	<b>35</b>
<b>Channel Bank List - Police (POL)</b>	<b>36</b>
<b>Channel Bank List - Fire</b>	<b>37</b>
<b>UHF CB Channel Guidelines</b>	<b>38</b>
<b>UHF CB Channels &amp; Frequencies</b>	<b>39</b>
<b>Warranty</b>	<b>41</b>

# Introduction

---

The Uniden UH9000 is designed to provide you with years of trouble free service. Its rugged components and materials are capable of withstanding harsh environments. Please read this Operating Manual carefully to ensure you gain the optimum performance of the unit.



**NOTE**

The citizen band radio service is licensed in Australia by ACMA Radio-communications (Citizen Band Radio Stations) Class Licence and in New Zealand by MBIE General User Licence for Citizen Band Radio and operation is subject to conditions contained in those licenses.

## Features

- UHF-CB Narrow Band (NB) Transceiver Radio<sup>1</sup>
- 80 Channels
- 5W Transmission Power
- Built-in AVS Circuitry<sup>3</sup>
- Duplex Capability<sup>1</sup>
- Roger Beep Function On/Off
- 10 Different Call Tones

### Special Features

- 100 Extra User Programmable Receive Only Channels with Alpha Tag<sup>2</sup>
- Pre-Programmed Police, Fire & Ambulance Frequencies<sup>2</sup>
- One-Touch Smart Key
- Voice Enhancer (EQL)
- 2 Voice Scramble Setting

### Control Features

- Speaker Microphone with 5 Function Keys
- LCD Display with 7 Backlight Colors
- LCD Brightness
- Slide Mount Bracket
- +12V to +24V DC Power Input
- Under and Over Voltage Alert Function
- Signal Strength/Power Meter
- Volume Control (“oF”, “1” ~ “40”)
- External Speaker Jack
- Power On/Off Control Switch
- Front MIC Jack
- MIC Gain Control
- 9 Level Preset Squelch

## Channel Features

- Rotary Channel Select Knob
- Instant Channel Programming
- One touch Instant Channel Recalling
- Dual/Triple Watch with Instant Channels
- Group Scan and Priority Channel Watch
- Open Scan
- Master Scan
- Scan Channel Memory On/Off separately with Open Scan, Group Scan
- Busy Channel Lock-out Function
- 38 Built-in CTCSS (Continuous Tone Coded Squelch System) codes
- 104 additional DCS (Digital Coded Squelch) codes that are user selectable

<sup>1</sup> Refer to page 34 - page 40 for channel information

<sup>2</sup> Available frequencies & channels are within 400-520MHz Band only in 12.5kHz steps. Police, Fire & Ambulance reception is unencrypted analogue.

<sup>3</sup> AVS - Automatic Volume Stabilizer detects and manages incoming audio to comparable levels.

# Introduction

---

## Preventive Maintenance

The following system checks should be made every six to twelve months:

- Check the Standing Wave Ratio (SWR).
- Inspect the tightness of all electrical connections.
- Inspect the antenna coaxial cable for wear or breaks on the shielding.
- Inspect the tightness of all screws and other mounting hardware.

## Troubleshooting

Should the unit malfunction or perform poorly, follow these procedures:

If the transceiver is completely inoperative: Check the power cord and fuse.

If there is trouble with receiving: Check the VOLUME control setting. Be sure the SQUELCH is adjusted properly. Possibly the radio is over-squelched.

If there is trouble with transmitting: Check that the transmission line (coaxial cable) is securely connected to the ANTENNA connector. Check that the antenna is fully extended for proper operation. Check that all transmission line (coaxial cable) connections are secure and free of corrosion.

# Controls & Connectors

## Base (Front & Rear)

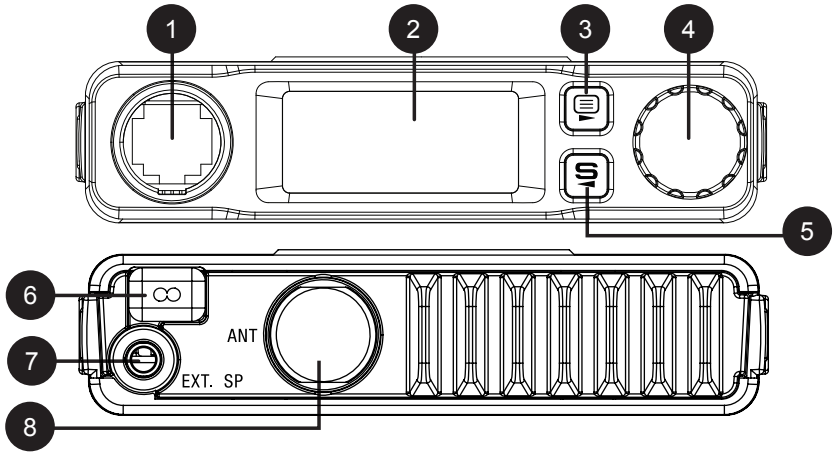

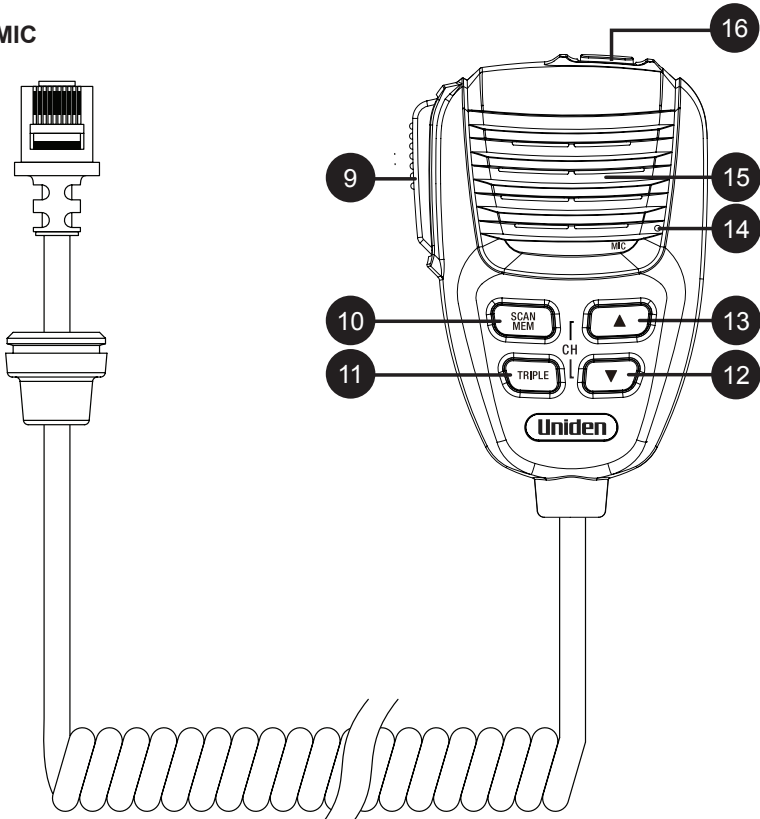

## Speaker MIC





# Controls & Connectors

---

## Base (Front & Rear)

- 1 MIC Jack
- 2 Liquid Crystal Display (LCD)
- 3  Menu Button  
/Monitor function  
(press & hold)  
▶ - Move Selection
- 4 PUSH control - Volume  
/Channel Select (press)  
/Power On/Off (press & hold)  
  
ROTARY control - Volume  
/Channel /Menu Item  
Selector
- 5  Channel Scan button  
/Scan Memory  
(press & hold)  
◀ - Move Selection
- 6 Power Input Connection
- 7 EXT SP - External Speaker Jack
- 8 UHF Antenna Connection

## Speaker MIC



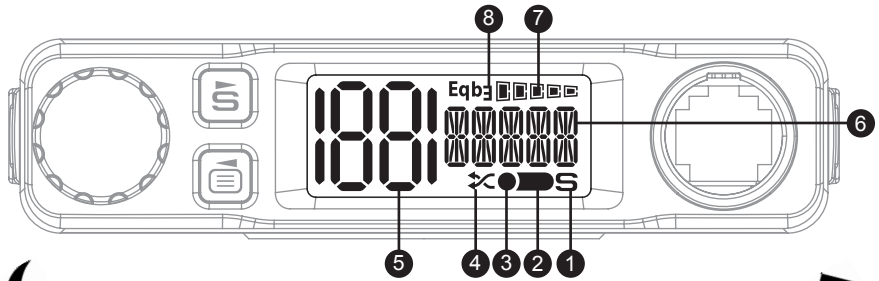

- 9 PTT - Push To Talk Button
- 10 SCAN - Scan Button  
/MEM - Memory Button
- 11 TRIPLE - Triple Watch Button
- 12  - Channel Down Button  
- Select Down Button
- 13  - Channel Up Button  
- Select Up Button
- 14 MICROPHONE
- 15 SPEAKER
- 16 SMART - Multiple function

# Indicators

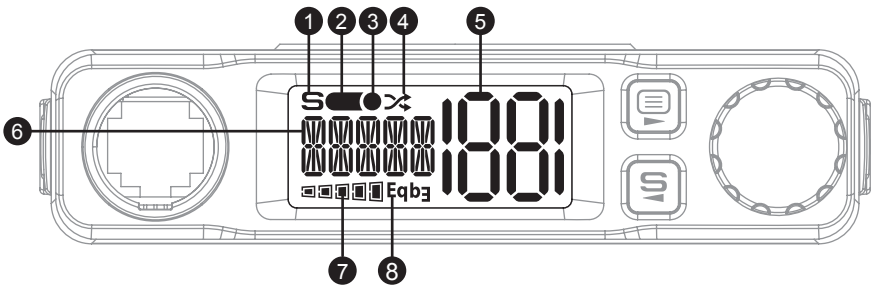

FLIP LCD DISPLAY (refer to page 15)



- 1 **S** - Scan
- 2  - Instant Channel
- 3  - Scan CH Memory
- 4  - Scramble
- 5 **1881** - Channel Indication /  
Menu Item Setting
- 6  - Information Indicator  
- (Menu Item/ Code Number /  
Alpha tag etc.)
- 7  - SRF Meter
- 8 **Eq** - Equalizer



# Included with your UH9000 Transceiver

---



Speaker Microphone  
(MK900)

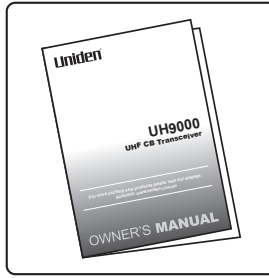

Owner's Manual

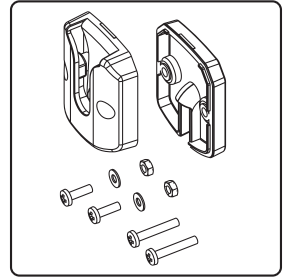

Microphone Hanger with  
screws, washers

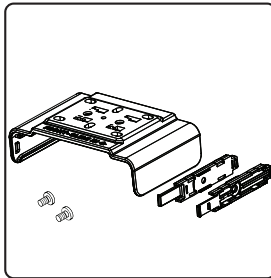

Din Mount Sleeve,  
Removable Bracket &  
Screws

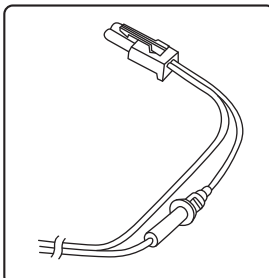

DC Power Cord  
with fuse

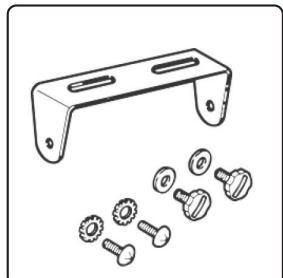

Mounting Bracket,  
Mounting Screws,  
Washer Stars And  
Screws

## Optional Accessories

- UHF Antenna
- External Speaker

Visit the UH9000 page on the website for more information on the availability of optional accessories:

[www.uniden.com.au](http://www.uniden.com.au) for Australia

# Connecting the Microphone

---

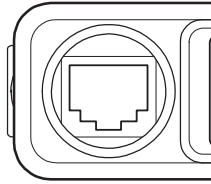

## **MIC Jack**

Push the MIC plug at the end of the microphone into the MIC jack until the connection locks into place. Gently tug the MIC cord to test that the connection is locked. Use the rubber cover which is on the MIC cord to seal the MIC jack entry from dust.

## **Disconnecting the MIC from the MIC Jack**

Pull back the rubber cover and move it down along the cord. Using the flat blade of a screwdriver or similar object carefully push the lock tab of the MIC plug towards the MIC cord and at the same time tug on the MIC cord to draw back the MIC plug.

# Mounting the MIC Hanger

---

The Microphone Hanger comes in two parts. How and where you mount the MIC hanger will determine which parts to use.

## Conventional Mounting with Screws

Use the front part of the MIC Hanger only.  
Locate a suitable mounting position and mark and drill two 3mm holes.  
Fix the MIC Hanger into place with screws.

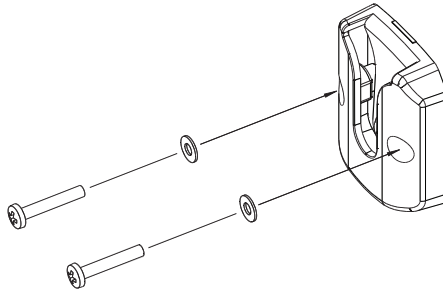

## Conventional Mounting with Double Sided Tape (not supplied)

High quality Double-Sided tape can be found at good retail stores.  
Secure the front and back pieces of the MIC Hanger using the supplied binding screws.

Locate a suitable mounting position.

Apply high quality Double-Sided tape onto the flat area of the MIC Hanger back piece and then press firmly to the mounting position.

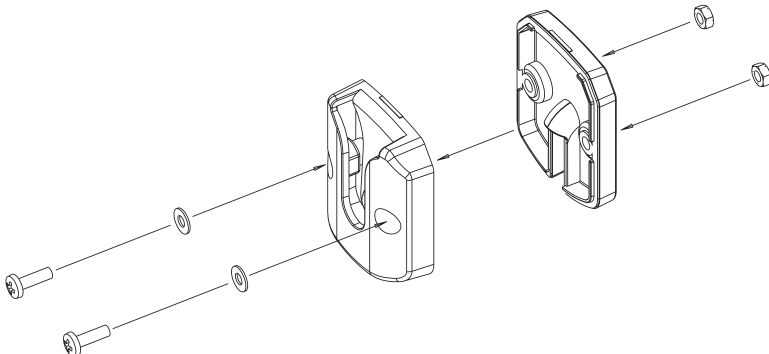

# Slide Mount Bracket

---

## How to attach Slide Mount Bracket?

When you unpack the box, ensure that you have the slide mount bracket, guide rails and the screws.

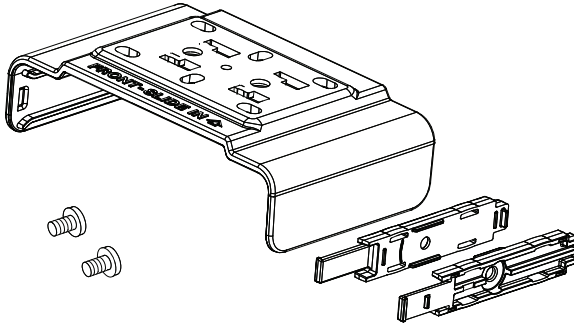

Align the guide rails along the side of the base and insert them into the slots provided. Then use the screws to lock them securely in position.

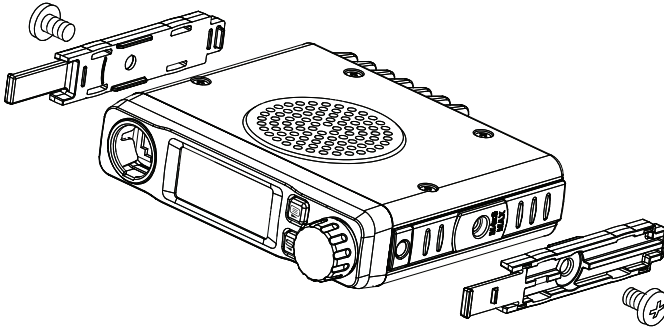

BASE unit with secured guide rails.

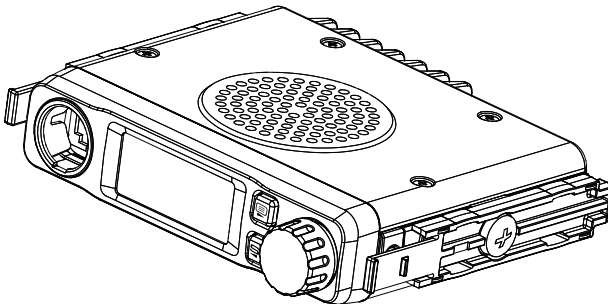

# Slide Mount Bracket

---

Slide the bracket along the guide rails to attach the bracket to the unit.

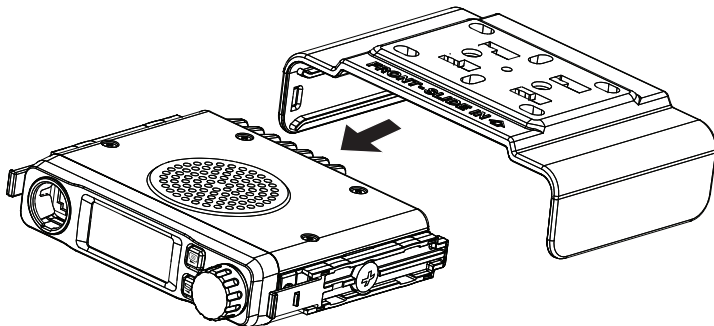

Over the BASE unit

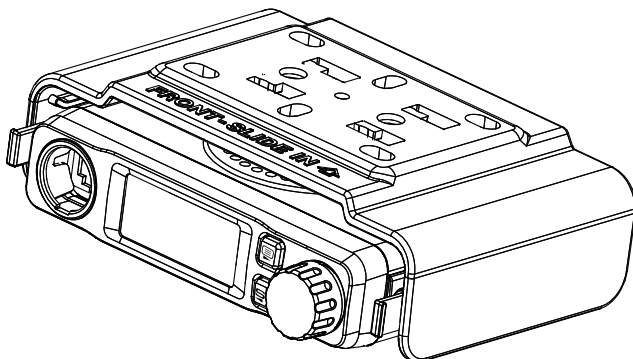

Under the BASE unit

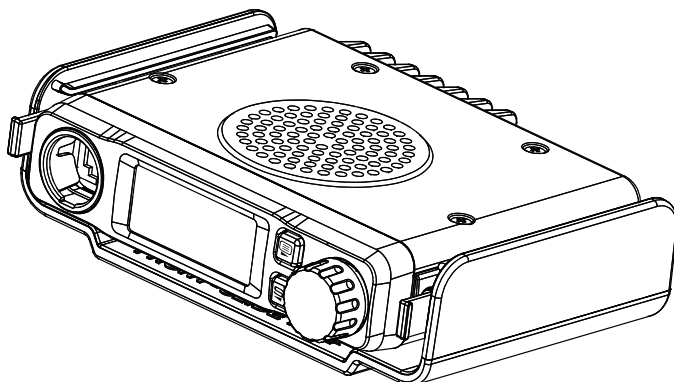

# Operation

---

## Turning on the Power

Press and hold rotary knob.

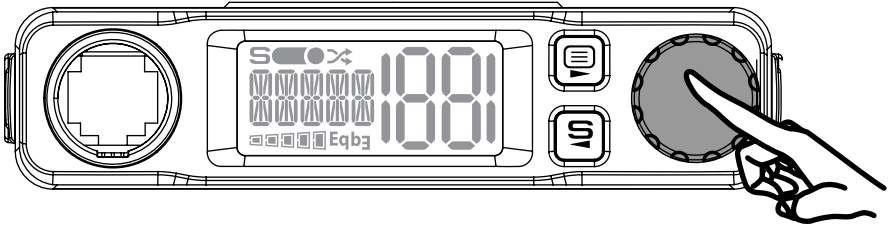

### Low-Voltage/High-Voltage Alert

The UH9000 can operate on 12VDC (13.8V) or 24VDC (27.6V) power supply, with the range between 10.8VDC to 28.8VDC.







**NOTE**

If the power supply voltage exceeds approx. 30VDC, an alert tone sounds and **HI** flashes for 5 seconds. The power source must not exceed 32VDC otherwise permanent damage may occur to your radio, which may not be covered by the manufacturer's warranty.

If the input voltage falls below approx. 10VDC, **LO** flashes for 5 seconds. The power turns off automatically if voltage falls below 9.0VDC.

Switch your UH9000 OFF and disconnect it from the power source, before locating the cause of the power supply problem.

## LCD Flip

1. Press  20 times. The Flip setting flashes.
2. Turn the rotary knob or press  /  on the microphone to change the flip orientation.
3. Press and hold  to save & exit from the menu mode.

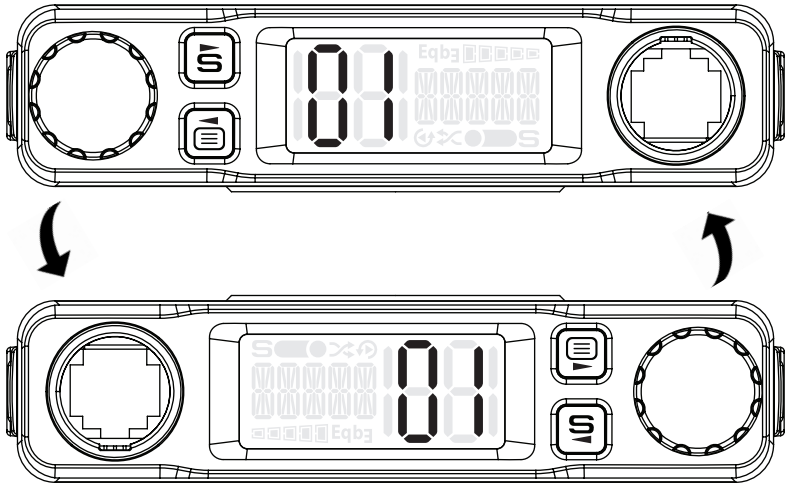

## Setting the Squelch Level

Press  once, SQL shows and the current squelch level will flash.

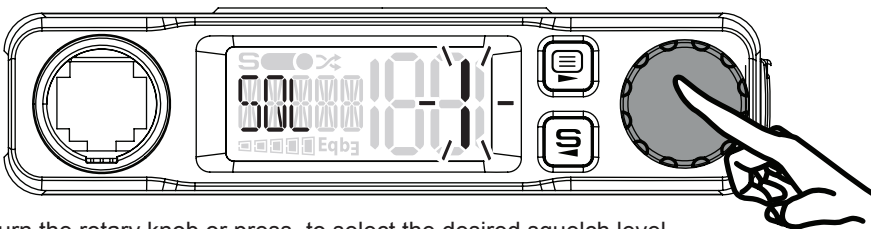

Turn the rotary knob or press  to select the desired squelch level.



If a button is not pressed within 10 seconds the UHF CB Radio will automatically exit the Menu Mode.

# Operation

- 1 - max sensitivity (min squelch)
- 5 - med sensitivity (med squelch)
- 9 - min sensitivity (max/tight squelch)



## NOTE

You must select a channel which is not in use before setting the SQUELCH control. (see page 17 for "Selecting a Channel").

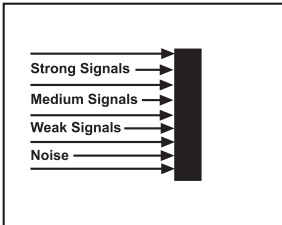

Think of the squelch control as a gate. If you turn Squelch fully clockwise it raises the 'Squelch gate' so high that no signals get through.

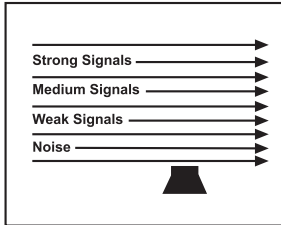

If you turn Squelch fully counter clockwise it lowers the 'Squelch gate' so low that noise gets through.

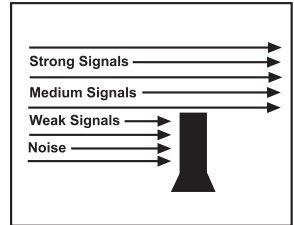

To set the 'Squelch Gate' to the desired level, turn the rotary knob counter-clockwise until you hear noise. Then carefully turn the rotary knob clockwise until the noise fades. Now only strong signals get through.

## Monitor

Press and hold  the squelch and receive all weak signals.

Press and hold  again to cancel.

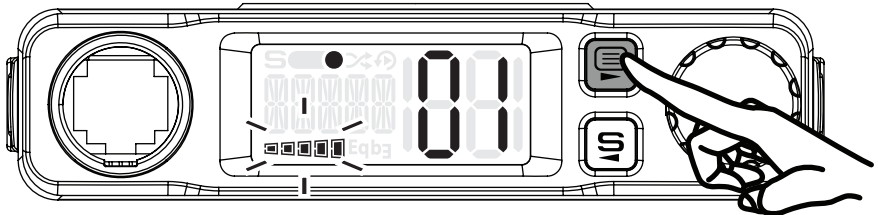



# Operation

---

## Setting the Volume

Turn the rotary knob to select desired volume.

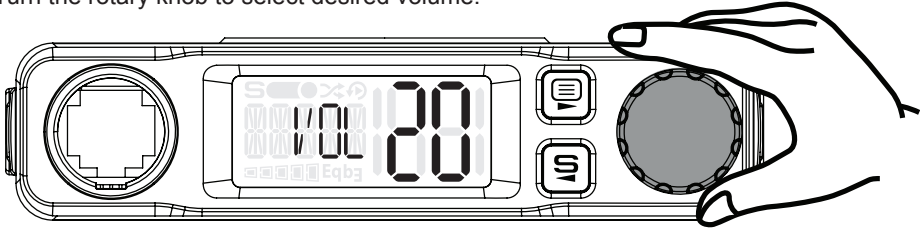

## Selecting a Channel

Press the rotary knob once and turn the rotary knob to select channel.

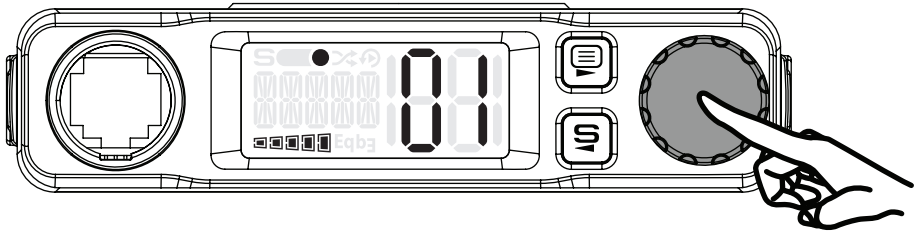

For your reference a list of the available channels, corresponding frequencies and guidelines for their use is printed on page 34 - page 40. For Australia, Channels 05 and 35 are reserved for Emergency Calls.

## Smart-Key Function

The smart key **[S]** provides one touch access to one of these functions; Instant Channel, Call Tone or Equalizer.

Press and hold **[S]** to change the **SMART** key function between the three options.

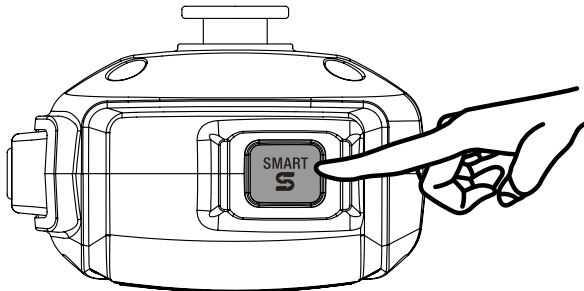

# Operation

---

## Voice Enhancer (EQL) Setting



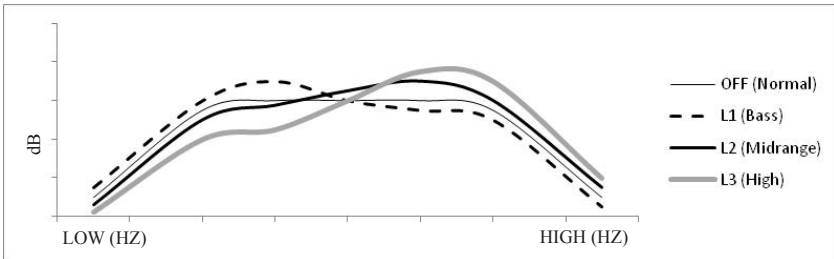

Choose from 4 different receive audio level settings to provide a natural Voice Enhancer for super clarity and performance.

Press **[S]**, when in **SMART** key EQL mode, to change the setting between;





- OFF : Normal - Standard of FLAT
- L1 : Bass - Enhancing the low frequency, the sound quality becomes mild and easy to listening, not causing fatigue
- L2 : Midrange - Enhancing midrange frequency, the sound quality becomes clear
- L3 : High - Enhancing the high frequency, the sound quality becomes sharp



## Programming the Instant Priority Channel-1

1. Press  7 times. P1 and current channel setting flashes.
2. Turn the rotary knob at the base or press  /  on the microphone to select the desired channel.
3. Press and hold  to save and exit.

## Programming the Instant Priority Channel-2

1. Press  8 times. P2 and current channel setting flashes.
2. Turn the rotary knob at the base or press  /  on the microphone to select the desired channel.
3. Press and hold  to save and exit.

## Recalling the Instant Channel

Press **[S]** when Smart Key is set to Instant Channel function.

---

# Operation

---

## Triple Watch

Triple watch will continuously monitor the two Instant Channel and the current channel for activity (see Programming the Instant Priority Channel-1/Channel-2, page 18).

Press **[TRIPLE]** to switch Triple watch On/Off.

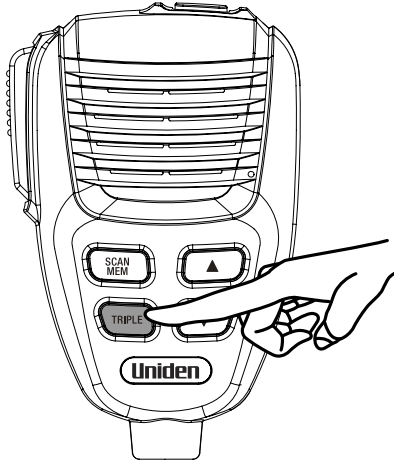

NOTE

- Every 1.5 seconds the Instant channel is monitored for 40msec.
- Triple watch function stops temporarily when receiving a signal.
- Triple watch function is invalid in Scan mode.

## Transmitting

The UH9000 transmits only on UHF-CB Channels.



NOTE

For your reference a list of the available channels, corresponding frequencies and guidelines for their use and selection is printed on page 34 - page 40. For Australia, Channels 05 and 35 are reserved for Emergency Calls.





Select the desired channel. Press the microphone's **[PTT]** button and speak normally into the microphone. Hold it approx. 7cm from your mouth. Release **[PTT]** to end the transmission and listen for a reply.

# Operation

---





## CTCSS (Continuous Tone Coded Squelch System) & DCS (Digital Coded Squelch)

Turn the rotary knob to desired channel to use CTCSS or DCS.

1. Press  3 times. Sub-code setting appears.
2. Turn the rotary knob or press  /  on the microphone to select desired CTCSS code 01 - 38 or DCS code 01 - 104.  
To turn off CTCSS/DCS select the **oF** code.
3. Press & hold  to save & exit menu mode.

## Scramble On/Off

Scramble enables private communications by scrambling the voice signal. This prevents users without descrambler equipment or a compatible unit understanding the conversation. Select desired channel.

1. Press  4 times. The Scramble setting flashes.
2. Turn the rotary knob or press  /  on the microphone to change the setting between OFF, 1 (Scramble-1), 2 (Scramble-2).
3. Press and hold  to save & exit from the menu mode.



NOTE

For safety purposes Scramble is invalid on channel 5, 11, 22, 23, 35, Extra RX, Police and Fire (Channel 22 & 23 is valid in NZ)

# Operation

---

## Using Repeater Channels

UHF CB repeaters are used to retransmit or relay your signal. Repeaters will extend the range of your radio and overcome the shielding effect caused by solid obstructions. In normal Simplex operation, your radio transmits on one particular frequency and receives on that same frequency.

If there is a barrier that partially blocks your transmitted signal, the probability of another radio receiving the signal is very slim. Hills, tall buildings, metallic structures,...etc tend to act as a screen between radios.

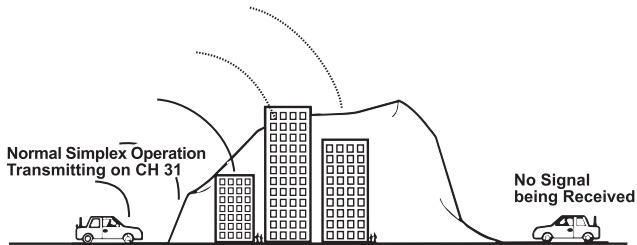

Standard Operation without the aid of a Repeater station.

The signal coming from your radio is received by the Repeater Station and the re-transmitted at the same time on another channel. This operation is called "Duplexing".

For example,

CH01 on Duplex Mode will Receive on CH01 but Transmit on CH31

CH02 on Duplex Mode will Receive on CH02 but Transmit on CH32 etc...

**If you transmit on CH01 Duplex mode, you are actually transmitting on CH31 the repeater station down-converts your signal and retransmits on CH01.**

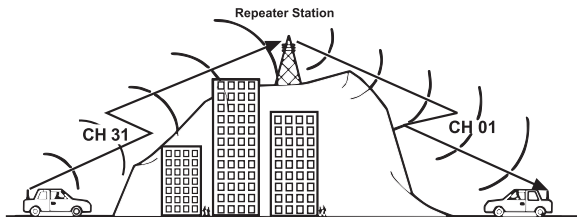





Operation with the aid of a Repeater Station (Duplex).

# Operation

---

## Operating the UHF CB Radio in Duplex Mode

For this example we are adopting CH01 as the channel being used in your area for repeater use.

1. Press  5 times. The duplex setting flashes.
2. Turn the rotary knob or press  /  on the microphone to change the setting between simplex and duplex (“ r ” for repeater channels 01 - 08 or “ n “ for repeater channels 41 - 48).
3. Press  to store the setting.
4. Press and hold  to save & exit the menu mode. Only channels 01 - 08 and 41 - 48 are available for Duplex.



NOTE

- Check with your local Retailer for information on available repeaters.

# Operation

---

## Scanning

The Scan feature allows you to search for active channels automatically.

There are 3 scanning modes;

Open Scan (OS),

Group Scan (GS) and





Master Scan (MS)

During SCAN the UH9000 only checks channels or frequencies that are in the SCAN Memory, which are indicated by the M (memory) icon (●). The UH9000 maintains two SCAN Memories; one for Open Scan (OS) mode and the other for Group Scan (GS) mode, to give you flexibility and allow you to use the radio more effectively.





- Group Scan and Master Scan modes share the same SCAN Memory.

Furthermore, any combination of the three channel groups can be scanned with channel banks during scan (except Master Scan) to select the desired channel groups.

1. Press  or press **[SCAN/MEM]** on the microphone and scanning starts. The **S** icon appears. The scan direction can be changed at any time by pressing  /  on the microphone.
2. To deactivate SCAN, press  or press **[SCAN/MEM]** on the microphone.

## Add/Remove Channels from SCAN Memory

1. Select which Scanning Mode you wish to use; OS, GS or MS.
2. Select the channel you want to store.
3. Press and hold  or **[SCAN/MEM]** button on the microphone to store. The ● icon appears and a short tone is heard.
4. To remove the channel from SCAN memory, press and hold  or **[SCAN/MEM]** button on the microphone once more. The ● icon disappears.

# Operation

---

## MASTER SCAN Mode

MASTER SCAN is the default scan mode and is enabled to allow continual communication across congested channels. Master Scan scans channels stored into GS Memory and only opens the squelch for signals with the correct subcode (CTCSS or DCS tone).

To achieve this, all radios in your group must have the same channels in GS memory (group channels) and use the same Subcode (CTCSS or DCS tone). By scanning only group channels, radios in the network will be able to detect and receive group transmissions- continual communication without interruption.

When transmitting in this mode, the radio switches to an unused group channel if it detects another signal with no code, or the wrong code, on the channel last used by the group. In this way, all group users will be able to have continual communication to or from other users.

CH09-CH20 are stored into GS Memory and CTCSS01 is set for MASTER SCAN Subcode by default. The GS memory can be changed, channel by channel, if desired







- but for Master Scan to work effectively each radio in the group must have the same channels in its GS memory.

To add/remove channels from GS SCAN Memory, refer previous section.



RX only Channels (CH22, CH23, CH61, CH62 and CH63), Emergency Channels (CH05, CH35), User Programmable RX Channels (CH81 to CH180) and Police or Fire (& Ambulance) channels group will not be included in MASTER SCAN Mode even though stored into GS Memory Also channels for which Duplex Setting are On will be skipped in MASTER SCAN Mode.

To select MASTER SCAN Mode:

1. Press  9 times. The scan setting flashes.
2. Turn the rotary knob or press  /  on the microphone till MASTR flashes and press  to save scan type setting.
3. Turn the rotary knob or press  /  to select desired preset GS memory group and press  to save the setting.

P-: Master Scan is ON with the current GS channel memory. Open/Group Scan is disabled.

P1: Master Scan is ON with loading CH09-20 in GS.

P2: Master Scan is ON with loading CH21-30, 39, 40 in GS.

P3: Master Scan is ON with loading CH49-60 in GS.

P4: Master Scan is ON with loading CH61-70, 79, 80 in GS.



# Operation

---



4. Turn the rotary knob or press  /  to select desired CTCSS code 01 - 38 or DCS code 01 - 104

**CTCSS:**



**DCS:**



5. Press  to store the setting.
6. Press and hold  to save & exit the menu mode.





## Open Scan (OS) Mode

All UHF-CB, user-programmed extra RX channels, Police and Fire & Ambulance frequencies have been added to the OS SCAN Memory for convenience. To add/remove channels from OS SCAN Memory, refer to page 23.

Allows continuous scanning of all selected channels. If an active channel is found, scanning will stop on that channel. If the received signal ceases, the unit will wait 2 seconds for the signal to return, otherwise scanning resumes.

After transmission in scan mode, the unit will wait 20 seconds for the signal to return, otherwise scanning resumes.

To select OS Scan Mode:

1. Press  9 times. The SCAN setting flashes.
2. Turn the rotary knob or press  /  on the microphone till OPEN flashes and press  to save scan type setting.
3. Press and hold  to save and exit from the Menu mode.

# Operation

---

## Group Scan (GS) Mode

GS Mode has CH09 to CH20 in the SCAN Memory by default. Channels must be stored to the GS SCAN Memory before group scan can start. To add/remove channels from GS SCAN Memory, refer to page 23.





Includes the accessory feature Priority Watch which allows you to only monitor Instant Priority Channel-1 while scanning (see page 18 for setting Instant Priority Channel and page 27 to turn on Priority Watch).

GS Scanning checks the Instant Priority Channel for activity regularly when Priority Watch is ON.

If the Priority Channel becomes active the radio will stay on that channel for as long as the signal is present. If the received signal ceases, Priority Scanning continues after 2 seconds.

If scanning stops on a channel which is not a Priority Channel, UHF CB Radio will continue monitoring the Priority Channel for activity while listening to the active one.

To select GS Scan Mode:





1. Press  9 times. The SCAN setting flashes.
2. Turn the rotary knob or press  /  on the microphone till GROUP flashes and press  to save scan type setting.
3. Press and hold  to save and exit from the Menu mode.

# Operation

---

## Priority Watch

To switch Priority Watch On/Off;

1. Press  6 times. The Priority Watch setting flashes.
2. Turn the rotary knob or press  /  on the microphone to change the setting between ON or OFF.
3. Press and hold  to save & exit from the menu mode.







If SCAN is deactivated while it is tuned to an active channel, the UH9000 will stay on that active channel. If none of the channels are active, the UH9000 will reinstate the scan start channel.



If OS/GS Scanning is initiated when there are no channels programmed in OS/GS memory, an error tone will be heard and scanning will not start (see Add/Remove Channels from SCAN Memory, page 23).

## Busy Channel Lockout

If the channel is already in use, you can prevent the UHF CB Radio from transmitting . This is particularly important when using CTCSS/DCS.





1. Press  12 times. The BCL setting flashes.
2. Turn the rotary knob or press  /  on the microphone to change the setting between ON or OFF.
3. Press and hold  to save & exit from the menu mode.

# Operation





---

## Call Tone





The radio is equipped with 10 selectable call tones that will be transmitted when **[S]** is press when Smart key is set to Call Tone function.

1. Press  13 times. The CTONE setting flashes.
2. Turn the rotary knob or press  /  on the microphone to change the selection. The 10 call tones are CTONE 1 to CTONE 10.
3. Press and hold  to save & exit from the menu mode.

## Roger Beep

1. Press  14 times. The ROGER setting flashes.
2. Turn the rotary knob or press  /  on the microphone to change the setting between ON or OFF.
3. Press and hold  to save & exit from the menu mode.

## Key Beep On/Off





1. Press  15 times. The BEEP setting flashes.
2. Turn the rotary knob or press  /  on the microphone to change the setting between OFF, 1, 2, 3... 7.
3. Press and hold  to save & exit from the menu mode.

# Operation

---





## Internal Speaker

The internal speaker can be switch ON or OFF.





1. Press  16 times. The INTSP setting flashes.
2. Turn the rotary knob or press  /  on the microphone to change the setting between ON or OFF.
3. Press and hold  to save & exit from the menu mode.

## Mic Gain Control

To control the gain (sensitivity) of microphone.

1. Press  17 times. The MIC-G setting flashes.
2. Turn the rotary knob or press  /  on the microphone to change the Mic Gain setting between (Low) -6, -5, -4....0, 1, 2, 3 (High)
3. Press and hold  to save & exit from the menu mode.





## Backlight Color

1. Press  18 times. The color setting flashes.
2. Turn the rotary knob or press  /  on the microphone to select the color from CLEAR/ BLUE / RED / PURPLE/ GREEN / CYAN / YELLOW.
3. Press and hold  to save & exit from the menu mode.

# Operation

---

## Backlight Brightness

1. Press  19 times. The BRIGHT setting flashes.
2. Turn the rotary knob or press  /  on the microphone to change the setting between Off (oF), 1(Lo), 2(mid) and 3(Hi).
3. Press and hold  to save & exit from the menu mode.

# Operation - Special Features

## Channel Banks

The UH9000 has three banks (groups) of channels to select from;

<b>CB</b>	UHF CB + User programmable RX channels <sup>1</sup>
<b>POL (Police)</b>	Pre-programmed Police frequencies <sup>2</sup>
<b>FIRE</b>	Pre-programmed Fire & Ambulance frequencies <sup>2</sup>

When the **POL** is showing then pre-programmed police channels will be available. When the **FI** is showing then pre-programmed fire & ambulance channels will be available. The police, fire & ambulance frequencies have channel numbers.



POLICE CH:



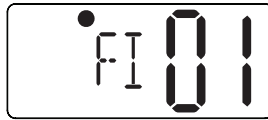

FIRE CH:

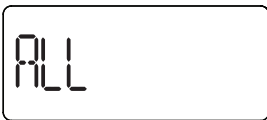
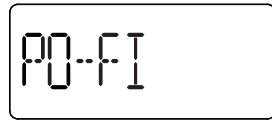
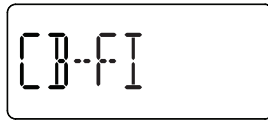
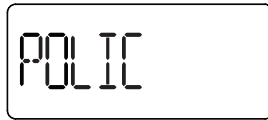

To select channel banks:

1. Press  2 times.
2. Turn the rotary knob or press  /  on the microphone to select the desired channel bank(s) combination. The channel banks can be selected as follows;



3. Press and hold  to save and exit menu mode.



### NOTE

<sup>1</sup> Available frequencies & channels are within 400-520MHz Band only in 12.5kHz steps.

<sup>2</sup> Police, Fire & Ambulance reception is unencrypted analogue.

For your reference a list of the available channels, corresponding frequencies and guidelines for their use is printed on page 34 - page 40. For Australia, Channels 05 and 35 are reserved for Emergency Calls.

# Operation - Special Features

---

## 100 User Programmable RX Channels

The UH9000 has 100 receive only channels (CH81 to CH180) which can be programmed with frequencies ranging from 400-520MHz (in 12.5kHz steps). The extra RX channels only appear, as part of the CB channel bank, when a frequency has been programmed to a channel. There are two ways to programme RX channels;

1. If you know the frequency you may manually programme it to a channel.
2. Search extra channel range and programme it to a channel.

Furthermore, the RX channels can be Alpha Tagged (given a name) if desired.

## Manually Programme a RX Channel



Turn power off.

Press and hold  while turning power on (pressing rotary knob).

The channel indicator flashes the lowest available empty channel. You may use the rotary channel selector to select another channel from CH81 - CH180.



Press the rotary knob. The MHz digits of the frequency indicator flashes. Turn the rotary knob to select the desired MHz.

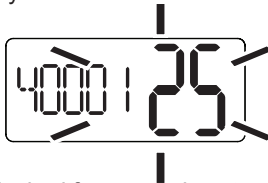

Press  and  to change from the MHz digits to the kHz digits of the frequency, turn the rotary knob to select the desired kHz.



When desired frequency is entered press the rotary knob to move to Alpha tag selection.

A cursor flashes in the first alpha position. Use  or  to shift between cursor positions. If you do not wish to name the channel then skip this step.

When finished press rotary knob. A long confirmation tone sounds to indicate the new channel is programmed. The channel flashes to enable selection for programming of next channel if desired.

Press **[PTT]** on the microphone to exit programming mode.



# Operation - Special Features

---

## Search Extra Channel Range and Programme a RX Channel

UH9000 can search extra channel range (400MHz-520MHz) per 12.5KHz step. Then you can store the stay frequency to extra channel.

Turn power off



Press and hold  while turning power on (pressing rotary knob).

The channel indicator flashes the lowest available empty channel. You may use the rotary channel selector to select another channel from CH81 - CH180.

Press and hold  to start scanning. Turn the rotary knob clockwise for ascending order or counterclockwise for descending order.

If an active frequency channel found, scanning will stop on that frequency. To skip, turn the rotary knob to continue scanning.

When desired frequency is found, press the rotary knob to move to Alpha tag selection.

A cursor flashes in the first alpha position. Use  or  to shift between cursor positions. If you do not wish to name the channel then skip this step.

When finished press rotary knob. A long confirmation tone sounds to indicate the new channel is programmed. The channel flashed to enable selection for programming of next channel if desired.

Press **[PTT]** on the microphone to exit programming mode.

# CTCSS Codes Table

---

Code No.	Frequency (Hz)	Code No.	Frequency (Hz)
"OFF"	OFF	20	131.8
1	67.0	21	136.5
2	71.9	22	141.3
3	74.4	23	146.2
4	77.0	24	151.4
5	79.7	25	156.7
6	82.5	26	162.2
7	85.4	27	167.9
8	88.5	28	173.8
9	91.5	29	179.9
10	94.8	30	186.2
11	97.4	31	192.8
12	100.0	32	203.5
13	103.5	33	210.7
14	107.2	34	218.1
15	110.9	35	225.7
16	114.8	36	233.6
17	118.8	37	241.8
18	123.0	38	250.3
19	127.3		

# DCS Codes Table

Code No.	DCS Code (Octal)	Code No.	DCS Code (Octal)	Code No.	DCS Code (Octal)
1	023	36	223	71	445
2	025	37	225	72	446
3	026	38	226	73	452
4	031	39	243	74	454
5	032	40	244	75	455
6	036	41	245	76	462
7	043	42	246	77	464
8	047	43	251	78	465
9	051	44	252	79	466
10	053	45	255	80	503
11	054	46	261	81	506
12	065	47	263	82	516
13	071	48	265	83	523
14	072	49	266	84	526
15	073	50	271	85	532
16	074	51	274	86	546
17	114	52	306	87	565
18	115	53	311	88	606
19	116	54	315	89	612
20	122	55	325	90	624
21	125	56	331	91	627
22	131	57	332	92	631
23	132	58	343	93	632
24	134	59	346	94	654
25	143	60	351	95	662
26	145	61	356	96	664
27	152	62	364	97	703
28	155	63	365	98	712
29	156	64	371	99	723
30	162	65	411	100	731
31	165	66	412	101	732
32	172	67	413	102	734
33	174	68	423	103	743
34	205	69	431	104	754
35	212	70	432		

# Channel Bank List - Police (POL)

Code No.	Frequency (MHz)	Code No.	Frequency (MHz)	Code No.	Frequency (MHz)
1	419.95000	26	468.27500	51	468.85000
2	465.50000	27	468.30000	52	468.87500
3	465.97500	28	468.32500	53	468.90000
4	466.25000	29	468.35000	54	468.92500
5	466.77500	30	468.37500	55	468.95000
6	466.85000	31	468.40000	56	468.97500
7	467.12500	32	468.42500	57	469.00000
8	467.65000	33	468.45000	58	469.02500
9	467.85000	34	468.47500	59	469.05000
10	467.87500	35	468.50000	60	469.07500
11	467.90000	36	468.52500	61	469.10000
12	467.92500	37	468.55000	62	469.12500
13	467.95000	38	468.57500	63	469.15000
14	467.97500	39	468.60000	64	469.17500
15	468.00000	40	468.61250	65	469.20000
16	468.02500	41	468.62500	66	469.22500
17	468.05000	42	468.63750	67	469.25000
18	468.07500	43	468.65000	68	469.27500
19	468.10000	44	468.67500	69	469.30000
20	468.12500	45	468.70000	70	469.32500
21	468.15000	46	468.72500	71	469.35000
22	468.17500	47	468.75000	72	469.37500
23	468.20000	48	468.77500	73	469.40000
24	468.22500	49	468.80000	74	469.42500
25	468.25000	50	468.82500	75	469.70000

# Channel Bank List - Fire

Code No.	Frequency (MHz)	Code No.	Frequency (MHz)	Code No.	Frequency (MHz)
1	410.60000	36	413.27500	71	462.86250
2	410.80000	37	413.30000	72	463.05000
3	411.01250	38	413.32500	73	463.12500
4	411.03750	39	413.35000	74	463.27500
5	411.06250	40	413.36250	75	463.32500
6	411.08750	41	413.37500	76	463.65000
7	412.32500	42	413.38750	77	463.70000
8	412.45000	43	413.40000	78	463.87500
9	412.47500	44	413.42500	79	465.02500
10	412.55000	45	414.52500	80	465.07500
11	412.57500	46	414.66250	81	465.17500
12	412.60000	47	415.11250	82	465.32500
13	412.65000	48	415.26250	83	465.65000
14	412.70000	49	415.41250	84	465.67500
15	412.72500	50	416.17500	85	466.55000
16	412.75000	51	416.28750	86	466.60000
17	412.80000	52	416.41250	87	466.85000
18	412.85000	53	416.51250	88	466.87500
19	412.87500	54	416.53750	89	466.92500
20	412.95000	55	416.67500	90	466.95000
21	413.02500	56	416.78750	91	466.97500
22	413.05000	57	416.91250	92	467.25000
23	413.07500	58	417.03750	93	467.42500
24	413.10000	59	417.17500	94	467.47500
25	413.11250	60	417.28750	95	467.50000
26	413.12500	61	417.41250	96	467.67500
27	413.13750	62	417.53750	97	467.77500
28	413.15000	63	419.15000	98	468.62500
29	413.16250	64	419.40000	99	469.52500
30	413.17500	65	419.96250	100	469.57500
31	413.18750	66	462.02500	101	469.60000
32	413.20000	67	462.20000	102	469.90000
33	413.21250	68	462.70000	103	471.85000
34	413.25000	69	462.78750	104	507.57500
35	413.26250	70	462.82500		

# UHF-CB Channel Guidelines

---

Always listen on a channel (or observe the receive signal level meter) to ensure it is not already being used before transmitting.

Channels 5 and 35 are used for emergency channels.  
CTCSS and DCS will not operate on these channels.



## NOTE

Please follow these guidelines for channel use in Australia:

- Channels 05 and 35 are Emergency Channels.
- Channel 11 is a Calling Channel.
- Channels 22 and 23 are for telemetry and telecommand applications, channels 61, 62 and 63 are for future use and TX is inhibited on these channels.

General communication is accepted on all other channels with these guidelines:

- Channel 40 - road channel (Australia).
- Channels 01-08 (and 31-38), and Channels 41-48 (and 71-78) are repeater channels.

## Important information - 80 Channel UHF-CB channel expansion

To provide all users additional channel capacity within the UHF-CB Band. The ACMA will change the majority of the current wideband 40 channel use to narrowband channel use. This allows for additional channels to be added, up to 80 Channels.

This simply means that the new narrowband radio you have purchased will have more channels than older radios. Please refer to the guidelines above and the channel chart for further channel information.

A list of currently authorised channels can also be obtained from the ACMA website in Australia and the MBIE website in New Zealand.



## NOTE

### Interference / Poor Audio

When a new narrowband radio receives a signal from an older wideband radio the speech may sound loud - however the radio's built-in AVS (Automatic Volume Stabilizer) circuitry will detect and manage incoming audio to comparable levels.

Narrowband radios operating on CH41 - CH80 may encounter interference from a nearby wideband radios transmitting on high power on an adjacent channel (frequency).

When an older wideband radio receives a signal from a new narrowband radio the speech may sound quiet - the wideband radio user simply adjusts their radio volume for best performance.

The above situations are not a fault of the radio but a symptom of mixed wideband and narrowband radios in current use. It is expected that as older wideband radios are phased out this issue will be eliminated.

# UHF-CB Channels and Frequencies

CH No.	Simplex Mode Transmit / Receive Frequency (MHz)	Duplex Mode Transmit Frequency (MHz)	CH No.	Simplex Mode Transmit / Receive Frequency (MHz)
1	476.425	477.175 (CH31)	21	476.925
2	476.450	477.200 (CH32)	22	476.950 (RX only)
3	476.475	477.225 (CH33)	23	476.975 (RX only)
4	476.500	477.250 (CH34)	24	477.000
5	476.525	477.275 (CH35)	25	477.025
6	476.550	477.300 (CH36)	26	477.050
7	476.575	477.325 (CH37)	27	477.075
8	476.600	477.350 (CH38)	28	477.100
9	476.625		29	477.125
10	476.650		30	477.150
11	476.675		31	477.175
12	476.700		32	477.200
13	476.725		33	477.225
14	476.750		34	477.250
15	476.775		35	477.275
16	476.800		36	477.300
17	476.825		37	477.325
18	476.850		38	477.350
19	476.875		39	477.375
20	476.900		40	477.400

# UHF-CB Channels and Frequencies

CH No.	Simplex Mode Transmit / Receive Frequency (MHz)	Duplex Mode Transmit Frequency (MHz)	CH No.	Simplex Mode Transmit / Receive Frequency (MHz)
41	476.4375	477.1875 (CH 71)	61	future use 476.9375 (RX only)
42	476.4625	477.2125 (CH 72)	62	future use 476.9625 (RX only)
43	476.4875	477.2375 (CH 73)	63	future use 476.9875 (RX only)
44	476.5125	477.2625 (CH 74)	64	477.0125
45	476.5375	477.2875 (CH 75)	65	477.0375
46	476.5625	477.3125 (CH 76)	66	477.0625
47	476.5875	477.3375 (CH 77)	67	477.0875
48	476.6125	477.3625 (CH 78)	68	477.1125
49	476.6375		69	477.1375
50	476.6625		70	477.1625
51	476.6875		71	477.1875
52	476.7125		72	477.2125
53	476.7375		73	477.2375
54	476.7625		74	477.2625
55	476.7875		75	477.2875
56	476.8125		76	477.3125
57	476.8375		77	477.3375
58	476.8625		78	477.3625
59	476.8875		79	477.3875
60	476.9125		80	477.4125



# Warranty

---

## UNIDEN UH9000 UHF CB Transceiver

**IMPORTANT:** Satisfactory evidence of the original purchase is required for warranty service

Please refer to our Uniden website for any details or warranty durations offered in addition to those contained below.

**Warrantor:** The warrantor is Uniden Australia Pty Limited ABN 58 001 865 498 (“Uniden Aust”).

**Terms of Warranty:** Uniden Aust warrants to the original retail purchaser only that the UH9000 UHF CB Transceiver (“the Product”), will be free from defects in materials and craftsmanship for the duration of the warranty period, subject to the limitations and exclusions set out below.

**Warranty period:** This warranty to the original retail purchaser is only valid in the original country of purchase for a Product first purchased either in Australia or New Zealand.

Product	5 Years
Battery Pack & Accessories	1 Years

If a warranty claim is made, this warranty will not apply if the Product is found by Uniden to be:

- (A) Damaged or not maintained in a reasonable manner or as recommended in the relevant Uniden Owner’s Manual;
- (B) Modified, altered or used as part of any conversion kits, subassemblies or any configurations not sold by Uniden Aust;
- (C) Improperly installed contrary to instructions contained in the relevant Owner’s Manual
- (D) Repaired by someone other than an authorized Uniden Repair Agent in relation to a defect or malfunction covered by this warranty; or
- (E) Used in conjunction with any equipment, parts or a system not manufactured by Uniden.

**Parts Covered:** This warranty covers the Product and included accessories.

**User-generated Data:** This warranty does not cover any claimed loss of or damage to user-generated data (including but without limitation phone numbers, addresses and images) that may be stored on your Product.

**Statement of Remedy:** If the Product is found not to conform to this warranty as stated above, the Warrantor, at its discretion, will either repair the defect or replace the Product without any charge for parts or service. This warranty does not include any reimbursement or payment of any consequential damages claimed to arise from a Product’s failure to comply with the warranty.

---

# Warranty

---

Our goods come with guarantees that cannot be excluded under the Australian Consumer Law. You are entitled to a replacement or refund for a major failure and for compensation for any other reasonably foreseeable loss or damage. You are also entitled to have the goods repaired or replaced if the goods fail to be of acceptable quality and the failure does not amount to a major failure.

This warranty is in addition to and sits alongside your rights under either the COMPETITION AND CONSUMER ACT 2010 (Australia) or the CONSUMER GUARANTEES ACT (New Zealand) as the case may be, none of which can be excluded.

**Procedure for obtaining warranty service:** Depending on the country in which the Product was first purchased, if you believe that your Product does not conform with this warranty, you should deliver the Product, together with satisfactory evidence of your original purchase (such as a legible copy of the sales docket) to Uniden. Please refer to the Uniden website for the address details. You should contact Uniden regarding any compensation that may be payable for your expenses incurred in making a warranty claim. Prior to delivery, we recommend that you make a backup copy of any phone numbers, images or other data stored on your Product, in case it is lost or damaged during warranty service.

## **UNIDEN AUSTRALIA PTY LTD**

Phone: 1300 366 895

Email: [custservice@uniden.com.au](mailto:custservice@uniden.com.au)



**THANK YOU FOR BUYING A UNIDEN PRODUCT.**

**Uniden<sup>®</sup>**

© 2016 Uniden Australia Pty Limited. Printed in Vietnam.  
U01UT979ZZA(0)