

Uniden®

UH8060S **Remote Speaker MIC** **UHF CB Transceiver**

For more exciting new products please visit our website:
Australia: www.uniden.com.au

OWNER'S MANUAL

Contents

Introduction	3
Controls & Connectors	4
Indicators	6
Included with your UH8060S Transceiver	7
Connecting the Microphone	8
Mounting the MIC Hanger	9
Operation	12
Turning on the Power	12
Setting the Auto Squelch	13
Monitor	14
Selecting a Channel	14
Programming the Instant Priority Channel	15
Recalling the Instant Channel	15
Transmitting	15
Call Function	15
DUAL Watch	16
Using Repeater Channels	16
Operating the UHF CB Radio in Duplex Mode	17
Scanning	18
Master Scan (MS) Mode	19
Open Scan (OS) Mode	21
Group Scan (GS) Mode	23
Priority Watch	24
Add/Remove Channels from SCAN Memory	24
Selecting the Call tone	25
Busy Channel Lockout	25
Roger Beep	26
CTCSS (Continuous Tone Coded Squelch System)	26
DCS (Digital Coded Squelch)	27
Beep On/Off	27
Backlight	27
LCD Contrast	28
LCD & Key Backlight Colour	28
LCD & Key Backlight Dimmer	29
CTCSS Codes Table	29
DCS Codes Table	30
UHF CB Channel Guidelines	31
UHF CB Channels & Frequencies	32
Warranty	34

Introduction

The Uniden UH8060S is designed to provide you with years of trouble free service. Its rugged components and materials are capable of withstanding harsh environments. Please read this Operating Manual carefully to ensure you gain the optimum performance of the unit.



NOTE

The citizen band radio service is licenced in Australia by ACMA Radio-communications (Citizen Band Radio Stations) Class Licence and in New Zealand by MBIE General User Licence for Citizen Band Radio and operation is subject to conditions contained in those licenses.

Features

- Narrow Band (NB) 80 Channel Radio*
 - Mini Compact Black Box
 - Remote LCD Speaker Microphone (Remote SPK/MIC) and Extension Cable
 - 12V DC Power Input
 - Built-in AVS Circuitry†
 - Transmission Power 5W
 - LCD Display with Backlight
 - LCD Backlight brightness control ("HI", "LO", "Off")
 - Signal Strength/ Power Meter
 - Instant Channel Programming
 - One touch Instant Channel recalling
 - Dual Watch with Instant Channel
 - Duplex Capability*
 - Master Scan
 - Group Scan and Priority Channel Watch
 - Open Scan
 - Scan Channel Memory On/Off separately with Open Scan, Group Scan
 - Channel Select
 - Busy Channel Lock-out Function
 - Roger Beep Function On/Off
 - 5 Different Call Tones
 - 38 Built-in CTCSS (Continuous Tone Coded Squelch System) and 104 additional DCS (Digital Coded Squelch) codes that are user selectable
 - Volume Control
 - 7 LCD & Key Backlight Colours
 - Base Speaker
 - External Speaker Jack
 - Power On/Off Push Switch
 - Front MIC Jack
 - Auto Squelch
 - Under and over voltage alert function
- * Refer to p.31 - p.33 for channel information
- † AVS - Automatic Volume Stabilizer detects and manages incoming audio to comparable levels.

Controls & Connectors

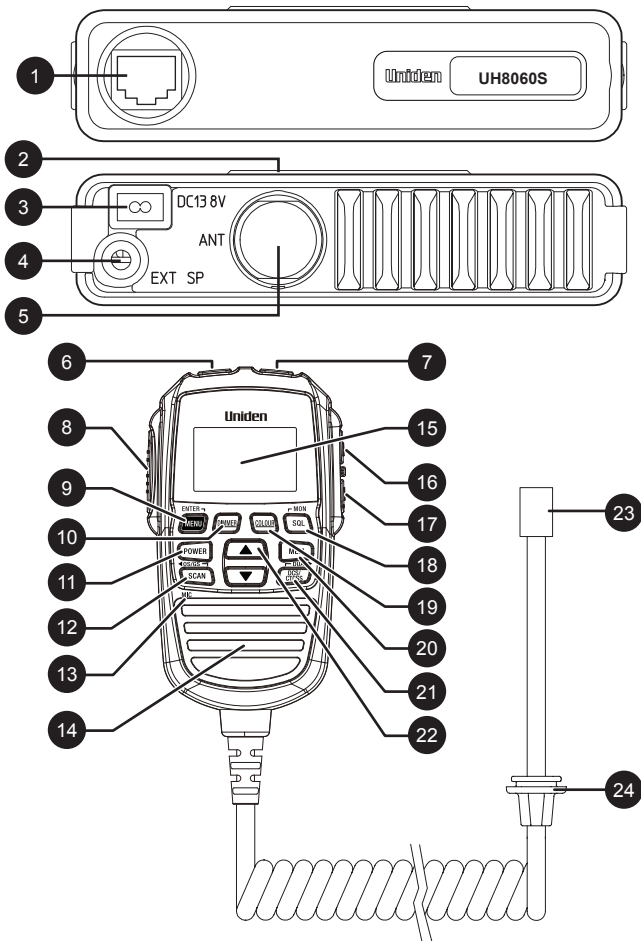





Controls & Connectors

Base (Front & Rear)

- 1 MIC Jack
- 2 Speaker
- 3 Power Input Connection (13.8VDC)
- 4 **EXT SP** - External Speaker Jack
- 5 UHF Antenna Connection

Remote LCD Speaker MIC

- 6 **CALL** - Call Tone Button
- 7 **INST** - Instant Channel Button
- 8 **PTT** - Push To Talk Button
- 9 **MENU** - Menu Button
/ENTER - Enter Button
- 10 **DIMMER** (press & hold)
- 11 **POWER** - Power Button
- 12 **SCAN** - Scan Button
/ OS/GS - Open Scan/
Group Scan
◀ - Move selection left
- 13 MICROPHONE
- 14 SPEAKER
- 15 Liquid Crystal Display (LCD)
- 16 **VOL**  - Volume Up Button
- 17 **VOL**  - Volume Down Button
- 18 **SQL** - Auto Squelch
/MON - Monitor Button
- 19 **COLOUR** (press & hold)
- 20 **MEM** - Memory Scan Channel
- 21 **DCS/CTCSS** - DCS & CTCSS Button
/DUAL - Dual Watch Button
▶ - Move selection right
- 22  /  - Select Up and Down Buttons
- 23 RJ45 type plug
- 24 Front MIC Jack Cover

Indicators

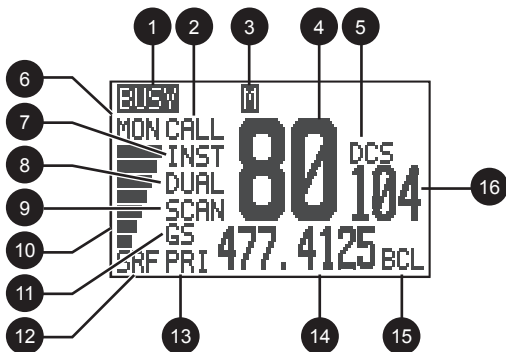

- | | |
|--|---|
| 1 TX/BUSY - Transmit/Busy | 9 SCAN - Scan mode |
| 2 CALL - Call Tone | 10 Signal Power Level |
| 3 M - Channel in Memory | 11 GS - Group Scan |
| 4 Channel Number | 12 S/RF - Receive Signal or Transmit |
| 5 DCS/CTCSS - DCS/CTCSS selected | 13 PRI - Priority Channel Watch |
| 6 MON/SQT - Flashing: Monitor/Tight Squelch | 14 Channel Frequency |
| 7 INST - Instant Channel | 15 BCL - Busy Channel Lockout |
| 8 DUAL - Dual Watch | 16 DCS/CTCSS Code Number |

Included in your UH8060S Transceiver



Remote LCD Speaker
Microphone
(RM800)

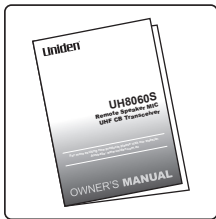

Owner's Manual

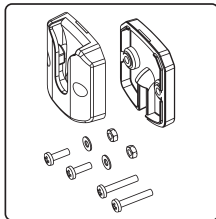

Microphone Hanger
with screws, washers

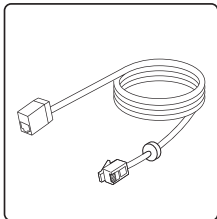

Extension Cable
(EC770)

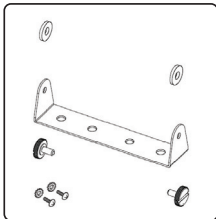

Mounting Bracket with
mounting screws

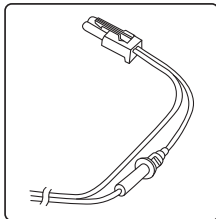

DC Power Cord
with fuse

Optional Accessories:

- UHF Antenna
- External Speaker

Visit the UH8060S page on the website for more information on the availability of optional accessories;

www.uniden.com.au for Australia

Connecting the Microphone

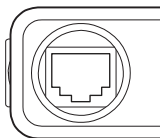

MIC Jack

Before connecting the Microphone Jack decide if you need to use the 2 metre Extension Cable - simply connect the MIC plug into the jack end of the Extension Cable.

Push the MIC plug or Extension Cable plug into the MIC jack of the radio until the connection locks into place. Gently tug the MIC or Extension Cable cord to test that the connection is locked. Use the rubber cover which is on the cord to seal the MIC jack entry from dust.

Disconnecting the MIC from the MIC Jack

Pull back the rubber cover and move it down along the cord. Using the flat blade of a screwdriver or similar object carefully push the lock tab of the MIC plug towards the MIC cord and at the same time tug on the MIC cord to draw back the MIC plug.

Mounting the MIC Hanger

The Microphone Hanger comes in two parts. How and where you mount the MIC hanger will determine which parts to use.

Conventional Mounting with Screws

Use the front part of the MIC Hanger only. Locate a suitable mounting position and mark and drill two 3mm holes. Fix the MIC Hanger into place with screws.

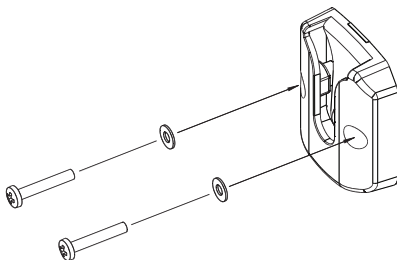

Mounting the MIC Hanger

Conventional Mounting with Double Sided Tape (not supplied)

High quality Double-Sided tape can be found at good retail stores. Secure the front and back pieces of the MIC Hanger using the supplied binding screws.

Locate a suitable mounting position.

Apply high quality Double-Sided tape onto the flat area of the MIC Hanger back piece and then press firmly to the mounting position.

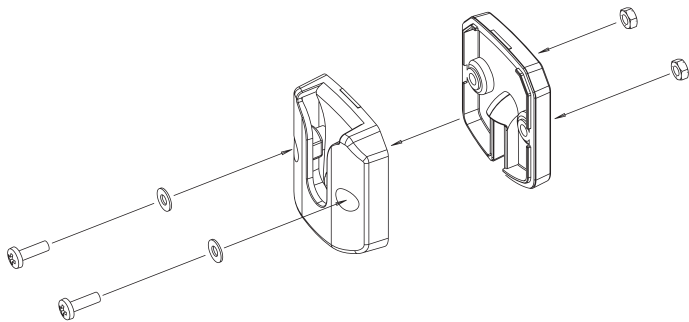

MIC Hanger mounted over MIC Cable



NOTE

The curly cord of the Remote SPK/MIC can extend up to 1.5m. For practical installation of the MIC Hanger mounted over MIC Cable use this method with the Extension Cable.

Mounting the MIC Hanger

Microphone

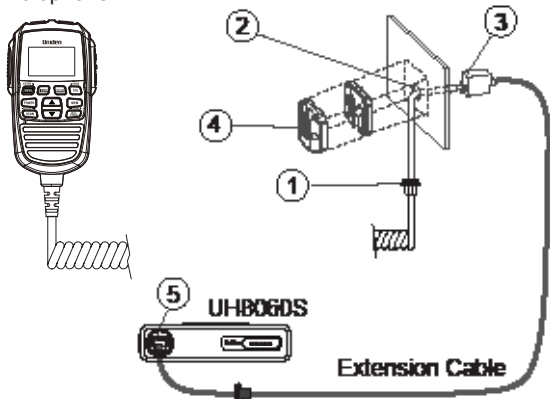

The plug of the extension cable connects to the Radio. The socket end of the extension cable connects with the microphone plug.

1. The rubber collar (dust cover) on the microphone cable is not required and can be cut away or pushed out of the way along the cable.
2. Drill a 13mm hole at the MIC hanger location.
3. Thread the microphone plug through the hole and connect with the extension cable.
4. Mount the MIC Hanger over the hole and cable.
5. At the Radio: Connect the extension cable plug to the MIC Jack. Fit the rubber bushing over the MIC jack.

Operation

Turning on the Power

Press and hold the **[POWER]** button.

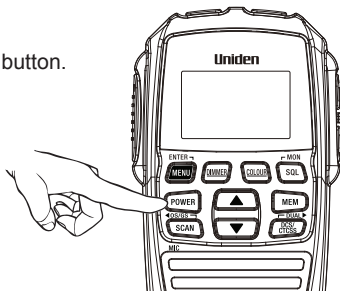

Low-Voltage/High-Voltage Alert

If the power supply voltage exceeds 18VDC, an alert tone sounds and **HI DC** flashes for 5 seconds. The power source must not exceed 25VDC otherwise permanent damage may occur to your radio, which may not be covered by the manufacturer's warranty.



NOTE

If the input voltage falls below 10VDC, **LO DC** flashes for 5 seconds. The power turns off automatically if voltage falls below 8.5VDC.

Switch your UH8060S OFF and disconnect it from the power source, before locating the cause of the power supply problem.

Operation

Setting the Auto Squelch

The Auto Squelch feature has an Off setting and 3 preset squelch levels:

oFF - Squelch open



1 - max sensitivity (min squelch)

2 - med sensitivity (med squelch)

3 - min sensitivity (max/tight squelch)

It requires no adjustment.

1. Press **[SQL/MON]**. The squelch setting flashes.

2. Press  /  to change the setting.
If tight squelch is selected SQT icon
will also flash.

3. Press **[MENU/ENTER]** to
store the setting.

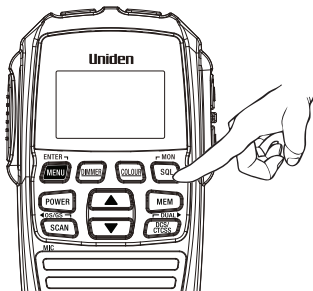

Operation

Monitor

Press and hold [SQL/MON] open the squelch and receive all weak signals. Press and hold [SQL/MON] to cancel.

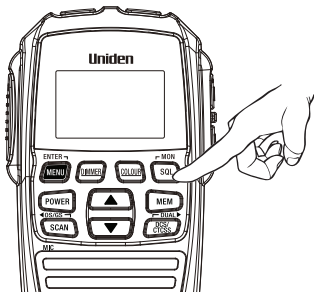

Selecting a Channel

Press ▲ / ▼ to select the desired channel.

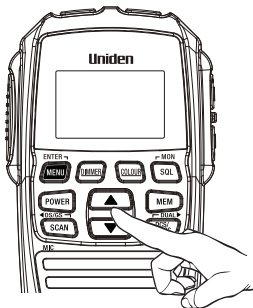



NOTE

For your reference a list of the available channels, corresponding frequencies and guidelines for their use is printed on p.31 - p.33. For Australia, Channels 05 and 35 are reserved for Emergency Calls.

Operation

Programming the Instant Priority Channel

Press  /  to select the Priority Channel you prefer. Press and hold **[INST]** button on the microphone for 2 seconds to store the new setting. INST icon appears.

Recalling the Instant Channel

Momentarily press the **[INST]** button on the microphone at any time to return to the Instant Channel. Press **[INST]** again to return to the previous channel.

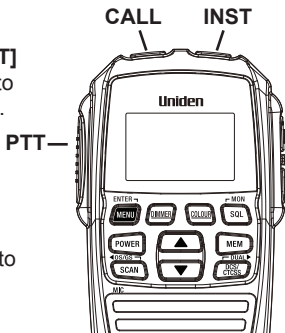

Transmitting

The UHF CB Radio uses UHF-CB Channels.



For your reference a list of the available channels, corresponding frequencies and guidelines for their use and selection is printed on p.31 - p.33. For Australia, Channels 05 and 35 are reserved for Emergency Calls.

Select the desired channel. Press the microphone's **[PTT]** button and speak normally into the microphone. Hold it approx. 7cm from your mouth. Release the **[PTT]** button to end the transmission and listen for a reply.

Call Function

Press the microphone **[CALL]** Button. A three second ringing tone will be transmitted.

You may select from 5 types of tones (see p.25).



Current regulations require calling tones to be restricted to one transmission per minute. If a second transmission is attempted within one minute then an error tone will sound.

Operation

DUAL Watch

Dual watch will continuously monitor the Instant channel no matter what other channel is on (see Programming the Instant Priority Channel above).

Press and hold **[DCS/CTCSS/DUAL]**. DUAL icon appears and a double beep tone is heard.

To cancel DUAL Watch press and hold **[DCS/CTCSS/DUAL]**. DUAL icon disappears.

Using Repeater Channels

UHF CB repeaters are used to retransmit or relay your signal. Repeaters will extend the range of your radio and overcome the shielding effect caused by solid obstructions. In normal Simplex operation, your radio transmits on one particular frequency and receives on that same frequency.

If there is a barrier that partially blocks your transmitted signal, the probability of another radio receiving the signal is very slim. Hills, tall buildings, metallic structures,...etc tend to act as a screen between radios.

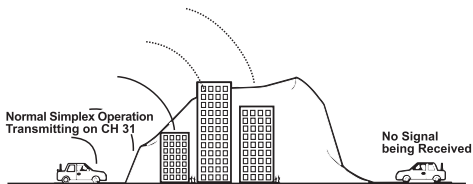

Standard Operation without the aid of a Repeater station.

Operation

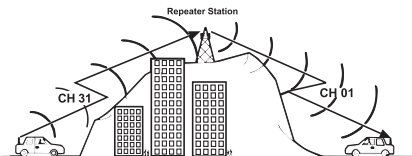

Operation with the aid of a Repeater Station (Duplex).

The signal coming from your radio is received by the Repeater Station and the re-transmitted at the same time on another channel. This operation is called “Duplexing”.

For example,

CH01 on Duplex Mode will Receive on CH01 but Transmit on CH31

CH02 on Duplex Mode will Receive on CH02 but Transmit on CH32

etc...

If you transmit on CH01 Duplex mode, you are actually transmitting on CH31 the repeater station down-converts your signal and retransmits on CH01.

Operating the UHF CB Radio in Duplex Mode

For this example we are adopting CH01 as the channel being used in your area for repeater use.

1. Press **[MENU/ENTER]**. The duplex setting flashes.
2. Press **▲** / **▼** to change the setting between ON (“ r ” for repeater channels 01 - 08 or “ n ” for repeater channels 41 - 48) or OFF (standard channel numbering).
3. Press **[MENU/ENTER]** to store the setting.

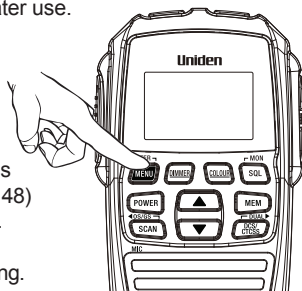

Operation

4. Press and hold **[MENU/ENTER]** to save & exit from the menu mode. Only channels 01 - 08 and 41 - 48 are available for Duplex.



Check with your local Retailer for information on available repeaters.

Scanning

The UH8060S' Scanning feature allows you to search for active channels automatically.

There are 3 scanning modes;

Open Scan (OS),

Group Scan (GS) and

Master Scan (M.SCN) (a special case of Group Scan).



During SCAN the UH8060S' only checks channels or frequencies that are in the SCAN Memory, which are indicated by the M (memory) icon. The UH8060S' maintains two SCAN Memories; one for Open Scan (OS) mode and the other for Group Scan (GS mode, to give you flexibility and allow you to use the radio more effectively.



Group Scan and Master Scan modes share the same SCAN Memory.

1. Press **[SCAN]** to start Scanning.

2. The SCAN icon appears.

3. The scan direction can be changed at any time by pressing  /  on the remote mic.

4. Press **[SCAN]** to stop Scanning.

Operation

Add/Remove Channels from SCAN Memory

Select OS Scanning Mode. Select the channel you want to store.

Press **[MEM]**. MEM icon appears and a beep tone sounds.

To remove the channel from SCAN memory, press **[MEM]** once more.

The MEM icon disappears.

MASTER SCAN Mode

MASTER SCAN is the default scan mode and is enabled to allow continual communication across congested channels.

Master Scan scans channels stored into GS Memory and only opens the squelch for signals with the correct subcode (CTCSS or DCS tone).

To achieve this, all radios in your group must have the same channels in GS memory (group channels) and use the same Subcode (CTCSS or DCS tone).

By scanning only group channels, radios in the network will be able to detect and receive group transmissions- continual communication without interruption. When transmitting in this mode, the radio switches to an unused group channel if it detects another signal with no code, or the wrong code, on the channel last used by the group. In this way, all group users will be able to have continual communication to or from other users.

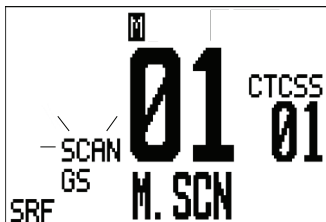

CH09-CH20 are stored into GS Memory and CTCSS01 is set for MASTER SCAN Subcode by default. The GS memory can be changed, channel by channel, if desired - but for Master Scan to work effectively each radio in the group must have the same channels in its GS memory. To add/remove channels from GS SCAN Memory, refer the section above.

Operation



RX only Channels (CH22, CH23, CH61, CH62 and CH63) will not be included in MASTER SCAN Mode even though stored into GS Memory. Also channels for which Duplex Setting are On will be skipped in MASTER SCAN Mode.

To select MASTER SCAN Mode:

1. Press [MENU] two times.
The following scan setting flashes.
2. Press  /  to change the setting.

OS: Scan mode becomes Open Scan

GS: Scan mode becomes Group Scan

PO: Master Scan is ON with the current GS channel memory.

P1: Master Scan is ON with loading CH09-20 in GS.

P2: Master Scan is ON with loading CH21-30, 39, 40 in GS.

P3: Master Scan is ON with loading CH49-60 in GS.

P4: Master Scan is ON with loading CH61-70, 79, 80 in GS.

Operation



3. Press [MENU] one more time.

4. Press  /  to select the desired Subcode (CTCSS or DCS).

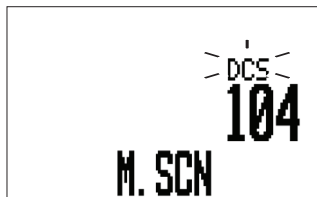
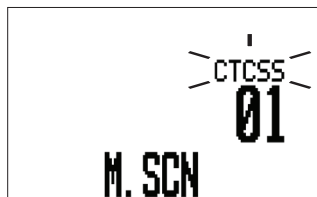

5. Press and hold the [MENU] to save and exit from the Menu Mode.



NOTE

If a button is not pressed within 10 seconds the UHF CB Radio will automatically exit the Menu Mode.

Open Scan (OS) Mode

All UHF-CB channels have been added to the OS SCAN Memory for convenience. To add/remove channels from OS SCAN Memory, refer to p.24.

Allows continuous scanning of all selected channels. If an active channel is found, scanning will stop on that channel. If the received signal ceases, the unit will wait 3 seconds for the signal to return, otherwise scanning resumes.

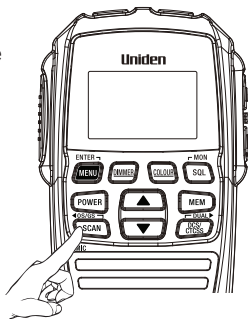

Operation

After transmission in scan mode, the unit will wait 20 seconds for the signal to return, otherwise scanning resumes.

To deactivate SCAN, press **[SCAN]**.



NOTE

If SCAN is deactivated while on an active channel, the UH8060S will stay on that active channel. If no channels are active, the UH8060S will reinstate the starting channel.



NOTE

OS Mode is indicated by the absence of the GS icon.

Operation

Group Scan (GS) Mode

GS Mode has CH09 to CH20 in the SCAN Memory by default. Channels must be stored to the GS SCAN Memory before group scan can start. To add/remove channels from GS SCAN Memory, refer to p.24.

Includes the accessory feature Priority Watch which allows you to monitor the Instant Priority Channel while scanning (see p.15 for setting Instant Priority Channel and p.24 to turn on Priority Watch).

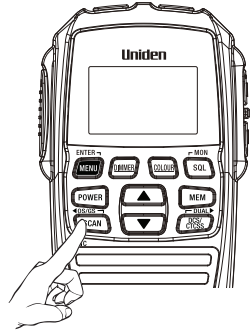

GS Scanning checks the Instant Priority Channel for activity regularly when Priority Watch is ON.

If the Priority Channel becomes active the radio will stay on that channel for as long as the signal is present. If the received signal ceases, Priority Scanning continues after 3 seconds.

If scanning stops on a channel which is not a Priority Channel, UHF CB Radio will continue monitoring the Priority Channel for activity while listening to the active one.

To deactivate SCAN, press **[SCAN]**.





NOTE

If a button is not pressed within 10 seconds the UHF CB Radio will automatically exit the Menu Mode.

Operation

Priority Watch

To switch Priority Watch On/Off;

1. Press **[MENU/ENTER]** four times.
The Priority Watch setting flashes.
2. Press  /  on the Remote SPK/MIC to change the setting between ON or OFF.
3. Press **[MENU/ENTER]** to store the setting.
4. Press and hold **[MENU/ENTER]** to save & exit from the menu mode.

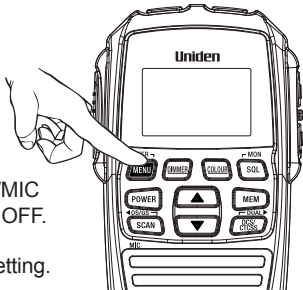

NOTE

If SCAN is deactivated while it is tuned to an active channel, the UHF CB Radio will stay on that active channel. If none of the channels are active, the UHF CB Radio will reinstate the scan start channel.



NOTE

If OS/GS Scanning is initiated when there are no channels programmed in OS/GS memory, an error tone will be heard and scanning will not start (see Programming Scan Channels - below).

Add/Remove Channels from SCAN Memory

Select which Scanning Mode you wish to use - OS or GS. Select the channel you want to store.

Press **[MEM]** to store. MEM icon appears and a short tone beep is heard.

To remove the channel from SCAN memory, press **[MEM]** once more. The MEM icon disappears.

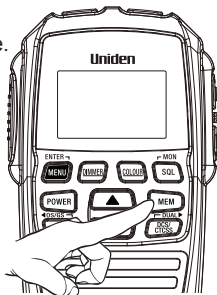

Operation

Selecting the Call tone

1. Press **[MENU/ENTER]** five times.
The call tone setting flashes.
2. Press **▲** / **▼** to change the setting between 1, 2, 3, 4 and 5.
3. Press **[MENU/ENTER]** to store the setting.
4. Press and hold **[MENU/ENTER]** to save & exit from the menu mode.

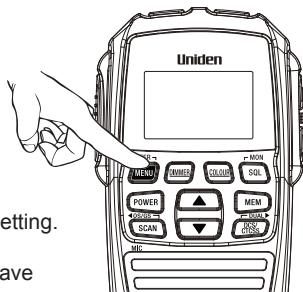

NOTE

If a button is not pressed within 10 seconds the UHF CB Radio will automatically exit the Menu Mode.

Busy Channel Lockout

If the channel is already in use, you can prevent the UHF CB Radio from transmitting. This is particularly important when using CTCSS/DCS.

1. Press **[MENU/ENTER]** six times.
The BCL setting flashes.
2. Press **▲** / **▼** to change the setting between ON or OFF.
3. Press **[MENU/ENTER]** to store the setting.
4. Press and hold **[MENU/ENTER]** to save & exit from the menu mode.

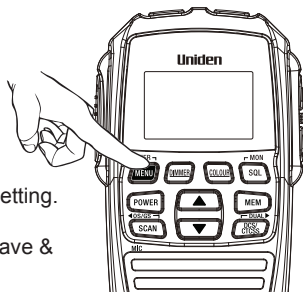

NOTE

If a button is not pressed within 10 seconds the UHF CB Radio will automatically exit the Menu Mode.

Operation

Roger Beep

1. Press **[MENU/ENTER]** seven times.
The roger beep setting flashes.
2. Press **▲** / **▼** to change the setting between ON or OFF.
3. Press **[MENU/ENTER]** to store the setting.
4. Press and hold **[MENU/ENTER]** to save & exit from the menu mode.



NOTE

If a button is not pressed within 10 seconds the UHF CB Radio will automatically exit the Menu Mode.

CTCSS (Continuous Tone Coded Squelch System)

Press **▲** / **▼** the desired channel to use CTCSS.

Press **[DCS/CTCSS]**.

CTCSS icon flashes.

Press **▲** / **▼** on the Remote SPK/MIC to select the desired CTCSS code 01 - 38.
Press **[DCS/CTCSS]** once to store the new setting.

To turn off CTCSS (or DCS) select the OFF code during setting.

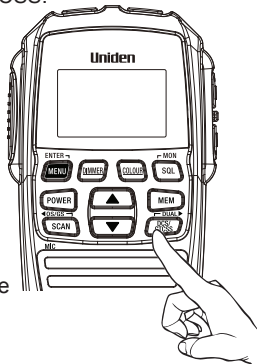

Operation



DCS (Digital Coded Squelch)

DCS is a digital extension of CTCSS. It provides 104 extra, digitally coded, squelch codes that follow after the 38 CTCSS codes. CTCSS 1-38, followed by DCS 1-104.

Follow the steps for setting a CTCSS code. Press  /  until the DCS codes appear.



Press **[DCS/CTCSS]** to set. The DCS icon and code will display.

Beep On/Off

1. Press **[MENU/ENTER]** eight times.
The Beep setting flashes.
2. Press  /  to change the setting between ON or OFF.
3. Press **[MENU/ENTER]** to store the setting.
4. Press and hold **[MENU/ENTER]** to save & exit from the menu mode.



Backlight

1. Press **[MENU/ENTER]** nine times.
The Backlight setting flashes.
2. Press  /  to change the setting between OFF, LO and HI.
3. Press **[MENU/ENTER]** to store the setting.
4. Press and hold **[MENU/ENTER]** to save & exit from the menu mode.



Operation

LCD Contrast

1. Press **[MENU/ENTER]** ten times. The LCD Contrast setting flashes.
2. Press **▲** / **▼** to change the setting between 01 (low contrast) to 10 (high contrast).
3. Press **[MENU/ENTER]** to store the setting.
4. Press and hold **[MENU/ENTER]** to save & exit from the menu mode.

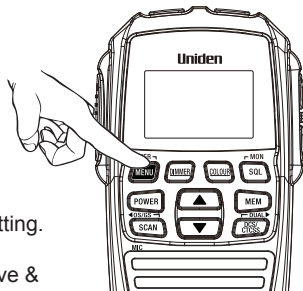

LCD & Key Backlight Colour

1. Press and hold **[COLOUR]**. The LCD backlight will flash.
2. Press **[COLOUR]** while the backlight is flashing to change the setting to a desired colour option. Select from; Clear (White), Blue, Red, Purple, Green, Cyan and Yellow.
3. Press and hold **[COLOUR]** to store the colour setting.

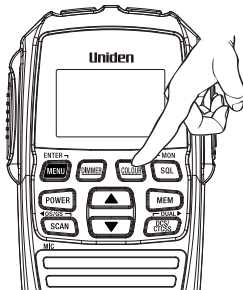

Operation

LCD & Key Backlight Dimmer

1. Press and hold **[DIMMER]**. The LCD backlight will flash.
2. Press **[DIMMER]** while the backlight is flashing to select between 100% or 50% of the Backlight brightness level (Off/Low/High) set in Menu mode.
3. Press and hold **[DIMMER]** to store the dimmer setting.

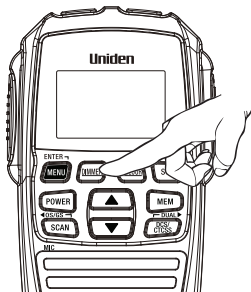

CTCSS codes table

Code No.	Frequency (Hz)	Code No.	Frequency (Hz)
"oF'	OFF	20	131.8
1	67.0	21	136.5
2	71.9	22	141.3
3	74.4	23	146.2
4	77.0	24	151.4
5	79.7	25	156.7
6	82.5	26	162.2
7	85.4	27	167.9
8	88.5	28	173.8
9	91.5	29	179.9
10	94.8	30	186.2
11	97.4	31	192.8
12	100.0	32	203.5
13	103.5	33	210.7
14	107.2	34	218.1
15	110.9	35	225.7
16	114.8	36	233.6
17	118.8	37	241.8
18	123.0	38	250.3
19	127.3		

DCS codes table

Code No.	DCS Code (Octal)	Code No.	DCS Code (Octal)	Code No.	DCS Code (Octal)
1	023	36	223	71	445
2	025	37	225	72	446
3	026	38	226	73	452
4	031	39	243	74	454
5	032	40	244	75	455
6	036	41	245	76	462
7	043	42	246	77	464
8	047	43	251	78	465
9	051	44	252	79	466
10	053	45	255	80	503
11	054	46	261	81	506
12	065	47	263	82	516
13	071	48	265	83	523
14	072	49	266	84	526
15	073	50	271	85	532
16	074	51	274	86	546
17	114	52	306	87	565
18	115	53	311	88	606
19	116	54	315	89	612
20	122	55	325	90	624
21	125	56	331	91	627
22	131	57	332	92	631
23	132	58	343	93	632
24	134	59	346	94	654
25	143	60	351	95	662
26	145	61	356	96	664
27	152	62	364	97	703
28	155	63	365	98	712
29	156	64	371	99	723
30	162	65	411	100	731
31	165	66	412	101	732
32	172	67	413	102	734
33	174	68	423	103	743
34	205	69	431	104	754
35	212	70	432		

UHF CB Channel Guidelines

Always listen on a channel (or observe the receive signal level meter) to ensure it is not already being used before transmitting.

Channels 5 and 35 are used for emergency channels. CTCSS and DCS will not operate on these channels.

Please follow these guidelines for channel use in Australia:

- Channels 05 and 35 are Emergency Channels.
- Channel 11 is a Calling Channel.
- Channels 22 and 23 are for telemetry and telecommand applications, channels 61, 62 and 63 are for future use and TX is inhibited on these channels.



NOTE

General communication is accepted on all other channels with these guidelines:

- Channel 40 - road channel (Australia).
- Channels 01-08 (and 31-38), and Channels 41-48 (and 71-78) are repeater channels.

Important information - 80 Channel UHF CB channel expansion

To provide all users additional channel capacity within the UHF CB Band. The ACMA will change the majority of the current wideband 40 channel use to narrowband channel use. This allows for additional channels to be added, up to 80 Channels.

This simply means that the new narrowband radio you have purchased will have more channels than older radios. Please refer to the guidelines above and the channel chart for further channel information.

A list of currently authorised channels can also be obtained from the ACMA website in Australia and the MBIE website in New Zealand.



NOTE

Interference / Poor Audio

When a new narrowband radio receives a signal from an older wideband radio the speech may sound loud - however the UH8060S' built-in AVS (Automatic Volume Stabilizer) circuitry will detect and manage incoming audio to comparable levels.

Narrowband radios operating on CH41 - CH80 may encounter interference from a nearby wideband radios transmitting on high power on an adjacent channel (frequency).

When an older wideband radio receives a signal from a new narrowband radio the speech may sound quiet - the wideband radio user simply adjusts their radio volume for best performance.

The above situations are not a fault of the radio but a symptom of mixed wideband and narrowband radios in current use. It is expected that as older wideband radios are phased out this issue will be eliminated.

UHF CB Channels & Frequencies

CH No.	Simplex Mode Transmit / Receive Frequency (MHz)	Duplex Mode Transmit Frequency (MHz)	CH No.	Simplex Mode Transmit / Receive Frequency (MHz)
1	476.425	477.175 (CH 31)	21	476.925
2	476.450	477.200 (CH 32)	22	476.950 (RX only)
3	476.475	477.225 (CH 33)	23	476.975 (RX only)
4	476.500	477.250 (CH 34)	24	477.000
5	476.525	477.275 (CH 35)	25	477.025
6	476.550	477.300 (CH 36)	26	477.050
7	476.575	477.325 (CH 37)	27	477.075
8	476.600	477.350 (CH 38)	28	477.100
9	476.625		29	477.125
10	476.650		30	477.150
11	476.675		31	477.175
12	476.700		32	477.200
13	476.725		33	477.225
14	476.750		34	477.250
15	476.775		35	477.275
16	476.800		36	477.300
17	476.825		37	477.325
18	476.850		38	477.350
19	476.875		39	477.375
20	476.900		40	477.400

UHF CB Channels & Frequencies

CH No.	Simplex Mode Transmit / Receive Frequency (MHz)	Duplex Mode Transmit Frequency (MHz)	CH No.	Simplex Mode Transmit / Receive Frequency (MHz)
41	476.4375	477.1875 (CH 71)	61	future use 476.9375 (RX only)
42	476.4625	477.2125 (CH 72)	62	future use 476.9625 (RX only)
43	476.4875	477.2375 (CH 73)	63	future use 476.9875 (RX only)
44	476.5125	477.2625 (CH 74)	64	477.0125
45	476.5375	477.2875 (CH 75)	65	477.0375
46	476.5625	477.3125 (CH 76)	66	477.0625
47	476.5875	477.3375 (CH 77)	67	477.0875
48	476.6125	477.3625 (CH 78)	68	477.1125
49	476.6375		69	477.1375
50	476.6625		70	477.1625
51	476.6875		71	477.1875
52	476.7125		72	477.2125
53	476.7375		73	477.2375
54	476.7625		74	477.2625
55	476.7875		75	477.2875
56	476.8125		76	477.3125
57	476.8375		77	477.3375
58	476.8625		78	477.3625
59	476.8875		79	477.3875
60	476.9125		80	477.4125

Warranty

UNIDEN UH8060S UHF CB Transceiver

IMPORTANT: Satisfactory evidence of the original purchase is required for warranty service

Please refer to our Uniden website for any details or warranty durations offered in addition to those contained below.

Warrantor: The warrantor is Uniden Australia Pty Limited ABN 58 001 865 498 (“Uniden Aust”).

Terms of Warranty: Uniden Aust warrants to the original retail purchaser only that the UH8060S (“the Product”), will be free from defects in materials and craftsmanship for the duration of the warranty period, subject to the limitations and exclusions set out below.

Warranty period: This warranty to the original retail purchaser is only valid in the original country of purchase for a Product first purchased either in Australia or New Zealand.

Product	5 Years
Battery Pack & Accessories	1 Year

If a warranty claim is made, this warranty will not apply if the Product is found by Uniden to be:

- (A) Damaged or not maintained in a reasonable manner or as recommended in the relevant Uniden Owner’s Manual;
- (B) Modified, altered or used as part of any conversion kits, subassemblies or any configurations not sold by Uniden Aust or Uniden NZ;
- (C) Improperly installed contrary to instructions contained in the relevant Owner’s Manual
- (D) Repaired by someone other than an authorized Uniden Repair Agent in relation to a defect or malfunction covered by this warranty; or
- (E) Used in conjunction with any equipment, parts or a system not manufactured by Uniden.

Parts Covered: This warranty covers the Product and included accessories.

Warranty

User-generated Data: This warranty does not cover any claimed loss of or damage to user-generated data (including but without limitation phone numbers, addresses and images) that may be stored on your Product.

Statement of Remedy: If the Product is found not to conform to this warranty as stated above, the Warrantor, at its discretion, will either repair the defect or replace the Product without any charge for parts or service. This warranty does not include any reimbursement or payment of any consequential damages claimed to arise from a Product's failure to comply with the warranty.

Our goods come with guarantees that cannot be excluded under the Australian Consumer Law. You are entitled to a replacement or refund for a major failure and for compensation for any other reasonably foreseeable loss or damage. You are also entitled to have the goods repaired or replaced if the goods fail to be of acceptable quality and the failure does not amount to a major failure.

This warranty is in addition to and sits alongside your rights under either the COMPETITION AND CONSUMER ACT 2010 (Australia) or the CONSUMER GUARANTEES ACT (New Zealand) as the case may be, none of which can be excluded.

Procedure for obtaining warranty service: Depending on the country in which the Product was first purchased, if you believe that your Product does not conform with this warranty, you should deliver the Product, together with satisfactory evidence of your original purchase (such as a legible copy of the sales docket) to Uniden at the address shown below. You should contact Uniden regarding any compensation that may be payable for your expenses incurred in making a warranty claim. Prior to delivery, we recommend that you make a backup copy of any phone numbers, images or other data stored on your Product, in case it is lost or damaged during warranty service.

UNIDEN AUSTRALIA PTY LTD

Service Division
345 Princes Highway,
Rockdale, NSW 2216
Phone: 1300 366 895
Email: custservice@uniden.com.au

THANK YOU FOR BUYING A UNIDEN PRODUCT.

Uniden[®]

© 2014 Uniden Australia Pty Limited. Printed in Vietnam.
U01UT959AZZ(0)