

Uniden®

XDECT SSE35 Series

For more exciting new products please visit our website:

Australia: www.uniden.com.au

New Zealand: www.uniden.co.nz

OWNER'S MANUAL

IMPORTANT SAFETY INSTRUCTIONS

When using your telephone equipment, basic safety precautions should always be followed to reduce the risk of fire, electric shock and injury to persons, including the following:

- **This unit is NOT waterproof.** DO NOT expose this unit to moisture.
- DO NOT expose this unit to rain.
- Do not use this product near water, for example, near a bath tub, wash bowl, kitchen sink or laundry tub, in a wet basement or near a swimming pool.
- Avoid using a telephone (other than a cordless type) during an electrical storm. There may be a remote risk of electric shock from lightning.
- Do not use the telephone to report a gas leak in the vicinity of the leak.
- Use only the power cord and batteries indicated in this manual. Do not dispose of batteries in a fire. They may explode. Check with local codes for possible special disposal instructions.
- Do not place the handset in any charging cradle without the battery installed and the battery cover securely in place.

SAVE THESE INSTRUCTIONS!

Important Notice:

- Under power failure conditions this appliance may not operate. Please ensure that a separate telephone, not dependent on local power, is available for emergency use.

General Notices for New Zealand Model:

- The grant of a NZ Telepermit for any item of terminal equipment indicates only that Telecom has accepted that the item complies with minimum conditions for connection to its network. It indicates no endorsement of the product by Telecom, nor does it provide any sort of warranty. Above all, it provides no assurance that any item will work correctly in all respects with another item of Telepermitted equipment of a different make or model, nor does it imply that any product is compatible with all of Telecom's network services.
- The maximum volume setting of this telephone exceeds the Telecom specified volume requirement. Telecom takes no responsibility for the high volume available on this telephone, who believe this telephone is too loud should contact the manufacturer at the website indicated on owner's manual warranty page.
- For telephone networks other than Telecom there may be a charge incurred for local calls if the Insert 0 feature is on. Turn Insert 0 off.
- This equipment may not provide for the effective hand-over of a call to another device connected to the same line.

WHAT'S IN THE BOX?



SSE35 base with answering system and cordless handset and mounting bracket

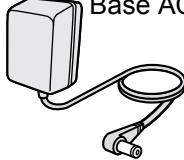

Base AC Adaptor (AAD-041S(M))

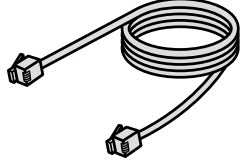

Telephone Cord

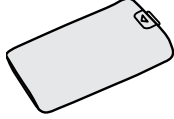

Battery Cover



Belt clip

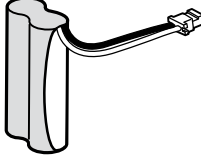

Rechargeable Battery Pack (BT-694, BT-694s or BT-694n)

You might also find:



SSE06 accessory handset and charger



Battery Cover

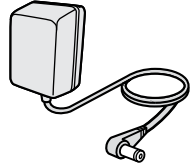

AC Adaptor (AAD-600S(M))



Belt clip

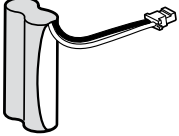

Rechargeable Battery Pack (BT-694, BT-694s or BT-694n)

If you purchased model number:	You should have
SSE35	None
SSE35+1	1 of each
SSE35+2	2 of each
SSE35+3	3 of each
SSE35+4	4 of each
SSE35+5	5 of each

- If any items are missing or damaged, contact your place of purchase immediately. Never use damaged products!
- Need help? Get answers at our website:
www.uniden.com.au for Australian model
www.uniden.co.nz for New Zealand model.

CONTENTS

INSTALLING YOUR PHONE	5
GETTING TO KNOW YOUR PHONE	6
Parts of the Base	6
Parts of the Handset	7
Using the Belt Clip	9
USING THE MENUS	10
Handset Setup Menu	12
Answering Setup Menu	13
Advanced Setup Menu	13
Entering Text on Your Phone	14
USING YOUR PHONE	15
Change the Volume	15
Finding a Lost Handset	15
Using Caller ID and Call Waiting	16
Using the Phonebook	17
Chain Dialing	17
USING SPECIAL FEATURES	18
Adjusting the Base Ringers	18
Using the Audio Boost	18
DND (Do Not Disturb) Mode	18
Using Caller Announce	19
Call Blocking	20
Using Multi-Handset Features	21
Using Voice Message Notification	22
Using an Optional Headset	22
Staying in Range	23
USING THE ANSWERING SYSTEM	24
Answering System Options (Answering Setup)	24
Accessing the Answering System	25
Recording Your Personal Greeting	25
Getting Your Messages	26
Using the System While You're Away from Home	28
IMPORTANT INFORMATION	29
Solving Problems	29
Resetting a Handset	31
Registering a Handset	31
INDEX	33
ONE-YEAR LIMITED WARRANTY	34

INSTALLING YOUR PHONE

Charge the battery

1. Unpack all handsets, battery packs, and battery covers. If you need to remove a cover, press in on the notch and slide the cover down and off.
2. Line up the battery connector with the jack inside the handset; the connector only fits one way.
3. Push the connector in until it clicks into place; tug gently on the wires to make sure the battery is securely connected.
4. Replace the battery cover and slide it into place.
5. Use an AC adaptor to connect the power jack on the base to a regular indoor (240V AC) power outlet. Connect any chargers the same way.
6. Place a handset in the base with the display facing forward. If the battery icon does not begin cycling through levels, reseal the handset or connect the base to a different outlet. For 2 or more handsets, place each handset in a charger.

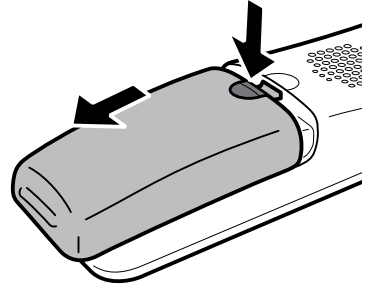

☞ **Charge all handsets completely (about 15 hours) before using.**

Connect the Telephone Cord

Use the telephone cord to connect the TEL LINE jack on the base to a standard telephone wall jack.

Test the Connection

1. Pick up the handset and press **TALK/FLASH**. The handset sounds a dial tone, and the display shows Talk.
 - If you don't hear a dial tone or the display says *Check Tel Line*, check the connection between the base and the phone jack.
2. Make a quick test call. (Press **TALK/FLASH** to hang up.)
 - If there's a lot of noise, check for interference (see page 29).
3. Test all handsets the same way. If you can't get a dial tone, move the handset closer to the base.

GETTING TO KNOW YOUR PHONE

Parts of the Base

Front View

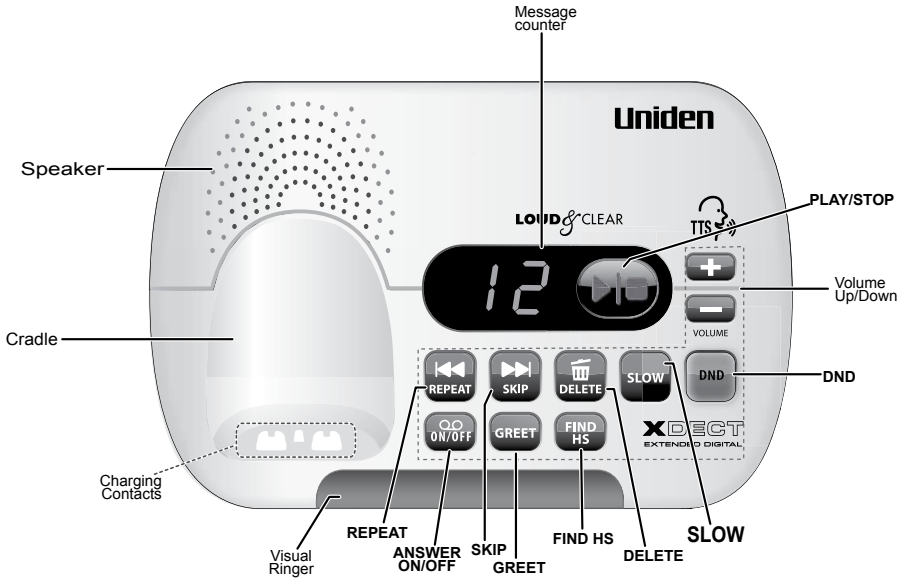

Key Icon	What it does
PLAY/STOP ► ■	<ul style="list-style-type: none"> • In standby: also start playing new messages. • While playing a message: stop playing messages. • While the phone is ringing: ignore this call (mute the ringer).
VOLUME	<ul style="list-style-type: none"> • In standby or while the phone is ringing: increase/decrease the ringer volume. • While playing a message: increase/decrease the speaker volume.
DND	<ul style="list-style-type: none"> • In standby: press and hold to turn DND Mode on or off (see page 18).
SLOW	<ul style="list-style-type: none"> • During message playback: reduce the speed of the answering system playback by 30%.
REPEAT ◀◀	<ul style="list-style-type: none"> • In the first 2 seconds of a message: go to the previous message. • Anytime after that: restart the current message.
ON/OFF ○○	<ul style="list-style-type: none"> • Turn the Answering system on and off.
SKIP ▶▶	<ul style="list-style-type: none"> • While a message is playing: skip to the next message.
GREET	<ul style="list-style-type: none"> • In standby: record a new greeting or switch greetings.
FIND HS	<ul style="list-style-type: none"> • In standby: page all handsets so you can find a lost one. (pg 15)
DELETE ☐	<ul style="list-style-type: none"> • While playing a message: delete this message. • In standby: delete all messages. • While outgoing greeting is playing: Delete the greeting.



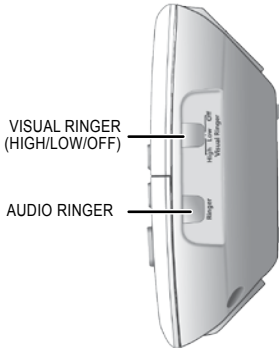

Side View

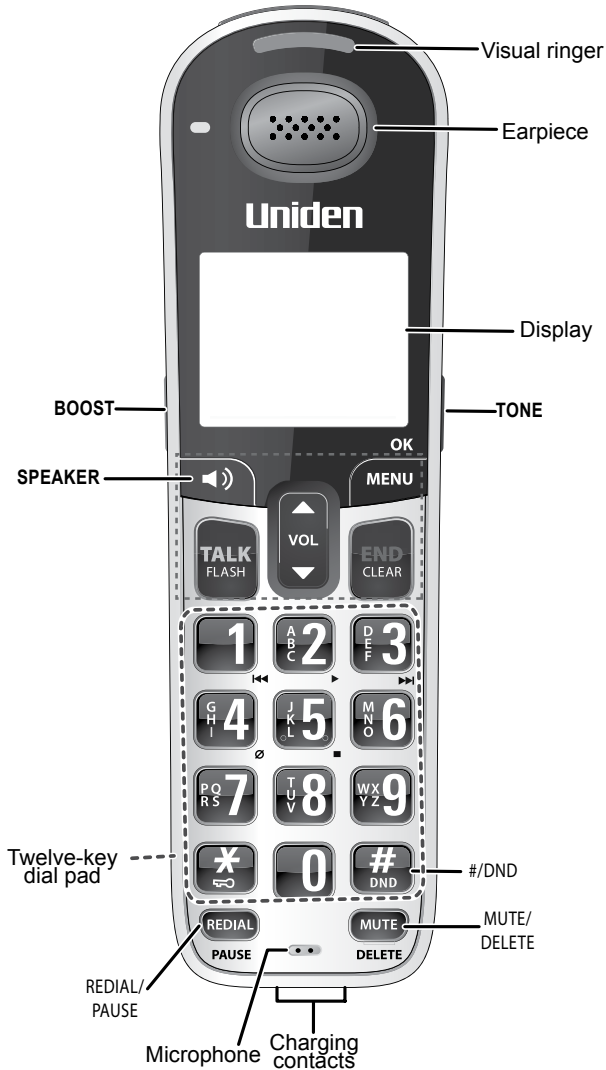

Key Icon	What it does
VISUAL RINGER	<ul style="list-style-type: none"> In standby: adjust the brightness of the base visual ringer (see page 18).
AUDIO RINGER	<ul style="list-style-type: none"> In standby: cycle through 4 different ringer tones and 2 melodies (see page 18).

Parts of the Handset



Key Icon	What it does
TONE	<ul style="list-style-type: none"> • During a call: adjust the audio tone (see page 29).
MENU/OK	<ul style="list-style-type: none"> • In standby: open the menu. • In any menu or list: select the highlighted item.
END/CLEAR	<ul style="list-style-type: none"> • During a call: hang up. • In any menu or list: exit and go back to the previous operation. • While entering text: delete the last character, or press and hold to return to Standby.
#/DND	<ul style="list-style-type: none"> • When entering text: insert a space. • When in standby mode: press and hold for 2 seconds to display the DND Mode menu. See page 18 for details.
MUTE/DELETE	<ul style="list-style-type: none"> • When an incoming call is ringing: mute the ringer. • During a menu operation: delete indicated text or item. • When entering text on your phone: delete text the the left of the cursor. Press and hold to delete the entire entry.
BOOST	<ul style="list-style-type: none"> • During a call: boost the volume of the earpiece (see page 18).
SPEAKER 	<ul style="list-style-type: none"> • In standby: start a telephone call (get a dial tone). • During a call: will return to earpiece speaker. • When screening calls: pick up the call. • In a list: dial the selected number. • When in Hold mode: release Hold.
TALK/FLASH	<ul style="list-style-type: none"> • In standby: start a telephone call (get a dial tone). • During a call: switch to a waiting call.
*/	<ul style="list-style-type: none"> • In text edit mode: changes upper and lower case. • Press and hold to lock keypad
REDIAL/PAUSE	<ul style="list-style-type: none"> • In standby: open the redial list. • During a phone number entry: insert a 3 second pause. • When entering or editing a number into the phonebook: Enter a 3-second pause.
VOL UP 	<ul style="list-style-type: none"> • In standby: increase the ringer volume. • During a call: increase the volume. • In any menu or list: move the cursor up one line.
VOL DOWN 	<ul style="list-style-type: none"> • In standby: decrease the ringer volume. • During a call: decrease the volume. • In any menu or list: move the cursor down one line.

Reading the Display

The table below shows some of the possible icons and what they mean. Since the icons appear based on what you're doing with the phone, you won't ever see all of these icons at the same time.

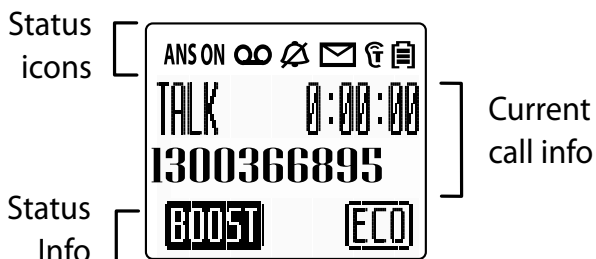

Icon	What it means
	<ul style="list-style-type: none"> The volume of the earpiece is boosted (see page 18).
	<ul style="list-style-type: none"> The ringer is turned off: this handset will not ring when a call comes in.
	<ul style="list-style-type: none"> You have a voice message waiting (see page 22).
	<ul style="list-style-type: none"> Privacy Mode is on: no other handset can use the line or join your call.
	<ul style="list-style-type: none"> The speakerphone is on.
	<ul style="list-style-type: none"> The battery is 1) fully charged, 2) half charged, 3) getting low, or 4) empty.
	<ul style="list-style-type: none"> T-coil mode is on.
ANS ON	<ul style="list-style-type: none"> Answering system status.
	<ul style="list-style-type: none"> Energy saving mode is on (transmission power reduced).

Using the Belt Clip

To attach the belt clip

1. Line up the holes on each side of the handset.
2. Insert the belt clip into the holes on each side of the handset.
3. Press down until it clicks.

To remove the belt clip

Pull either side of the belt clip to release the tabs from the holes.

USING THE MENU

Your phone displays different menus depending on whether you are on-hook or off-hook. Off-hook menus are *Hold/Transfer*, *Recent Calls*, *Phonebook*, and *Call Privacy*. *Hold/Transfer* and *Call Privacy* are unique to off-hook menus but *Recent Calls* and *Phonebook* are common to both off-hook and on-hook menus



To open the menu, press MENU/OK on the handset.

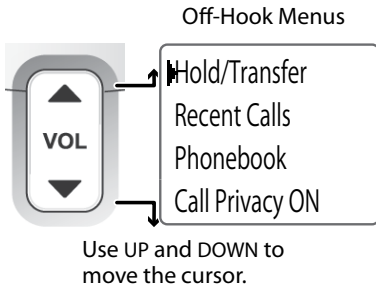

To select the highlighted option, press MENU/OK.

OR

To close the menu, press END/CLEAR.

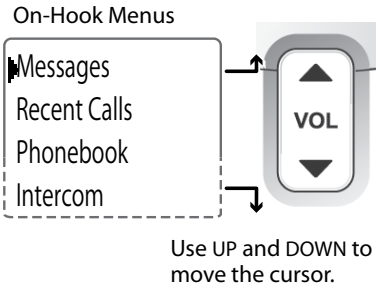

- The phone exits the menu after 30 seconds if no keys are pressed.
- Press **END/CLEAR** during a call to back out of a menu without hanging up.

Hold/Transfer Menu (Off-Hook Menu Only)

This menu option only displays when you are off-hook or on a call and you press **MENU/OK**. Hold/Transfer lets you page a specific handset or transfer the call to or page the all the handsets.

Call Privacy Menu (Off-Hook Menu Only)

This menu lets you turn Call Privacy on and off. With Call Privacy turned on, no other handsets can connect with your conversation. Going on-hook (ending your conversation) resets Call Privacy to off.

Messages Menu

Press **MENU/OK** and select *Messages*. You can select *Play Message* (from your answering system) or *Voice Mail* (from your provider's voice mail service).

Answering System Messages

When you select *Play Messages* from the Messages menu, the system announces the number of incoming messages stored and begins playing them back. See page 24 for details.

Voice Mail Messages

When you select *Voice Mail* from the Messages menu, the system automatically dials the voice mail access number you entered. If you have not set one up, then the Voice Mail Dial Register screen displays. You can enter or edit this number through Advanced Setup/Edit Voice Mail, also.

Recent Calls Menu

The Recent Calls menu lets you view the Caller ID list (up to 50) or the Redial list, a list of the last 10 calls made from that handset.

Phonebook Menu

When you select Phonebook from the menus, the system displays the total number of phonebook listings. Press **MENU/OK** for the following options.

Menu Option	What it does
<i>View Number</i>	<ul style="list-style-type: none">• Displays the phonebook entries in alphabetical order (see page 17).
<i>Create New</i>	<ul style="list-style-type: none">• Create a new phonebook entry (see page 17).
<i>Delete All</i>	<ul style="list-style-type: none">• Delete all entries in the phonebook (see page 17).

Intercom Menu

The Intercom feature allows 2-way communication between handsets only. For more information, see page 22.

Menu Option	What it does
<i>All</i>	<ul style="list-style-type: none">• Pages all handsets.
<i>Handset</i>	<ul style="list-style-type: none">• Lists the handsets available for paging.

Handset Setup Menu

You can change these settings separately for each handset.

Menu Option	What it does
<i>T-coil</i>	Turn on T-coil mode to reduce noise on hearing aids equipped with a telecoil (T-coil) feature. T-coil mode shortens talk time, so keep your battery fully charged.
<i>Ringer Tones</i>	Choose this handset's ring tone. As you highlight each ring tone, you hear a sample. To confirm, press MENU/OK .
<i>Personal Ring</i>	Turn on personal ring so you can assign a special ring tone to people in your phonebook. With Caller ID, this handset uses the assigned tone when the person calls.
<i>Auto Talk</i>	Have this handset answer a call when you pick it up from the cradle (without pressing any keys).
<i>Any Key Answer</i>	Have this handset answer a call when you press any key on the 12-key dialpad.
<i>Banner</i>	Change the name used on the handset's display.
<i>Key Touch Tone</i>	Have your keypad sound a tone when you press a key.
<i>LCD Contrast</i>	Choose the contrast of the display from ten different levels.
<i>Caller Announce</i>	Turn on the Text-To-Speech (TTS) feature (see page 19).

Answering Setup Menu

Refer to page 24 for details on setting up your answering system.

Date & Time Setting

You need to set the clock so messages get the correct time stamp. Setting the date and time on the base or any handset will set it on all handsets/bases.

When you select Date & Time, the system displays the date and time with the first digit of the date flashing. Use the 0 - 9 keys to enter the date and time. When you enter a number, the curser moves to the next position. Press **VOL UP** to move to the the previous position or **VOL DOWN** to accept the current entry and move to the next position. Press **MENU/OK** to accept the date and time you just entered.

Advanced Setup Menu

The settings on this menu affect all the handsets and the base. Only one handset at a time can change these settings.

Menu Option	What it does
<i>Set Line Mode</i>	Do not change this setting unless instructed to by customer service.
<i>VMWI Reset</i>	Reset the Visual Message Waiting Indicator (see page 22).
<i>Edit Voice Mail</i>	Edit your voice mail access number (see page 10).
<i>Time Adjustment</i>	Select Set by Caller ID to allow phone network to automatically set cordless phone system time.
<i>Insert 0</i>	This feature adds "0" or "00" at the beginning of the number received from Caller ID. The default setting for New Zealand is <i>On</i> . The default setting for Australia is <i>Off</i> .

Call Blocking Menu

See page 20 for a detailed description of the Call Blocking feature.

Entering Text on Your Phone

Use the 12-key dial pad anytime you want to enter text into your phone (a name in the phonebook, the handset banner, etc.).

To...	Press...	To...	Press...
Move the cursor left	UP	move the cursor right	DOWN
erase the character at the cursor	MUTE/DELETE*	erase the entire entry	and hold MUTE/DELETE.
switch between upper and lower case letters	*/TONE	enter a blank space	#DND
		enter a symbol	0 repeatedly.

* **MUTE/DELETE** on the handset **CLEAR/MUTE** on the base.

USING YOUR PHONE

To...	Earpiece	Speaker
make a call, dial the number, then	Press TALK/FLASH .	Press SPEAKER .
answer a call	Press TALK/FLASH .	Press SPEAKER .
hang up	Press END/CLEAR or place the handset in the cradle.	
ignore the call (mute the ringer)	Press MUTE/DELETE or END/CLEAR while the phone is ringing.	
switch to/from the speaker	Press SPEAKER .	
mute the microphone	Press MUTE/DELETE .	
	Press again to turn the microphone back on.	
put a call on hold	Press MENU/OK , then select <i>Hold/Transfer</i> .	
return to a call on hold	Press TALK/FLASH .	Press SPEAKER .

- After 2 minutes 50 seconds on hold, the call will be disconnected.

Change the Volume

To Change the...	When...	Press...
earpiece volume for each handset	you are listening to that earpiece or speaker (playing messages, etc.)	UP to increase the volume. DOWN to decrease it.
speaker volume		
ringer volume	the phone is in standby	

- 🔇 if you turn the ringer all the way down, that particular ringer turns off.
- 🔇 If you want to change the volume of Caller ID announcements, change the ringer volume.

Finding a Lost Handset

With the phone in standby, press **FIND** on the base. All handsets beep for 1 minute; to cancel, press **FIND** again or press any handset key.

Using Caller ID and Call Waiting

Caller ID (CID) is a service available from your telephone provider that shows the phone number (and sometimes the caller's name) of the incoming calls; if you turned on Text-To-Speech, it also announces the name. Contact your telephone provider for more information.

Caller ID List	Redial List
<ul style="list-style-type: none">• The phone saves the information for the last 50 received calls to the CID list. An asterisk (*) marks any calls received since the last time you checked the list.• In standby, all handsets show how many calls came in since the last time you checked the CID list.	<ul style="list-style-type: none">• Each handset remembers the last 10 numbers you dialed on it.

To...	Press...
open the CID list	MENU/OK and select <i>Recent Calls/Redial</i> .
open the redial list	REDIAL/PAUSE .
scroll through the lists	DOWN to scroll from newest to oldest. UP to scroll from oldest to newest.
dial the current number	TALK/FLASH or SPEAKER .
delete the current number	MENU/OK , then select <i>Delete Entry</i> .
add the current number to this handset's phonebook.	MENU/OK , then select <i>Store Into Pb</i> . The phone displays the Edit Name screen (see page 17).

Once you display a CID or redial entry, you can delete it or add it to a phonebook.

You can also add CID entries to a call block list, or delete all of them.

Deleting All Numbers in the CID List on This Handset

With the phone in standby, open the CID list. Press **MENU/OK** and select *Delete All*. When the phone prompts you to confirm, select Yes.

Using Call Waiting

If you get a Call Waiting call, the phone can sound a tone and display any CID information received for the waiting call.

For Australia:

Press **TALK/FLASH** and then press 2 to accept the waiting call. The first caller is put on hold, and you will hear the new caller after a short pause. To return to the original caller, press **TALK/FLASH** and then 2 again.

For New Zealand:

Press **TALK/FLASH** to accept the waiting call. The first caller is put on hold, and you will hear the new caller after a short pause. To return to the original caller, press **TALK/FLASH** again.

Using the Phonebook

The base can store up to 200 entries in its phonebook. All handsets share the same phonebook, so only one handset can access it at a time.

To...	Press...
open/close the phonebook	Press MENU/OK and select <i>Phonebook</i> and press MENU
scroll through the entries	DOWN to scroll through the entries from A to Z. UP to scroll from Z to A.
jump to entries that start with a certain letter	the number key corresponding to the letter you want.
dial the current entry	TALK/FLASH or SPEAKER .
edit the current entry	MENU/OK , then select <i>Edit</i> .
delete the current entry	MENU/OK , then select <i>Delete</i> . To confirm, select <i>Yes</i> .

Adding/Editing Phonebook Entries

To add a new phonebook entry (with the phone in standby), open the phonebook. Press **MENU/OK** and select *Create New*. Enter a name and number, then select a personal ring.

To add the current number to the phonebook, press **MENU/OK** and select *Store into Pb*. The *Edit Name* screen displays. Edit the information.

- Enter the phone number (up to 32 digits) exactly as you would dial it.
- If you need to enter a pause between the numbers, press **REDIAL/PAUSE**; you'll see **P** in the display. (The dialing will pause for about 3 seconds per a digit.)
- To edit the number, press **END/CLEAR** or **MUTE/DELETE** to back up the cursor and delete numbers. Re-enter the correct numbers.

Deleting All the Phonebook Entries

With the phone in standby, open the phonebook. Press **MENU/OK**. Select *Delete All*. To confirm, select *Yes*.

Chain Dialing

If you often have to enter a series of digits or a code number during a call, you can save that code number as a regular phonebook entry and use the phonebook to send the code number.

1. Make your call normally. When you hear the prompt that asks you to enter your code number, open the phonebook and find the entry.
2. Press **MENU/OK** to send the code. If you change your mind, just close the phonebook.

USING SPECIAL FEATURES

Adjusting the Base Ringers

Visual Ringer

The visual ringer blinks for the following conditions:

- Incoming call - outside line
- Incoming call - page

You can change the brightness of the base visual ringer. The **VISUAL RINGER** switch is on the right-hand side of the base. Slide the switch to HIGH, LOW, or OFF. (It doesn't affect the audio ringers.)

Audio Ringer

The **RINGER** key is also on the right-hand side of the base. Each time you press the key, it will cycle through 4 ringer tones and 2 melodies.

Using the Audio Boost

You can increase the earpiece volume for normal calls and intercom calls. During a call, press **BOOST**. Press **BOOST** again to turn it off.

DND (Do Not Disturb) Mode

- You can silence the ringers on the base and all handsets at the same time. It doesn't affect the visual ringers.
- With the phone in standby, press and hold **DND** on the base. The phone automatically turns on the answering system and shows DND Mode On in the display on each handset. (The answering system answers any incoming calls without playing anything through the speaker.)
- You can also press and hold ***/DND** on the handset. The DND Mode menu displays. You can choose to have DND mode always on or select a duration from 1 - 9 hours.
- To cancel, press **DND** or ***/DND** again.

 **If you turn the answering system off while DND mode is on, the phone turns off DND mode.**

Using Caller Announce

With the Caller Announce feature, you can turn on Text To Speech so your phone can announce names in different situations.

- You have to turn on Caller Announce separately for each handset (see page 12).
- To change the volume of CID announcements, change the ringer volume. To change the volume for all Caller Announce features, change the speaker volume.
- To make sure it doesn't interrupt a call or an intercom page, the phone only uses Caller Announce when it starts out in standby.
- It takes at least 2 rings for the phone to receive CID information and announce it. If the phone is answered before the end of the second ring, the phone won't announce the name of the caller.

Setting Caller Announce

1. Press **MENU/OK** and scroll to Handset Setup. Press **MENU/OK** to select it.
2. Scroll to *Caller Announce*; press **MENU/OK** to select it.
3. Select *On* or *Off* and then press **MENU/OK** to select it

Call Blocking

If you subscribe to Caller ID, you can save phone numbers to the call block list. When a call comes in, the phone compares the received phone number to the numbers on the call block list. If the phone number is on the list, the phone replaces the caller's name with *Call Blocked* and blocks the call.

The call block list holds 20 entries, and all handsets share the same list. You can add entries by selecting *Add Call Block* in the CID menu that displays after you have viewed the CID record or through the *Call Blocking menu* (see below). (Only one handset can edit the call block list at a time.)

Call Blocking Menu Options

With the phone in standby, open the menu and select *Call Blocking*. Choose one of these options:

Menu Options	What it does
<i>View Number</i>	See the numbers on your call block list.
<i>Create New</i>	Add an entry to your call block list. The phone will prompt you to enter a name & phone number.
<i>Private Number</i>	Block all calls from numbers reported by CID as "Private." (This does not count as one of the 20 entries.)
<i>Unknown Number</i>	Block all calls from numbers reported by CID as "Unknown." (This does not count as one of the 20 entries.)

Call Blocking Menu Options

With the phone in standby, open the menu, select *Call Blocking* then *View Number*; scroll through the entries. Press **MENU/OK** to open the individual entry. Choose one of these options:

Choose this...	To...
<i>Edit</i>	Edit this entry. The phone will prompt you to edit the name & phone number.
<i>Delete</i>	Erase this entry from the list & allow calls from this number.

Blocking a Number

With the phone in standby, open the menu, select *Call Blocking*, then *Create New*. Enter the name and number to be blocked. Press **MENU/OK** to save the entry

Using Multi-Handset Features

✎ To use the features in this section, you need at least 2 handsets.

Expanding Your Phone

- Your base supports a total of 6 cordless handsets, including any that came with your phone.
- You must register accessory handsets to the base before using them. Handsets that aren't registered display a "not registered" message. For registration instructions, see page 31 or the accessory handset manual.

Using Conference Calling

- When an outside call comes in, two handsets can join in a conference call with the outside caller.
- To join the call, just press **TALK/FLASH**. To leave the conference call, hang up normally; the other handset remains connected to the call.

Using Privacy Mode

- To activate Privacy Mode on a call in progress, press **MENU/OK**, select *Call Privacy Off* and press **MENU/OK**. As long as privacy mode is on, no other handsets can join your call.
- Privacy Mode turns off automatically when you hang up or put the call on hold; to turn it off press **MENU/OK**, select *Call Privacy On* and press **MENU/OK**.

Call Transfer

To...	Press...
<i>transfer a call</i>	<ol style="list-style-type: none">1. Select <i>Hold/Transfer</i> from the menus.2. The system puts the call on hold. Select the handset you want to page, or <i>All</i> to page all handsets. <p>When the other handset accepts the call, you'll be disconnected, but you can join the call again.</p>
<i>cancel a transfer</i>	TALK/FLASH to return to the call.
<i>accept a transferred call</i>	TALK/FLASH to answer the page and speak to the other handset. Then, press TALK/FLASH to speak to the caller.

Intercom

- Whenever the phone is in standby, you can make an intercom call between handsets without using the phone line.
- You can make an intercom call from any handset, but only two handsets can be in an intercom call at any time.
- If an outside call comes in during an intercom page, the phone cancels the page so you can answer the incoming call.
- If an outside call comes in during an intercom call, press **TALK/FLASH** to hang up the intercom call and answer the outside call.

To...	Press...
<i>make an intercom page</i>	Select <i>Hold/Transfer</i> from the menu. Select the station you want to talk with, or <i>All to page</i> all stations. When another handset accepts the page, you will be in an intercom call.
<i>cancel a page</i>	END/CLEAR.
<i>answer an intercom page</i>	TALK/FLASH.
<i>leave an intercom call</i>	END/CLEAR. Both handsets return to standby.

Using Voice Message Notification

- If you subscribe to a voice mail service, your phone can notify you when you have a new message. This feature supports Frequency-Shift Keying (FSK) notification. The voice mail service provided by your service provider is independent from the built in answer machine of the SSE35. Contact your voice mail provider for information.
- When you have new messages, the display shows a message icon. Press **MENU/OK** and select *Messages* and select *Voicemail*. The system dials the voice mail access number and then plays your messages. After you listen to your messages, the message icon turns off. If it doesn't, you can reset it from the Advanced Setup/VMWI Reset menu.

Using an Optional Headset

You can use a standard telephone headset (2.5mm diameter jack) with your handsets.

To purchase headsets, visit our website;

www.uniden.com.au for Australia or

www.uniden.co.nz for New Zealand.

- To install a headset, remove the headset jack cover and insert the headset plug into the jack.
- Just make and receive calls as usual, and use your headset to talk to the caller after the call connects.
- While you connect a headset, the handset automatically mutes the earpiece.

Staying in Range

Your system will alert you when you are out of range (or about to go out of range).

If...	Then...
the handset and base are connected (intercom call) and no signal from the base	the handset sounds an error tone and <i>unavailable at this time</i> displays.
the handset is in Talk mode and moves out of range	the outside line is put on Hold for 30 seconds and then dropped. The LCD alternately displays <i>End of Range</i> and a prompt message displays “ <i>Move towards Base</i> ”.
the handset and base are in standby mode and the handset does not get a signal from the base for 15 seconds	the LCD alternately displays <i>Out of Range</i> and <i>Check Base Power</i> .
audio deteriorates	the handset sounds an error tone. The LCD alternately displays <i>End of Range</i> and <i>Move toward base</i> .
you are trying to go off-hook	An error tone sounds. The LCD alternately displays <i>Out of Range</i> and <i>Check Base Power</i> .

USING THE ANSWERING SYSTEM

Answering System Options (Answering Setup)

You can change the answering system options from any handset. Just open the menu and select *Answering Setup*.

Menu Options	What it does
<i>Security Code</i>	Enter a 2-digit PIN so you can access your answering system from any touch-tone phone (see page 28).
<i>Ring Time</i>	Set the number of rings (6, 9, or 12) before the system answers (see page 28 about Toll Saver).
<i>Record Time</i>	Set the amount of time (1 or 4 minutes) callers can leave a message. Choose <i>Announce Only</i> if you don't want the system to let callers leave a message.
<i>Message Alert</i>	Have the base beep every 15 seconds when you have a new message. The alert stops after you listen to all your new messages or if you press any key on the base.
<i>Call Screen</i>	Turn on the call screen feature so you can hear callers as they leave messages on the base speaker (see page 27).
<i>Answer On/Off</i>	Turn your answering system on or off. (To turn your system on or off from the base, just press ON/OFF .)
<i>Record Greeting</i>	Record an outgoing message or greeting (see page 25).
<i>Greeting Options</i>	Switch greetings or delete your greeting (see page 26).

Accessing the Answering System

With the phone in standby, you can access your system from the base or remotely from any handset. Only 1 handset or the base can access the system at a time.

During remote access;

- The system beeps so you know it's waiting for your next command.
- You can press the number key shown next to each command instead of scrolling through the screens.

1. Press **MENU/OK** and select *Messages/Play Message* to listen to your answering system messages. The LCD displays CID information for the current message.
2. The LCD also displays actions you can take while the message is playing. Press the number on the keypad that corresponds to the action you want to take. If you stop the message, the LCD displays *2:Play* instead of *5:Stop*.

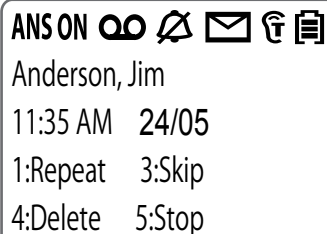

Recording Your Personal Greeting

Your personal outgoing message or greeting can be between 2 seconds and 30 seconds long. If you don't want to record a greeting, the system uses the pre-recorded greeting: Hello, no one is available to take your call. Please leave a message after the tone.

From the Base	From a Handset
<ol style="list-style-type: none"> 1. Press and hold GREET until the system says "Record greeting" (about two seconds). 2. Wait until the system beeps, then begin speaking. 3. Press GREET to stop recording. The system plays back your new greeting. 4. To keep this greeting, do nothing. To re-record it, go back to step 1. 	<ol style="list-style-type: none"> 1. Access the <i>Answering Setup</i> menu and select <i>Record Greeting</i>. 2. Press MENU/OK, a message displays, <i>To Start, Press Ok</i>. Press MENU/OK. Wait until the system prompts "Record greeting" before speaking. 3. Press MENU/OK to stop recording. The system plays back your new greeting. 4. To keep this greeting, press END/CLEAR. To re-record it, go back to step 2.

Switch Between Greetings

From the Base	From a Handset
<ol style="list-style-type: none"> 1. Press GREET. The system plays back the greeting it is currently using. 2. Press GREET. again to switch greetings. 	<ol style="list-style-type: none"> 1. Press MENU/OK and select <i>Answering Setup/Greeting Options</i>. 2. The current outgoing message plays. 3. During playback, press MENU/OK to switch between the preset outgoing message and the message you created.

Delete Your Greeting

From the handset, switch to your personal greeting; while it is playing back, press **MUTE/DELETE**. The system announces “*Greeting has been deleted*” and displays Deleted!

From the base, press and hold the **GREET** button until the system plays the greeting. Then as the greeting is being played, press **DELETE** button to delete it.

Getting Your Messages

To..	From the Base	From the Handset
play new messages	Press PLAY/STOP .	Press MENU/OK , then select <i>Messages/Play Messages</i> .
	The system announces the number of new and old messages, then plays each new message (followed by the day and time if set) in the order it was received.	
restart this message	Wait at least 5 seconds after the message starts playing,	
	Press BACK .	Select 1: <i>Repeat</i> .
replay an earlier messages	Within 2 seconds after a message starts playing,	
	Press BACK .	Select 1: <i>Repeat</i> .
skip a message	Press SKIP .	Select 3: <i>Skip</i> .
slow down message playback	Press SLOW . Press again to return to normal playback speed.	Not available.
delete a message	While the message is playing,	
	press DELETE .	select 4: <i>Delete</i>
delete all messages	With the phone in standby, press DELETE ; press DELETE again to confirm.	Not available.
play old messages	After the system plays the new messages,	
	press PLAY/STOP again.	select 2: <i>Play</i> .
stop playback	Press PLAY/STOP .	Select 5: <i>Stop</i> .

Screening Your Calls

You can use the answering system for call screening. While the system takes a message, you can listen on the base speaker (if you turn on Call Screen) or from a handset. Only one handset can screen calls at a time. If another handset tries to screen the call, error tone will sound, “*Unavailable at this time*” will be displayed and returns to standby.

To...	From the Base	From the Handset
turn on Call Screen	Not Available.	Press MENU/OK then select Answering Setup/Call Screen menu. Turn call screen on or off.
hear the caller leaving a message	Just listen to the caller over the speaker.	Press MENU/OK .
answer the call	Not available	Press TALK/FLASH .
mute the call screen without answering	Press PLAY/STOP .	Press END/CLEAR or return the handset to the cradle.

 **If you mute the call screen, the system continues taking the message: it just stops playing through the speaker.**

Using the System While You're Away from Home

You can also operate your answering system from any touch-tone phone. Before you can use this feature, you have to program a security code.

Programming a Security Code

With the phone in standby, open the menu. Select *Answering Setup*, then select *Security Code*. Use the number keypad to enter a two-digit security code (01 to 99). Press **MENU/OK** when you're finished.

🔔 **Remember to make a note of your new security code!**

Dialing in to Your System

1. Call your telephone number and wait for the system to answer.
 - If you have the Ring Time set to Toll Saver, the system answers after 2 rings if you have new messages and 4 rings if you don't. You can hang up during the third ring.
 - If your answering system is off, it will answer after about 15 rings and sound a series of beeps instead of your greeting.
2. During the greeting (or beeps), press # and immediately enter your security code. (If you enter it incorrectly 3 times, the system hangs up and returns to standby.)
3. The system announces the time, the number of messages in memory, and a help prompt. It beeps intermittently to let you know it's waiting for a command.
4. When you hear beeping, enter a 2-digit command from the chart:

#1	Repeat message	#5	Stop playback
#2	Play message	#6	Turn the system on
#3	Skip message	#9	Turn the system off
#4	Delete message	#0	Hear help prompts

🔔 **If you don't press any keys for 15 seconds, the phone will hang up and return to standby.**

IMPORTANT INFORMATION

Solving Problems

If you have any trouble with your phone, check this section first. If you need help, visit the customer support page of our website listed on the front cover.

General Problems	Possible Solutions
No handsets can make or receive calls.	<ul style="list-style-type: none"> • Check the telephone cord connection. • Disconnect the base AC adaptor for a few minutes; then reconnect it.
A handset can't make or receive calls.	<ul style="list-style-type: none"> • Move the handset closer to the base.
A handset can make calls, but it won't ring.	<ul style="list-style-type: none"> • Make sure the ringer is turned on. • Make sure DND Mode is turned off (see page 18).
A handset is not working.	<ul style="list-style-type: none"> • Charge the battery for 15-20 hours. • Check the battery connection.
The phone keeps ringing when I answer on an extension.	<ul style="list-style-type: none"> • You may have to change the line mode. Contact Customer Service for instructions.
Audio Issues	Possible Solutions
Callers sound weak or soft.	<ul style="list-style-type: none"> • Move the handset closer to the base. • Keep the handset's battery fully charged. • Increase the earpiece volume.
There's a lot of noise or static on the line	<ul style="list-style-type: none"> • Check for interference from appliances (microwave ovens, TVs, etc.) or wireless devices (baby monitors, WiFi equipment, etc.). Move the handset or base away from the interference source. • Try to adjust the audio tone. During a call, press TONE to cycle through the three audio tone options: Low Tone, Natural Tone (recommended for hearing aid users), or High Tone. (The tone setting appears in the display as you do this.) • If you use a telecoil hearing aid, turn on T-coil mode (see page 12). • If you have any service that uses the phone line, add a DSL or telephone line filter (see page 31).

Caller ID Problems	Possible Solutions
Caller ID information does not display.	<ul style="list-style-type: none"> • Let calls ring twice before answering. • Make sure your Caller ID service is active.
Caller ID displays briefly and then clears.	<ul style="list-style-type: none"> • You may have to change the line mode. Contact Customer Service for instructions.
Caller ID displays, but I can't hear the CID announcements.	<ul style="list-style-type: none"> • Making sure Caller Announce (Text-To-Speech) is turned on (see page 19). • Increasing the ringer volume so the CID announcements are louder.
Multi-handset Problems	Possible Solutions
I can't transfer calls.	<ul style="list-style-type: none"> • Reset all the handsets (see page 31).
Two handsets can't talk to a caller.	<ul style="list-style-type: none"> • See if any handset is in Privacy Mode.
A handset says <i>Unavailable</i> .	<ul style="list-style-type: none"> • Move the handset closer to the base. • See if any handset is in Privacy Mode. • Reset the handset (see page 31).
I can't register a new handset.	<ul style="list-style-type: none"> • Reset the handset (see page 31). • See if you have 6 registered handsets.
Answering System Problems	Possible Solutions
The answering system does not work.	<ul style="list-style-type: none"> • Make sure the answering system is on. • Make sure the base is plugged in.
The system won't record messages.	<ul style="list-style-type: none"> • See if Record Time is set to Announce Only. • Delete messages (memory may be full).
A handset can't access the answering system.	<ul style="list-style-type: none"> • See if another handset is using the system. • Make sure the phone is in standby.
My outgoing message is gone.	<ul style="list-style-type: none"> • If there was a power failure, re-record your personal outgoing message.
I can't hear the base speaker.	<ul style="list-style-type: none"> • Make sure call screening is turned on. • Change the base speaker volume.
Messages are incomplete.	<ul style="list-style-type: none"> • Increase the Record Time. • Delete messages (memory full)
The system keeps recording when I answer on an extension.	<ul style="list-style-type: none"> • You may have to change the line mode. Contact Customer Service for instructions.

Installing a Line Filter or DSL Filter

A telephone line filter or DSL filter prevents services that use the phone line from causing interference on your phone. To get a line filter, contact your service provider or look in an electronics store.

Plug the filter into the telephone wall jack and plug the base into the filter. Make a test call to make sure the noise is gone.

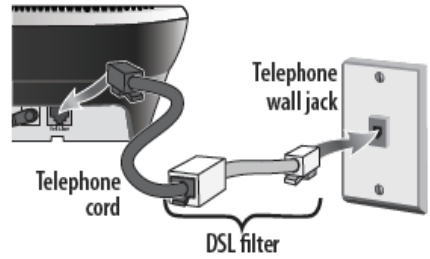

Liquid Damage

CAUTION: If the base is covered in liquid, disconnect the adapter and phone cord from the wall before touching it.

If the liquid is only on the exterior housing of the base or handset, wipe it off and use as normal. If you can hear liquid inside the housing:

1. Disconnect all cables and cords and remove all compartment covers.
2. If liquid is leaking from any vent or hole, turn the phone so that vent faces down. If not, place the largest vent face down.
3. Let dry for at least 3 days. Check for liquid inside the phone before replacing compartment covers and reconnecting cords.

Resetting a Handset

If you have trouble with a handset or if you want to replace one, reset it:

1. Press and hold **END/CLEAR** and **#/DND** at the same time until *System Reset* displays (about 5 seconds).
2. If you still have the base the handset is registered to, select *Deregister HS*, then select the handset you want to reset. If you don't have that base anymore, select *Base Unavailable*.
3. To confirm, select *Yes*. The handset displays *Handset not registered*.

Registering a Handset

If you see a "not registered" message on a handset, you must register it to a base before using it.

1. Place the handset in the base; the display should say *Handset Registering*.
2. Wait until the handset display says *Registration Completed* (about 30 seconds), then pick up the handset.

☒ **If you don't hear a dial tone or the display says *Registration Failed*, charge the battery completely, then try again.**

Adapter and Battery Information

AC Adaptor	Base	Charger
Part number	AAD-041S(M)	AAD-600S(M)
Input voltage	100-240V AC, 50/60Hz	100-240V AC, 50/60Hz
Output voltage	9V DC @ 350mA	9V DC @ 210mA

- Use only the supplied AC adaptors.
- Use the proper adapter for the base and any chargers.
- Do not place the unit in direct sunlight or subject it to high temperatures.

Battery Pack with Normal Use

Part number	BT-694, BT-694s or BT-694n
Capacity	650mAh (BT-694) or 500mAh (BT-694s) or 400mAh(BT-694n)
Talk time	about 10 hours
Standby time	about 7 days
Battery life	about 1 year

- Replace the battery when the talk or standby time becomes noticeably reduced. For replacements, visit the online shop on our website (see the front cover).
- When the battery gets low, the handset beeps and shows a low battery alert; put the handset in the cradle for recharging.

Rechargeable Battery Warning

- This equipment contains a rechargeable Nickel-Metal-Hydrate (Ni-MH) battery.
- Do not short-circuit the battery.
- The batteries in this equipment may explode if disposed of in a fire.
- Do not charge the batteries in any charger other than the one specified in the owner's manual. Using another charger may damage the battery or cause it to explode.

Rechargeable batteries must be recycled or disposed of properly.

Uniden works to reduce lead content in our products and accessories.

INDEX

A

Answer Machine 24
Any key answer 12
Auto Talk 12

B

Banner 12
Battery 32

C

Call Block 20
Caller ID 16
Call Transfer 21
Call Waiting 16
Chain Dialing 17
Clock 13
Conference Calling 21

D

Date & Time 13
Distinctive Ringer 18
DND 18

E

Earpiece Volume 18

F

Find HS 6

H

Headset 22

I

Intercom 22

K

Key Touch Tone 12

L

LCD Contrast 12
Line Filter 31

Liquid Damage 31

M

Multi-handset Features 21
Mute 8

N

Noise 29

P

Paging HS 11
Personal Ring 12
Phonebook 17
Privacy Mode 21

R

Redial 16
Registering the HS 31
Resetting the HS 31
Ringer Tone 12
Ringer Volume 8

S

Static 29

V

Voice Mail 10

W

Warranty 34

ONE-YEAR LIMITED WARRANTY

XDECT SSE35

IMPORTANT Satisfactory evidence of the original purchase is required for warranty service

Please refer to our Uniden website for any details or warranty durations offered in addition to those contained below.

Warrantor

The warrantor is either Uniden Australia Pty Limited ABN 58 001 865 498 ("Uniden Aust") or Uniden New Zealand Limited ("Uniden NZ") as the case may be.

Terms of Warranty

Uniden Aust/NZ warrants to the original retail purchaser only that the XDECT SSE35("the Product"), will be free from defects in materials and craftsmanship for the duration of the warranty period, subject to the limitations and exclusions set out below.

Warranty Period

This warranty to the original retail purchaser is only valid in the original country of purchase for a Product first purchased either in Australia or New Zealand and will expire one (1) year from the date of the original retail sale.

If a warranty claim is made, this warranty will not apply if the Product is found by Uniden to be:

- (A) Damaged or not maintained in a reasonable manner or as recommended in the relevant Uniden Owner's Manual;
- (B) Modified, altered or used as part of any conversion kits, subassemblies or any configurations not sold by Uniden Aust or Uniden NZ;
- (C) Improperly installed contrary to instructions contained in the relevant Owner's Manual
- (D) Repaired by someone other than an authorized Uniden Repair Agent in relation to a defect or malfunction covered by this warranty; or
- (E) Used in conjunction with any equipment, parts or a system not manufactured by Uniden.

Parts Covered

This warranty covers the Product and included accessories.

User-generated Data

This warranty does not cover any claimed loss of or damage to user-generated data (including but without limitation phone numbers, addresses and images) that may be stored on your Product.

Statement of Remedy

If the Product is found not to conform to this warranty as stated above, the Warrantor, at its discretion, will either repair the defect or replace the Product without any charge for parts or service. This warranty does not include any reimbursement or payment of any consequential damages claimed to arise from a Product's failure to comply with the warranty.

Our goods come with guarantees that cannot be excluded under the Australian Consumer Law. You are entitled to a replacement or refund for a major failure and for compensation for any other reasonably foreseeable loss or damage. You are also entitled to have the goods repaired or replaced if the goods fail to be of acceptable quality and the failure does not amount to a major failure.

This warranty is in addition to and sits alongside your rights under either the COMPETITION AND CONSUMER ACT 2010 (Australia) or the CONSUMER GUARANTEES ACT (New Zealand) as the case may be, none of which can be excluded.

Procedure for Obtaining Warranty Service

Depending on the country in which the Product was first purchased, if you believe that your Product does not conform with this warranty, you should deliver the Product, together with satisfactory evidence of your original purchase (such as a legible copy of the sales docket) to Uniden at the addresses shown below. You should contact Uniden regarding any compensation that may be payable for your expenses incurred in making a warranty claim. Prior to delivery, we recommend that you make a backup copy of any phone numbers, images or other data stored on your Product, in case it is lost or damaged during warranty service.

UNIDEN AUSTRALIA PTY LTD

Service Division
345 Princes Highway,
Rockdale, NSW 2216
Phone number: 1300 366 895
Email address: custservice@uniden.com.au

UNIDEN NEW ZEALAND LTD

Service Division
150 Harris Road, East Tamaki
Auckland 2013
Phone number: (09) 273 8377
Email address: service@uniden.co.nz

Uniden®

©2012 Uniden Australia Pty Ltd/Uniden New Zealand Limited
Printed in Vietnam U01UN465ZZZ(0)

Uniden[®]

SSE P1

Emergency Alert Pendant

For more exciting new products please visit our website:

Australia: www.uniden.com.au

New Zealand: www.uniden.co.nz

OWNER'S MANUAL

IMPORTANT SAFETY INSTRUCTIONS

The SSE P1 Pendant is an accessory product that must be registered to a compatible telephone model before use. Please read this Owner's Manual in full for details on the installation and operation of the SSE P1.

Basic safety precautions should always be followed to reduce the risk of fire, electric shock and injury to persons.

Some other things to help you make the most of your SSE P1 Pendant.

- **This unit is splashproof NOT waterproof.** Do not immerse the unit in water.
- The charger is not designed to be splash resistant. Do not place the pendant on the charger if the pendant is wet.
- If the pendant gets wet, wipe it with a soft dry cloth.
- Avoid using a telephone (other than a cordless type) during an electrical storm. There may be a remote risk of electric shock from lightning.
- Use the AC adaptor indicated in this manual.
- Do not expose the pendant to excessive heat, smoke, dust, chemicals and vibrations.

SAVE THESE INSTRUCTIONS!

Important Notice:

- Under power failure conditions this appliance may not operate. Please ensure that a separate telephone, not dependent on local power, is available for emergency use.

SSE P1 Pendant will not function properly in the following circumstances:

- If it is not registered properly with the compatible phone.
- If the battery is low.
- If the emergency (SOS) numbers have not been stored in the phone, then it will make only intercom calls.
- If the registered phone is not connected to power and telephone line.

General Notices for New Zealand Model:

- The grant of a NZ Telepermit for any item of terminal equipment indicates only that Telecom has accepted that the item complies with minimum conditions for connection to its network. It indicates no endorsement of the product by Telecom, nor does it provide any sort of warranty. Above all, it provides no assurance that any item will work correctly in all respects with another item of Telepermitted equipment of a different make or model, nor does it imply that any product is compatible with all of Telecom's network services.
- This equipment may not provide for the effective hand-over of a call to another device connected to the same line.

WHAT'S IN THE BOX?



SSE P1 Pendant with Charging Cradle

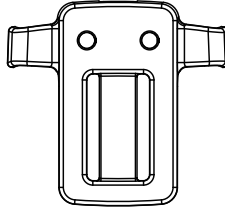

Belt Clip

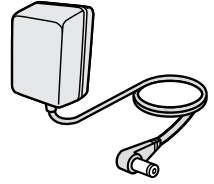

AC Adaptor

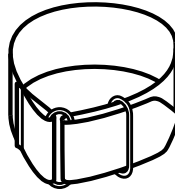

Wrist Band



Plastic Pin

Owner's Manual

- If any items are missing or damaged, contact your place of purchase immediately. **Never use damaged products!**
- Need help? Get answers at our website:
www.uniden.com.au for Australian model
www.uniden.co.nz for New Zealand model.

CONTENTS

GETTING TO KNOW YOUR PENDANT	5
GETTING STARTED	6
Charging Your Pendant	6
Attach the Belt Clip	7
Use the Wrist band	7
REGISTERING TO A BASE	8
Compatible Bases	8
Registration Methods	9
To SSE 37 Base	9
To SSE 35 Base	9
ADDING THE EMERGENCY NUMBERS	11
Editing the SOS Entries in the Phonebook	11
RECORDING THE OUTGOING MESSAGE	12
For SSE 37	12
For SSE 35	13
OPERATION	14
Make an Emergency Call	14
IMPORTANT INFORMATION	15
GENERAL INFORMATION	17
AC Adaptor	17
Battery Information	17
ONE-YEAR LIMITED WARRANTY	18

GETTING TO KNOW YOUR PENDANT

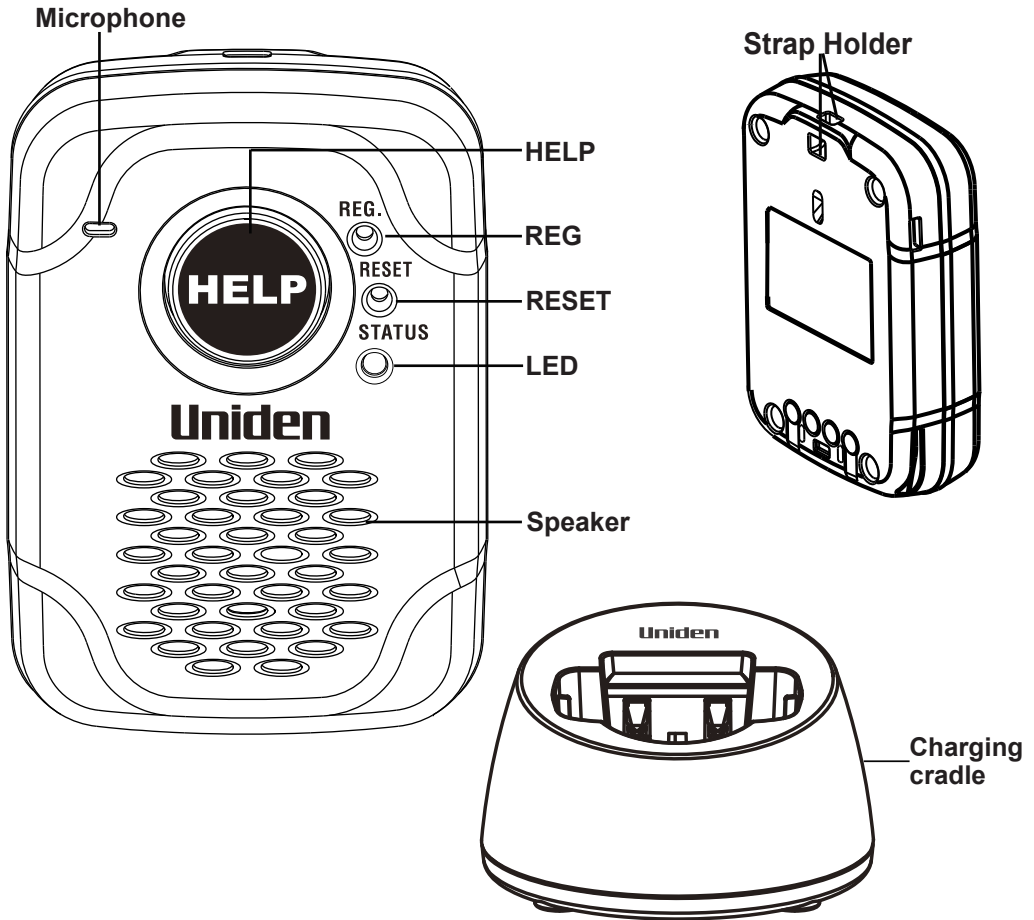

Buttons and Indicators	What it does
REG (Registration)	Use to register the Pendant with a compatible phone.
RESET	Use to reset the Pendant if registration fails. Pendant powers off after reset.
STATUS (LED)	Indicates the Pendant's status when the Pendant is in use. (See Status LED Indication table on page 6.)
SPEAKER	Listen to the other person through the speaker
MICROPHONE	Talk to the other person through the microphone.

GETTING STARTED

Before using the SSE P1 Pendant, it must first be charged, then registered to a compatible base. Finally, to get the most out of the SSE P1 Pendant's features, it is strongly recommended that emergency contact numbers are stored in the phonebook of the compatible base.

✗ Throughout the remainder of this manual the SSE P1 Pendant will be referred to as the Pendant.

Charging Your Pendant

The battery for the Pendant is pre-installed.

1. Connect the AC adaptor to the charger's DC IN 5.4V jack.
2. Plug the other end of the adaptor into a standard 240V AC power outlet.
3. Place the Pendant on the cradle with the **HELP** button facing forward while charging.

✗ Charge the Pendant completely (about 3 hours) before using.

✗ Do not charge the Pendant when the ambient temperature is below 0° C (32°F) or above 40° C (104°F).

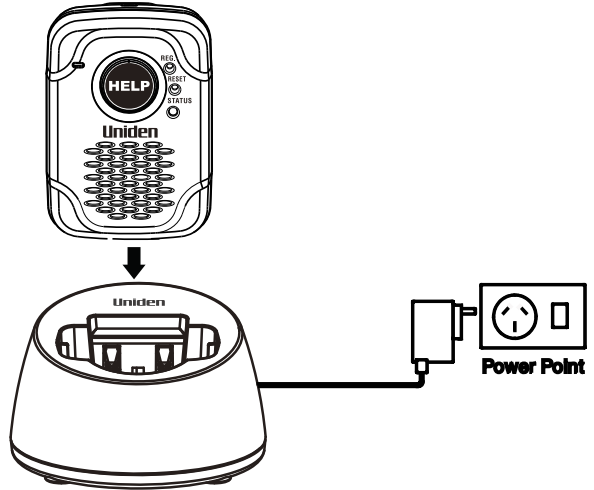

Status LED Indication	What it means
Blue	Charged
Red	Charging
Blinking Red	Battery is low
Blinking Blue	Successfully registered
Blinking Blue rapidly	During a call
Blink Blue and Red	During the registration process

✗ The LED lights only when the Pendant is being used. The Pendant automatically powers off after 2 minutes of inactivity.

Attach the Belt Clip

To attach a belt clip:

1. Line the belt clip with the grooves at the side of the Pendant.
2. Then gently push until it snaps into place.

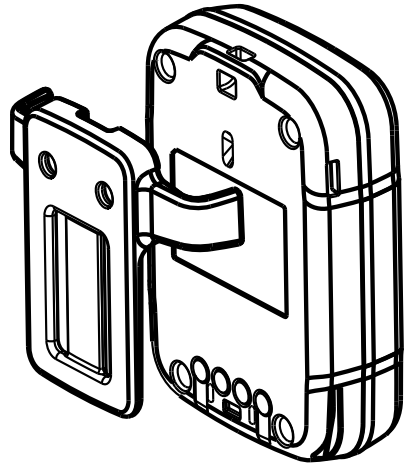

To remove the belt clip:

Gently pull out the belt clip from one groove and the other end will loosen on its own.

Use the Wrist band

To attach a wrist band:

✂ **The wrist band is attached to the Pendant with the help of the belt clip.**

1. Insert one end of the wrist band into one of the slots on the belt clip and then pull it out through the other end.
2. Next, attach the belt clip to the Pendant and then wrap the strap around your wrist and keep it place with the help of the velcro fastener.

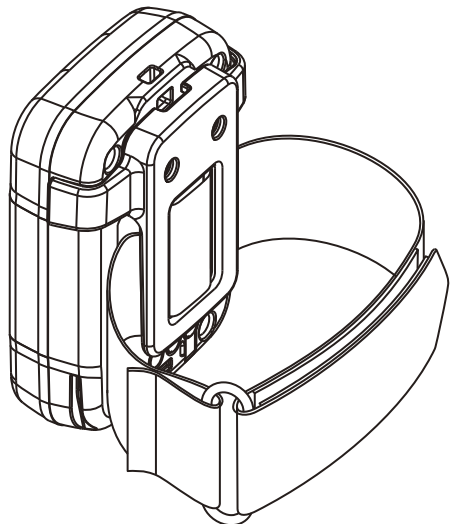
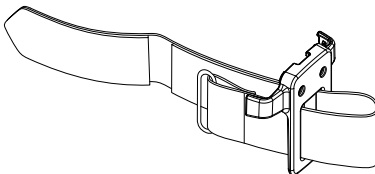
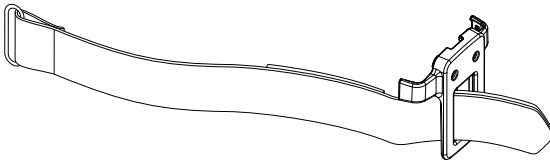

REGISTERING TO A BASE

⚠ The Pendant will not work until you register it to a compatible base.

Compatible Bases

The Pendant is designed for use with Uniden's;

- SSE 35 Base
- SSE 37 Base

SSE 37



SSE 35



Registration Methods

To SSE 37 Base

1. On the SSE 37 base, press **MENU** to open the menu and select the option, *Register Accy.* Press **OK**.



To SSE 35 Base

1. On the SSE 35 base, press and hold the **FIND HS** button.



2. On the Pendant

✗ **Make sure the Pendant is fully charged before registering to the base.**

a) With the Pendant on the charger, use the plastic pin provided to press and hold **REG** until the Status LED starts to blink blue and red.

OR

b) Take the Pendant off the charger and press **HELP** for 2-3 seconds until you hear a beep sound. Then use the plastic pin provided to press and hold **REG** until the Status LED starts to blink blue and red.

When the Pendant has been registered, a confirmation tone will sound.

Please Note:

✗ **If the registration fails, press the RESET switch with a pin and try again.**

✗ **Use the plastic pin (provided with the Pendant) or a blunt-tipped object like an uncurled paper clip to press the REG button. Do not press the REG button too hard using the PIN (or paperclip) as it may damage the button.**

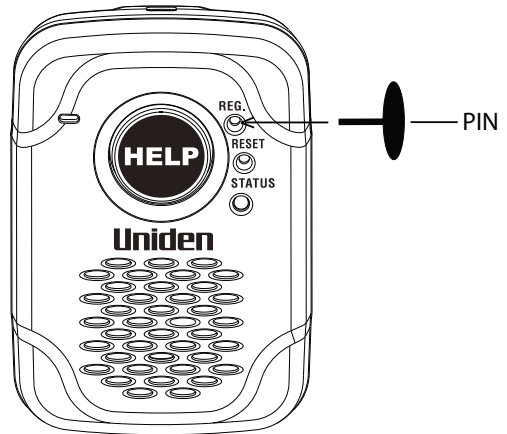

Test your Pendant

✗ **The Pendant is usually powered off. To turn it on, press and hold HELP for more than 2 seconds.**

1. Pick up the Pendant and press and hold **HELP** until you hear a confirmation tone.
2. The Pendant will make an intercom call to all handsets (SSE35) or handsets & base (SSE37).
3. Answer the intercom call on a handset or base.

✗ **Take this opportunity to test the range of the Pendant. Always use the Pendant within range of the base!**

To end the call, press **HELP** for 2 seconds or place the Pendant back in the cradle.

ADDING THE EMERGENCY NUMBERS

The Pendant can dial 5 emergency contact numbers that are stored in the phonebook of the compatible base.

The emergency contact entries in the phonebook must be saved as these names; SOS1, SOS2, SOS3, SOS4, SOS5.

For your convenience the SSE35 and SSE37 come with these name entries pre-loaded into the phonebook. These entries have no (emergency) numbers stored. You need to edit these entries to add your emergency contact numbers. Store the numbers with the area code and in the order in which you want.

✗ **It is important to inform the people whose contact numbers are entered in the SOS contact list. Do not forget to mention that if they receive an emergency call from the Pendant they have to press # on their phone in order to talk to the Pendant.**

Editing the SOS Entries in the Phonebook

After registering the Pendant to either the SSE 35 or the SSE 37 base, store the emergency (SOS) numbers in the phonebook, by following the steps given below.

On the SSE35 Handset or SSE37 Base/Handset:

1. Press **MENU**. Select *Phonebook* and press **OK**. *Phonebook Total:* displays.
2. Press **MENU**. Select *View* and press **OK**. The phonebook entries display.
3. Select *SOS1* entry and press **OK**. *SOS1* entry displays.
4. Press **MENU**. Select *Edit* and press **OK**. *Edit Name SOS1* displays.
5. Do not change the name. Press **OK**. *Edit Number* displays.
6. Enter the desired phone number and press **OK**.
7. The next settings are not required for emergency dial. Press **OK** to continue and save. *Saving and Done!* displays.

Repeat for *SOS2*, *SOS3*, *SOS4* and *SOS5* entries.

Creating New SOS Entries in the Phonebook

If no SOS entries are pre-stored in the phonebook then follow the steps above but select *Create New* at step 2 and name the entry *SOS1* and continue the steps to edit the number and save the entry.

✗ **If you enter less than 5 SOS numbers, for example, you add just one SOS number, the Pendant will call that one number 5 times. Or if you add 2 numbers, it will alternate between those two numbers till it completes 5 calls.**

RECORDING THE OUTGOING MESSAGE

You can record a personal emergency message, in addition to the preset recorded message, when the Pendant is registered to the SSE 35 and SSE 37 series. This will enable your family/friends to be able to identify your voice and attend the call and it will also assure them that it is not a prank call.

✂ **Your message can be up to 30 seconds long.**

If you do not record a personal message, then the default message, *“This is an emergency call, to accept press the hash key on your telephone now”* will play when the Pendant dials out the emergency number.

For SSE 37

To record a message on the SSE 37 base, when the Pendant is registered to the base, follow the steps given below.

1. Press and hold **ON/OFF+DELETE** keys on the base for 5 seconds.



2. The LCD displays, *“To Start, press OK”*. Press **OK**.
 - You will hear a prompt asking you to record your message.
3. Speak your message loud and clearly towards the front of the base, and then to stop recording, press **PLAY/STOP**. It's recommended that you add the instructions, *“to answer this call, press the hash key on your telephone”* to your personal message.
 - The Base will automatically playback the recorded message after recording. The base then returns to the standby mode.

Playback the Recorded Message

1. Press and hold **ON/OFF+REPEAT** keys on the base for 5 seconds. The LCD will display *“playback”* and the base starts to play the recorded emergency message.
2. Press **PLAY/STOP** to stop playing the recorded emergency message.
 - If the emergency message has not been recorded, nothing will play.

If you want to delete the message, press **DELETE** when the message is playing.

For SSE 35

To record a message on the SSE35 base, when the Pendant is registered to the base, follow the steps given below.

1. Press and hold **ON/OFF+DELETE** keys on the base for 5 seconds.



2. The base plays the following instruction, *“Record your Message”*.
 - After playing the confirmation tone, the Base starts recording the emergency message.
3. Speak your message loud and clearly towards the front of the base, and then to stop recording, press **PLAY/STOP**. It’s recommended that you add the instructions, *“to answer this call, press the hash key on your telephone”* to your personal message.
 - The Base will automatically playback the recorded message after recording. The base then returns to the standby mode.

Playback the Recorded Message

1. Press and hold **ON/OFF+REPEAT** keys on the base for 5 seconds. The base starts to play the recorded emergency message.
2. Press **PLAY/STOP** to stop playing the recorded emergency message.
 - If the emergency message has not been recorded, nothing will play.

If you want to delete the message, press **DELETE** when the message is playing.

OPERATION

Make an Emergency Call

1. Press and hold **HELP** for 2 seconds, until you hear a beep sound.

And after that?

2. The Pendant will first make an intercom call to all handsets registered to the main base.
 - a) If the intercom call is answered then the Pendant's microphone is activated and you can talk through the Pendant to the other handset.
 - b) If the other handsets are on an outside call or intercom call, then the Pendant will interrupt and join in with the outside or intercom call.
3. If there is no answer after 60 seconds, then it will dial out the first emergency number (stored in the SOS1 entry).



- a) As soon as the first emergency number is dialled, the pre-set emergency message will play, *"This is an emergency call, to accept press the hash key on your telephone now."*

This message will be heard on the Pendant's speaker and the outside line, and is repeated every 3 seconds. If a personal emergency message has been recorded, it will play that message first and then the pre-set message.
 - b) If the first emergency number is not answered after 60 seconds, then the next emergency number is dialled. This is repeated, if necessary, until 5 numbers have been dialled.
4. When the outside line answers the call and presses the # key, then the Pendant's microphone is activated and you can talk through the Pendant.

To end a call:

- Press and hold **HELP** for 2 seconds, or until you hear a beep tone, to disconnect an emergency call.
- or
- Place the Pendant in the cradle to end the call.
- ✕ **Ideally, place the Pendant back in the cradle so that the battery charges and the Pendant is ready for the next emergency call.**

IMPORTANT INFORMATION

- Test the Pendant's HELP function regularly to ensure that it is working properly.
- Always place the Pendant back in the cradle to ensure that the battery is charged and the Pendant is ready for the next emergency call.

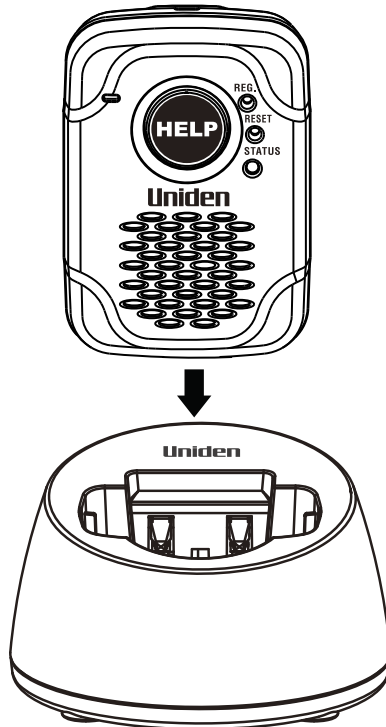

- The Pendant is meant to be used by your personal emergency contacts - family, friends, neighbours. Do not use the Pendant to dial the police or other emergency numbers. The emergency response systems might not be technically equipped to respond to the Pendant .
- The Pendant will always call the intercom first before dialling out the programmed emergency numbers.
- With the Pendant, you can reach out to 5 people. Ideally, try to add a contact number for the 5 available SOS numbers.

- **You have to ensure that the emergency numbers have been programmed, otherwise the Pendant will not dial out anything.**
- **Store the phone numbers with the area code and in the order in which you want.**
- **The emergency feature will stop automatically when all the 5 SOS numbers have been dialled, or until the call has been answered and the receiver has pressed the # key.**
- **It is important to inform the people whose names are entered in the SOS contact list. Do not forget to mention that they have to press the # key when they answer the emergency call, in order to activate the microphone on the Pendant .**
- **To cancel the emergency call either press and hold HELP for 2 seconds or until you hear a beep sound, or place the Pendant back in the cradle.**

GENERAL INFORMATION

AC Adaptor

Parts Number	Input Voltage	Output Voltage
PS-S0540NL2	100-240V~, 50-60Hz 150mA	5.4V 400mA

- Use only the supplied AC adaptor.
- Do not place the unit in direct sunlight or subject it to high temperatures.

Battery Information

Type	Capacity	Talk time	Standby Time
Lithium-ion	230mAh, 3.7VDC	about 5 hours	about 30 days

- Please contact your place of purchase if the battery fails.

ONE-YEAR LIMITED WARRANTY

SSE P1 Pendant

IMPORTANT Satisfactory evidence of the original purchase is required for warranty service

Please refer to our Uniden website for any details or warranty durations offered in addition to those contained below.

Warrantor

The warrantor is either Uniden Australia Pty Limited ABN 58 001 865 498 (“Uniden Aust”) or Uniden New Zealand Limited (“Uniden NZ”) as the case may be.

Terms of Warranty

Uniden Aust/NZ warrants to the original retail purchaser only that the XDECT SSE P1 (“the Product”), will be free from defects in materials and craftsmanship for the duration of the warranty period, subject to the limitations and exclusions set out below.

Warranty Period

This warranty to the original retail purchaser is only valid in the original country of purchase for a Product first purchased either in Australia or New Zealand and will expire one (1) year from the date of the original retail sale.

If a warranty claim is made, this warranty will not apply if the Product is found by Uniden to be:

- (A) Damaged or not maintained in a reasonable manner or as recommended in the relevant Uniden Owner’s Manual;
- (B) Modified, altered or used as part of any conversion kits, subassemblies or any configurations not sold by Uniden Aust or Uniden NZ;
- (C) Improperly installed contrary to instructions contained in the relevant Owner’s Manual
- (D) Repaired by someone other than an authorized Uniden Repair Agent in relation to a defect or malfunction covered by this warranty; or
- (E) Used in conjunction with any equipment, parts or a system not manufactured by Uniden.

Parts Covered

This warranty covers the Product and included accessories.

User-generated Data

This warranty does not cover any claimed loss of or damage to user-generated data (including but without limitation phone numbers, addresses and images) that may be stored on your Product.

Statement of Remedy

If the Product is found not to conform to this warranty as stated above, the Warrantor, at its discretion, will either repair the defect or replace the Product without any charge for parts or service. This warranty does not include any reimbursement or payment of any consequential damages claimed to arise from a Product's failure to comply with the warranty.

Our goods come with guarantees that cannot be excluded under the Australian Consumer Law. You are entitled to a replacement or refund for a major failure and for compensation for any other reasonably foreseeable loss or damage. You are also entitled to have the goods repaired or replaced if the goods fail to be of acceptable quality and the failure does not amount to a major failure.

This warranty is in addition to and sits alongside your rights under either the COMPETITION AND CONSUMER ACT 2010 (Australia) or the CONSUMER GUARANTEES ACT (New Zealand) as the case may be, none of which can be excluded.

Procedure for Obtaining Warranty Service

Depending on the country in which the Product was first purchased, if you believe that your Product does not conform with this warranty, you should deliver the Product, together with satisfactory evidence of your original purchase (such as a legible copy of the sales docket) to Uniden at the addresses shown below. You should contact Uniden regarding any compensation that may be payable for your expenses incurred in making a warranty claim. Prior to delivery, we recommend that you make a backup copy of any phone numbers, images or other data stored on your Product, in case it is lost or damaged during warranty service.

UNIDEN AUSTRALIA PTY LTD

Service Division
345 Princes Highway,
Rockdale, NSW 2216
Phone number: 1300 366 895
Email address: custservice@uniden.com.au

UNIDEN NEW ZEALAND LTD

Service Division
150 Harris Road, East Tamaki
Auckland 2013
Phone number: (09) 273 8377
Email address: service@uniden.co.nz

Uniden®

©2012 Uniden Australia Pty Ltd/Uniden New Zealand Limited
Printed in Vietnam U01UU283ZZZ(0)