

Uniden®

EZI30XLT Scanner

For more exciting new products please visit our website:

Australia: www.uniden.com.au

New Zealand: www.uniden.co.nz

OWNER'S MANUAL

IMPORTANT INFORMATION

PRECAUTIONS

Before you use this scanner, please read and observe the following:

EARPHONE WARNING!

Use only a genuine Uniden earphone. An incorrect earphone may be hazardous to your hearing. Turn down volume before connecting the earphone and then adjust volume to suit.

WARNING!

*Uniden **does not** represent this unit to be waterproof. To reduce the risk of fire or electrical shock, do not expose this unit to rain or moisture.*

CONTENTS

Important Information	2
Precautions	2
Contents	3
About Your New EZI30XLT Sscanner	4
Country Mode (Australia/New Zealand)	4
Features	5
Understanding Scanning	6
What is Scanning?	6
Conventional Scanning	6
Where To Obtain More Information	7
Included With Your Scanner	8
Setting Up Your Scanner	9
Installing and Replacing Batteries	9
Using Rechargeable Batteries	10
Connecting the Antenna	10
Connecting an Optional Antenna	11
Connecting the Earphone	11
Attaching the Belt Clip	12
EZI30XLT Controls and Display	13
A Look At The Keypad	14
A Look At The Display	16
Operation	17
To turn Power ON or OFF	17
To Adjust the Squelch Level	17
To Adjust the Volume Level	17
Operating modes	17
Instant Channels	18
Service Scan	18
Favourites Scan	19
Scanning Service & Favourites	19
Storing Frequencies	20
Editing Frequencies	21
Using Keylock	21
Using the Display Backlight	21
Troubleshooting	22
Resetting the Scanner	23
Care and Maintenance	24
General Use	24
Location	24
Cleaning	24
Repairs	24
Birdies	24
Specifications	25
Warranty	26

ABOUT YOUR EZI30XLT SCANNER

Thank you for purchasing a Uniden EZI30XLT Handheld Scanner. The scanner is versatile, compact, and easy to use.

The EZI30XLT comes pre-programmed with frequencies - organised into 8 Service banks for monitoring police, railroad, fire, ambulance, FM radio, air, marine and UHF CB frequencies.

Each Service bank has a Favourites bank for storing your favourite frequencies. Up to 210 frequencies can be stored in Favourites banks. Frequencies in Favourites can be copied from the Service bank. Manually store your favourite sports or events frequencies found through the internet and other sources. Visit the EZI30XLT page on the website for the latest information on sports and events frequencies.

Australia: www.uniden.com.au

New Zealand: www.uniden.co.nz

Additionally you have 3 Instant channels which are one-touch keys to store your 3 favourite frequencies.

COUNTRY MODE (AUSTRALIA/NEW ZEALAND)

The EZI30XLT is set to the Australian mode by default.

The Police, RailRoad, Fire and Ambulance banks have select pre-programmed frequencies - one set for Australia and another set for New Zealand. Switching the country mode alternates between the select pre-programmed frequencies of these service banks.

The country mode can be switched between Australia and New Zealand as follows:

- Turn on the power while pressing down **(Hold)**. The display will show the current setting; **AUS** for Australian mode or **nL** for New Zealand mode.
- Press **▲** to change the setting.
- Press **(Store)** to store the country mode. The scanner displays the volume level and starts in the last mode. The country mode is remembered for the next power on.

FEATURES

BAND COVERAGE

Range (MHz)	Step (kHz)	Mode	Service
75.0000 - 77.99375	6.25	FM	VHF Low Band
78.0000 - 85.0000	6.25	FM	VHF Low Band
88.0000 - 107.9000	100	FMB	FM Broadcast
108.0000 - 136.9875	12.5	AM	Aircraft Band
137.0000 - 147.99375	6.25	FM	2 Meter Amateur Band
148.0000 - 174.0000	6.25	FM	VHF High Band
410.0000 - 489.0000	12.5	FM	Land Mobile Radio

“FMB” means FM Broadcast demodulation [WFM (Broadcast)].

PRE-PROGRAMMED SERVICE SCAN

8 banks of pre-programmed frequencies ready for scanning.

POLICE	FM Radio Broadcast
RAILROAD	AIRCRAFT Band
FIRE	MARINE
AMBULANCE	UHF CB

FAVOURITE SCAN

Up to 210 user programmable frequencies can be stored and scanned in Favourites scan mode. Each SERVICE has a FAVOURITES bank for storing and scanning up to 20 of your favourite frequencies. An additional miscellaneous (MISC) bank is available only in the Favourites mode for storing and scanning an additional 50 favourites frequencies.

INSTANT CHANNEL

3 one-touch keys to store your 3 favourite frequencies.

DROPOUT DELAY

The scanner, during scan, pauses at the end of a transmission to wait for a reply. Delay time is 2 seconds.

LCD BACKLIGHT

You can turn the orange LCD back light on/off.

KEY LOCK

Lets you lock the scanner's keys to help prevent accidental changes to the scanner's programming.

MEMORY BACK UP

Keeps the frequencies stored in memory for an extended time if the scanner loses power.

BATTERY LOW ALERT

Warns you when the battery power gets low.

UNDERSTANDING SCANNING

This section provides you with background on how scanning works. You don't really need to know all of this to use your scanner, but some background knowledge will help you get the most from your EZI30XLT.

What is Scanning?

Unlike standard AM or FM radio stations, most two-way communications do not transmit continuously. Your EZI30XLT scans programmed channels until it finds an active frequency, then stops on that frequency and remains on that channel as long as the transmission continues. When the transmission ends, the scanning cycle resumes until the scanner receives another transmission.

Conventional Scanning

Conventional scanning is a relatively simple concept. Each group of users in a conventional system is assigned a single frequency (for simplex systems) or two frequencies (for repeater systems). Any time one of them transmits, their transmission always goes out on the same frequency. Up until the late 1980's this was the primary way that radio systems operated.

Even today, there are many 2-way radio users who operate using a conventional system:

- Aircraft
- Emergency Services (Police/Fire/Ambulance)
- Railroad
- Broadcast FM stations
- UHF CB Radio
- Marine Radio
- Many business radio users

When you want to store a conventional system, all you need to know is the frequencies they operate on. When you are scanning a conventional system, the scanner stops very briefly on each channel to see if there is activity. If there isn't, the scanner quickly moves to the next channel. If there is, then the scanner pauses on the transmission until it is over.

UNDERSTANDING SCANNING

Where To Obtain More Information

By itself, this manual really only provides part of what you need to know to have fun scanning – how to program and use the scanner.

Information On The Internet

The Internet is a great source for current frequencies and information about scanning. Many web sites have lists of frequencies for your area.

The EZI30XLT can tune to frequencies used at major sports and events. Visit the EZI30XLT page on the website for the latest information on sports and events frequencies.

Australia: www.uniden.com.au

New Zealand: www.uniden.co.nz

INCLUDED WITH YOUR SCANNER

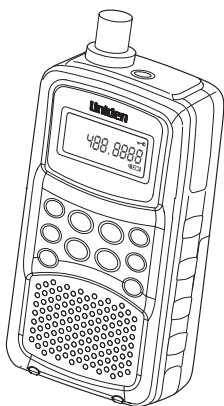

EZI30XLT

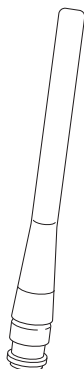

Antenna

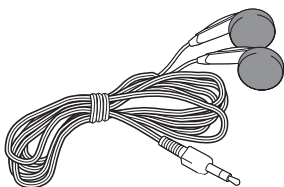

Earphone

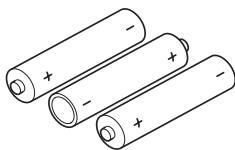

3x AA Alkaline Batteries

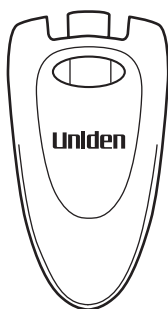

Belt Clip

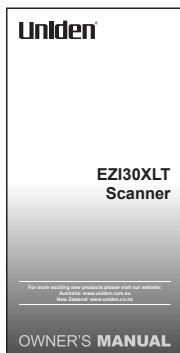

Owner's Manual

NOTE: If any of these items are missing or damaged, contact your place of purchase.

SETTING UP YOUR SCANNER

These guidelines will help you install and use your new scanner:

- If your scanner receives interference or electrical noise, move the scanner or its antenna away from the source.
- To improve the scanner's reception, use an optional external antenna designed for multiband coverage. (You can purchase this type of antenna at a local electronics store). If the optional antenna has no cable, use 50 ohm coaxial cable for lead-in. A mating plug might be necessary for the optional antennas.
- Do not use the scanner in high-moisture environments such as the kitchen or bathroom.
- Avoid placing the scanner in direct sunlight or near heating elements or vents.

Installing and Replacing Batteries

You can power your scanner using three AA alkaline batteries.

1. Make sure the power is turned off.
2. If the belt clip is attached, remove it (See page 12).
3. Slide the battery compartment cover.

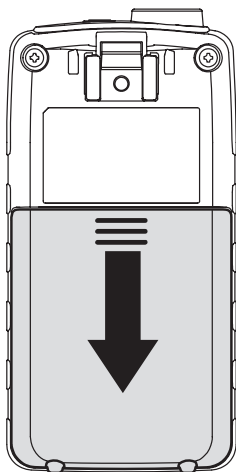

SETTING UP YOUR SCANNER

4. Install three batteries in the compartment as indicated by the polarity symbols (+ and -) marked inside.

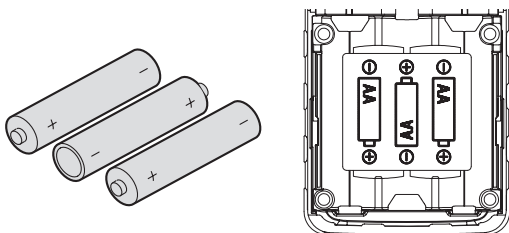

5. Replace the cover.

Using Rechargeable Batteries

You can also use three rechargeable batteries (Ni-MH) to power your scanner. Before you use rechargeable batteries, make sure the batteries are fully charged.

CAUTIONS:

- Use only fresh batteries of the required size and recommended type.
- Always remove old or weak batteries. Batteries can leak chemicals that destroy electronic circuits.
- Do not mix old and new batteries, different types of batteries (standard, alkaline, or rechargeable), or rechargeable batteries of different capacities.

Connecting the Antenna

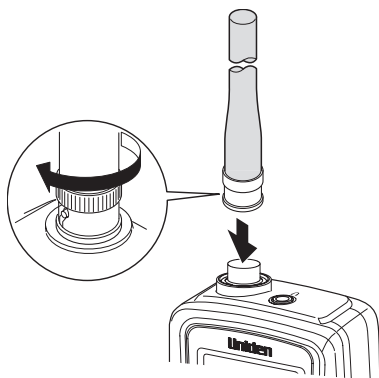

SETTING UP YOUR SCANNER

To attach the supplied flexible antenna to the connector on the top of your scanner, align the slots around the antenna's connector with the tabs on the scanner's BNC connector. Then slide the antenna's connector down over the scanner's connector and rotate the antenna connector's outer ring clockwise until it locks into place.

Connecting an Optional Antenna

The scanner's BNC connector makes it easy to connect a variety of optional antennas, including an external mobile antenna or outdoor base station antenna.

NOTE: Always use 50-ohm, RG-58, or RG-8, coaxial cable to connect an outdoor antenna. If the antenna is over 15 metres from the scanner, use RG-8 lowloss dielectric coaxial cable. You can get a BNC adapter at your local electronics store.

Connecting the Earphone

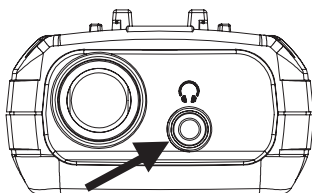

For private listening, you can plug the 3.5mm miniplug earphone into the headphone jack on top of your scanner. This automatically disconnects the internal speaker.

WARNING!

If you connect an external speaker to the scanner's headphone jack, never connect the audio output line to a power supply and ground. This might damage the scanner.

SETTING UP YOUR SCANNER

Attaching the Belt Clip

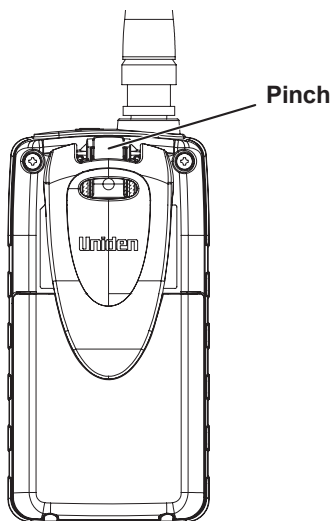

To make your scanner easier to carry when you are on the go, use the supplied belt clip. Slide the belt clip into the hanger piece on the back of the scanner. To remove, slide up the belt clip pulling the pinch at the middle of the belt clip.

EZI30XLT CONTROLS AND DISPLAY







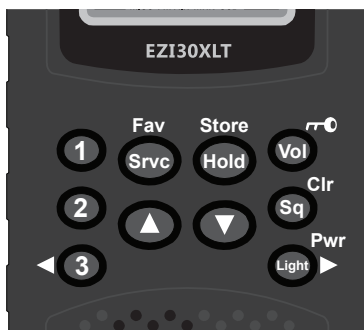

EZI30XLT CONTROLS AND DISPLAY



A Look At The Keypad



Your scanner's keys have various functions labelled on the key tops and below the keys.

Key Name	Description
	<ul style="list-style-type: none">• Press to go to volume control mode.• Press & hold this key to disable the keypad.
	<ul style="list-style-type: none">• Press to go to squelch control mode.• Press & hold to clear channel memory in Favourite Scan Hold Mode or Instant Channel Mode.
	<ul style="list-style-type: none">• Press to turn on/off the LCD back light.• Press & hold to turn the power on/off.• Press to move the digit to right in Edit Favourite / Instant Channel Mode.
	<ul style="list-style-type: none">• Press to select Instant channel 1.• Press & hold to store Instant channel 1.
	<ul style="list-style-type: none">• Press to select Instant channel 2.• Press & hold to store Instant channel 2.
	<ul style="list-style-type: none">• Press to select Instant channel 3.• Press & hold to store Instant channel 3.• Press to move the digit to left in Edit Favourite / Instant Channel Mode.

EZI30XLT CONTROLS AND DISPLAY

Key Name	Description
	<ul style="list-style-type: none">• Press to toggle change the service bank.• Press & hold to toggle between Service Scan Mode and Favourite Scan Mode. (Or between Service Scan Hold Mode and Favourite Scan Hold Mode.)
	<ul style="list-style-type: none">• Press to Start/Stop Scan Mode.• Press & hold to go to Programming Channel Mode in Service Scan Hold Mode or while monitoring a frequency.• Press & hold to store the frequency in Programming Channel Mode.
	<ul style="list-style-type: none">• Press to change volume level in volume control mode.• Press to change squelch level in squelch control mode.• Press to change the direction of the scan.• Press to resume scanning while monitoring a frequency.• Press to select channels in Service / Favourite Scan Hold Mode or Programming Channel Mode.• Press for more than one second to rapidly select channels upwards or downwards in Service / Favourite Scan Hold Mode or Programming Channel Mode.• Press to edit frequencies in Edit Favourite / Instant Channel Mode.• Press for more than one second to rapidly edit frequencies upwards or downwards in Edit Favourite / Instant Channel Mode.

EZI30XLT CONTROLS AND DISPLAY

A Look At The Display



The display has indicators that show the scanner's current operating status. The display information helps you understand how your scanner operates.

- FAV** - appears when Favourites or Instant mode is selected.
- POL** - appears when Police bank is selected.
- RAIL** - appears when Railroad bank is selected.
- FIRE** - appears during when Fire bank is selected.
- AMBL** - appears during when Ambulance bank is selected.
- 1** - appears when Instant channel 1 is selected.
- 2** - appears when Instant channel 2 is selected.
- 3** - appears when Instant channel 3 is selected.
- KEY** - appears when keylock is activated.
- HOLD** - appears when Hold is selected during scanning modes.
- appears during Instant mode
- MISC** - appears when Miscellaneous bank is selected during Favourites mode.
- FM** - appears when FM Radio band is selected.
- AIR** - appears when Air band is selected.
- MRN** - appears when Marine band is selected.
- UCB** - appears when UHF CB band is selected.
- BATT** - appears when battery level is low.

OPERATION

To turn Power ON or OFF

1. Press & hold (**Pwr**).

When power is turned on the volume level is displayed momentarily.



To Adjust the Squelch

What is the Squelch?

When there is no signal present on a particular frequency the radio only hears noise. The Squelch feature mutes the audio when there is no signal or no strong signal present. By adjusting the squelch level you control how strong a signal needs to be to open the squelch and unmute the audio.

1. Press (**Sq**) and then adjust using the ▲ / ▼ keys. The squelch level can range from 0 (open squelch) to 10 (tight squelch).

TIP! Set the squelch level to 5 to start, you can always adjust it later.

To Adjust the Volume

1. Press (**Vol**).

Then adjust using the ▲ / ▼ keys.
The volume level can range from 0 (no volume) to 30 (maximum).



Operating modes

- INSTANT Channels (1), (2) and (3)
- SERVICE scan
- FAVOURITES scan

OPERATION

Instant Channels

The INSTANT channels are 3 one-touch keys to store your 3 favourite frequencies. The channels remain empty until you store a frequency to them.

At any time press **(1)**, **(2)** or **(3)** to select the instant channel.



1, **2** or **3** shows at the top of the display.

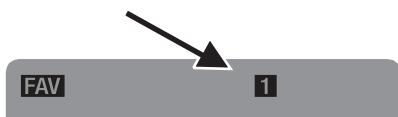

To store an Instant channel:

1. Select the desired Instant channel **(1)**, **(2)** or **(3)**;
2. Press & hold **(Store)** to enter the STORE mode. The editable digit flashes.
3. Use the ◀/▲/▼/▶ keys to select the desired frequency.
4. Press & hold **(Store)** to store the frequency to the instant channel.



*Ex: Store Instant **2**,
Select Desired Frequency*

To store a frequency that is displayed during SCAN mode to an Instant channel;

1. Press & hold **(1)**, **(2)** or **(3)** to immediately store that frequency to the Instant key.

To clear the Instant channel:

1. Press & hold **(Clr)** during Instant mode.

Service Scan

The Service mode scans the 8 pre-programmed SERVICE banks;

POL	POLICE	FM	FM Radio Broadcast
RAIL	RAILROAD	AIR	AIRCRAFT Band
FIRE	FIRE	MRN	MARINE
AMBL	AMBULANCE	UCB	UHF CB

OPERATION

Favourites Scan

Each SERVICE bank has a FAVOURITES bank which remains empty until you store your favourite frequencies to it.

An additional miscellaneous (MISC) bank is available in the Favourites mode.

Scanning Service & Favourites

To go to scan mode or scan the next bank:

1. Press **(Srcv/Fav)**. Scan starts automatically. When there are no frequencies stored in the Favourites bank then the display flashes "noCH".



Ex: Service scan, AIR bank



Ex: Favourites scan, no channels

NOTE: Only one bank can be scanned at a time.
The banks can be changed in the following order;
POL > RAIL > FIRE > AMBL > MISC* > FM > AIR > MRN > UCB
*Available only in Favourites mode.

To switch scan modes between Service scan and Favourite scan:

1. Press & hold **(Srcv/Fav)**.
In Service mode the **FAV** icon does not show on the display.
In Favourites mode the **FAV** icon shows on the display.



Ex: Service scan



Ex: Favourites scan

To pause scan:

1. Press **(Hold)** at any time to pause scan on the current frequency.
2. Use the **▲ / ▼** keys to go to the previous/next frequency in the service bank or the previous/next channel in the favourites bank.
3. Press **(Hold)** again to resume scan.



Ex: Service scan Hold

OPERATION

Storing Frequencies

To store a Service bank frequency to the Favourites bank:

1. Go to service scan mode. When a desired frequency is found press **(Hold)** to pause scan.
2. Press & hold **(Store)** to enter the STORE mode. The display toggles between frequency and the next available channel in the Favourites bank.
3. Use the **▲ / ▼** keys to select the desired favourites channel to store the frequency to.



Ex: Service scan Hold

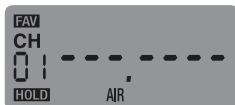

Ex: Store Favourites, CH 01 (AIR)

TIP! Press **(Srcv/Fav)** to select the MISC favourites bank.

4. Press & hold **(Store)** to store the frequency. The radio stays in the favourites mode.

To manually store a frequency to the Favourites bank:

1. Go to favourites mode and select desired bank.
2. Press **(Hold)** to pause scan.
3. Use **▲ / ▼** to select desired channel.

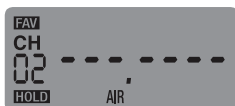

Ex: Store Favourites, CH 02 (AIR)

4. Press & hold **(Store)** to enter the STORE mode. The editable digit flashes.
5. Use the **◀ / ▲ / ▼ / ▶** keys to select the desired frequency.
6. Press & hold **(Store)** to store the frequency.



Ex: Store Favourites, Select Desired Frequency (AIR)

To store a frequency to an Instant Channel

See Instant Channels on page 18.

OPERATION

Editing Frequencies

1. Go to a desired Favourites or Instant channel.
2. Press & hold **(Store)** to enter the STORE mode. The editable digit flashes.
3. Use the ◀ / ▲ / ▼ / ▶ keys to edit the frequency.
4. Press & hold **(Store)** to store the frequency.



Ex: Edit Favourites, Select Desired Frequency CH 03 (FIRE)

To clear the Favourite or Instant channel:

1. Press & hold **(Clr)** while the channel is displayed.

Using Keylock

Use the scanner's keylock to protect it from accidental program changes. When the scanner's keys are locked, the only controls that operate are **(Vol / 🔒)**, **(Light / Pwr)** and ▲ / ▼ when volume level is displayed.

1. Press & hold **(Vol / 🔒)** to turn key lock on/off. A confirmation tone sounds. 🔒 appears while key lock is on.

NOTE: Using keylock does not prevent the scanner from scanning channels.

Using the Display Backlight

1. Press **(Light/Pwr)** to turn the backlight on/off. The backlight is off when power is turned on. The display lights for 30 seconds when backlight is turned on.

TROUBLESHOOTING

If your EZI30XLT is not performing properly, try the following steps.

Problem	Possible Cause	Suggestion
Improper reception.	The scanner's antenna might need to be adjusted.	Check the antenna connection or move or reposition the antenna.
		Move the scanner.
		You might be in a remote area that could require an optional multi-band antenna. Check with your dealer or local electronics store.
Scan won't stop.	The squelch might need to be adjusted.	Adjust the squelch threshold. See "To adjust the squelch" on page 17.
	The antenna might need to be adjusted.	Check the antenna connection.
	The channel's frequency might not be stored in favourites.	Make sure the channel's frequency is stored in the scanner's favourites bank.
	The channel might not be active.	Wait for a transmission on the channel.
Scan won't start.	You must be service or favourites mode.	Press (Srvc/Fav). If HOLD is showing press (Hold) to resume.
	The squelch might need to be adjusted.	Adjust the squelch threshold. See "To adjust the squelch" on page 17.
	The antenna might need to be adjusted.	Check the antenna connection.

TROUBLESHOOTING

Resetting the Scanner

If the scanner's display locks up or stops operating properly, you might need to reset the scanner.

CAUTION:

This procedure clears all the information you have stored in the scanner. Before you reset the scanner, try turning it off and on to see if it begins working properly. Reset the scanner only when you are sure it is not working properly.

1. Turn off the scanner.
2. While holding down **(Hold)** and **(2)**, turn on the scanner. It takes about 1 second to initialize and **CLEAR** appears.

CARE AND MAINTENANCE

Keep the scanner dry. If it gets wet, wipe it dry immediately. Use and store the scanner only in normal temperature environments. Handle the scanner carefully: do not drop it. Keep the scanner away from dust and dirt, and wipe it with a damp cloth occasionally to keep it looking new.

General Use

- Always write down the programmed frequencies in the event of memory loss.
- If memory is lost, simply reprogram each channel. The display shows - - - - - in all channels when there has been a memory loss.
- Always press each button firmly until you hear the entry tone for that key entry.

Location

- Do not use the scanner in high-moisture environments such as the kitchen or bathroom.
- Avoid placing the unit in direct sunlight or near heating elements or vents.
- If the scanner receives strong interference or electrical noise, move it or its antenna away from the source of the noise. If possible, a higher elevation might provide better reception.
- Also try changing the height or angle of the antenna.

Cleaning

- Clean the outside of the scanner with a mild detergent.
- To prevent scratches, do not use abrasive cleaners or solvents. Be careful not to rub the LCD window.
- Do not use excessive amounts of water.

Repairs

Do not attempt any repair. The scanner contains no user serviceable parts.

Birdies

All radios can receive “birdies” (undesired signals). If your scanner stops during Scan mode and no sound is heard, it might be receiving a birdie. Birdies are internally generated signals inherent in the electronics of the receiver.

Press ▲ / ▼ to resume scanning.

SPECIFICATIONS

Channels (Favourites + Instant):.....213

Frequency Range (in MHz) See page 5

Sensitivity (12 dB SINAD) (Nominal)

78.0000 MHz (FM).....	0.4 μ V
84.1250 MHz (FM).....	0.3 μ V
90.0000 MHz (FMB).....	0.8 μ V
107.5000 MHz (FMB).....	0.9 μ V
118.8000 MHz (AM).....	0.4 μ V
127.1750 MHz (AM).....	0.4 μ V
135.5000 MHz (FM).....	0.4 μ V
138.1500 MHz (FM).....	0.3 μ V
162.4000 MHz (FM).....	0.3 μ V
173.2250 MHz (FM).....	0.3 μ V
410.5000 MHz (FM).....	0.3 μ V
453.2500 MHz (FM).....	0.3 μ V
488.8750 MHz (FM).....	0.3 μ V

Operating Temperature

Normal.....-20°C to +60°C

Scan Rate:.....27 channels per second (Nominal)

IF Rejection (at 162.4 MHz).....70 dB (Nominal)

IF Frequencies (Nominal)

1st IF.....70.950 MHz

2nd IF.....450 kHz

Audio Output.....490 mW maximum

Built-in Speaker.....32 mm dia, 24 ohm
Dynamic Type

Current Drain

Squelched.....66 mA

Full Output (Light off).....190 mA

Power Requirements 3 AA Alkaline Batteries (4.5V DC),
or 3 AA Rechargeable Ni-MH Batteries (3.6V DC)

Antenna:.....50 ohms (Impedance)

External Jacks:.....Antenna Jack BNC Type
Ext. Earphone Jack 3.5 mm

Size (without antenna and belt clip):
.....53mm (W) x 28mm (D) x 104mm (H)

Weight (without Antenna and battery):.....100 g

Features, specifications, and availability of optional accessories are all subject to change without notice.

WARRANTY

UNIDEN EZI30XLT SCANNER

IMPORTANT: Satisfactory evidence of the original purchase is required for warranty service

Please refer to our Uniden website for any details or warranty durations offered in addition to those contained below.

Warrantor: The warrantor is either Uniden Australia Pty Limited ABN 58 001 865 498 ("Uniden Aust") or Uniden New Zealand Limited ("Uniden NZ") as the case may be.

Terms of Warranty: Uniden Aust/NZ warrants to the original retail purchaser only that the EZI30XLT Radio ("the Product"), will be free from defects in materials and craftsmanship for the duration of the warranty period, subject to the limitations and exclusions set out below.

Warranty period: This warranty to the original retail purchaser is only valid in the original country of purchase for a Product first purchased either in Australia or New Zealand and will expire one (1) year from the date of the original retail sale.

If a warranty claim is made, this warranty will not apply if the Product is found by Uniden to be:

- (A) Damaged or not maintained in a reasonable manner or as recommended in the relevant Uniden Owner's Manual;
- (B) Modified, altered or used as part of any conversion kits, subassemblies or any configurations not sold by Uniden Aust or Uniden NZ;
- (C) Improperly installed contrary to instructions contained in the relevant Owner's Manual
- (D) Repaired by someone other than an authorized Uniden Repair Agent in relation to a defect or malfunction covered by this warranty; or
- (E) Used in conjunction with any equipment, parts or a system not manufactured by Uniden.

Parts Covered: This warranty covers the Product and included accessories.

User-generated Data: This warranty does not cover any claimed loss of or damage to user-generated data (including but without limitation phone numbers, addresses and images) that may be stored on your Product.

Statement of Remedy: If the Product is found not to conform to this warranty as stated above, the Warrantor, at its discretion, will either repair the defect or replace the Product without any charge for parts or service. This warranty does not include any reimbursement or payment of any consequential damages claimed to arise from a Product's failure to comply with the warranty.

WARRANTY

Our goods come with guarantees that cannot be excluded under the Australian Consumer Law. You are entitled to a replacement or refund for a major failure and for compensation for any other reasonably foreseeable loss or damage. You are also entitled to have the goods repaired or replaced if the goods fail to be of acceptable quality and the failure does not amount to a major failure.

This warranty is in addition to and sits alongside your rights under either the COMPETITION AND CONSUMER ACT 2010 (Australia) or the CONSUMER GUARANTEES ACT (New Zealand) as the case may be, none of which can be excluded.

Procedure for obtaining warranty service: Depending on the country in which the Product was first purchased, if you believe that your Product does not conform with this warranty, you should deliver the Product, together with satisfactory evidence of your original purchase (such as a legible copy of the sales docket) to Uniden at the addresses shown below. You should contact Uniden regarding any compensation that may be payable for your expenses incurred in making a warranty claim. Prior to delivery, we recommend that you make a backup copy of any phone numbers, images or other data stored on your Product, in case it is lost or damaged during warranty service.

UNIDEN AUSTRALIA PTY LTD

Service Division

345 Princes Highway,
Rockdale, NSW 2216

Phone: 1300 366 895

Email: custservice@uniden.com.au

UNIDEN NEW ZEALAND LTD

Service Division

150 Harris Road, East Tamaki
Auckland 2013

Phone: (09) 273 8377

Email: service@uniden.co.nz

THANK YOU FOR BUYING A UNIDEN PRODUCT.

Uniden[®]

© 2011 Uniden Australia Pty Limited. Uniden New Zealand Ltd.
Printed in PRC. UBZZ01366ZB(1)