

Uniden®

BW3451R+1 **4.3" LCD Portable Wireless Baby Monitoring System**

*For more exciting new products please visit our website:
Australia: www.uniden.com.au*

OWNER'S MANUAL

IMPORTANT SAFETY INSTRUCTIONS

This manual contains important information about this product's operation. If you are installing this product for others, you must leave this manual or a copy with the end user.

When using your equipment, always follow basic safety precautions to reduce the risk of fire, electric shock and injury to persons, including the following:

- **This equipment is NOT waterproof.** DO NOT expose it to rain or moisture.
- DO NOT immerse any part of the product in water. Do not use this product near water, e.g., near a bathtub, wash bowl, kitchen sink or laundry tub, in a wet basement or near a swimming pool.
- To avoid any risk of electric shock from lightning, avoid handling any electronic devices (except battery powered ones) during an electrical storm.
- Use only the power cord and/or batteries indicated in this manual. Never dispose of any batteries in a fire: they may explode. Check with local codes for possible special disposal instructions.
- Never tug or pull on any power cord: be sure to leave some slack in the cord when placing your equipment, and always use the plug to unplug cord from the wall outlet.
- Never leave power cords where they can become crushed, cut, or frayed; when running power cords, avoid letting them rub against any sharp edges or lie across any high traffic areas where people might trip over them.
- Do not use the device if the adaptor cords or plugs have been damaged, the unit has been exposed to liquids, or the unit has been dropped or is damaged.

Warning to Parents and Other Users

Failure to follow these warnings and the assembly instructions could result in serious injury or death. This product is not designed or intended for use as a medical monitor, nor should this product be used as a substitution for medical or parental supervision. Always be sure that both the transmitter and receiver are working properly, and are within range of each other.

STRANGULATION HAZARD. Keep the adaptor cords out of the reach of children.

WARNING: KEEP OUT OF THE REACH OF CHILDREN.

Allow for proper ventilation when units are in use. Do not cover the camera or receiver with any object such as a blanket. Do not place it in a drawer or in any location which would muffle the sound or interfere with the normal flow of air.

SAVE THESE INSTRUCTIONS!

For best results

To avoid damage to your equipment, follow these simple precautions:

- Do not drop, puncture or disassemble any part of the equipment. There are no user-serviceable parts inside.
- Do not expose the equipment to high temperatures, and avoid leaving the equipment in direct sunlight for more than a few minutes. Heat can damage the case or electrical parts.
- Do not place heavy items on top of the equipment or expose the equipment to heavy pressure.
- Remove the power adaptor during long periods between usages.
- Clean only with a dry cloth.

Failure to follow the instructions in this operating manual will void the warranty. Uniden assumes no liability for damages to property or injury to persons caused by improper handling or failure to comply with these safety instructions.

CONTENTS

WHAT'S IN THE BOX?	6
INSTALLATION	7
MONITOR INSTALLATION	7
CAMERA INSTALLATION	7
BW31PTZ Wall Mount Bracket	8
BW3000 Wall Mount	9
BASIC OPERATION	10
BW31PTZ	10
BW3000.....	11
WIRELESS MONITOR	13
LCD Display	16
USING THE BW3451R+1	18
Viewing Modes	18
SYSTEM MENUS	19
SYSTEM	19
Date/Time	20
Brightness	20
Format Storage	21
Factory Reset	21
Language	22
Temperature Display Unit	22
Temperature Alert Range	23
ALERT	24
RECORD	25
Quality	25
Record Time	26
VOX	26
Overwrite	27
CAMERA	28
Pair	28
On/Off	29
POWER SAVE	30
SPECIAL FEATURES	31
REMOTE VIEWING VIA APP	33
RECORDING VIDEO	36
Recording	36
Viewing Recorded Video	36

Deleting Folders and Video Files	36
Viewing Recorded Video on your Computer	37
ZOOM	37
NIGHT LIGHT	37
LULLABIES	37
USING THE INTERCOM	38
CAMERA PAIRING	38
MAINTAINING YOUR SYSTEM	38
TROUBLESHOOTING	39
SPECIFICATION	40
ONE-YEAR LIMITED WARRANTY	42

WHAT'S IN THE BOX?

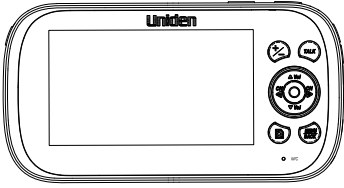

Monitor

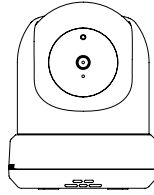

BW31PTZ
Camera

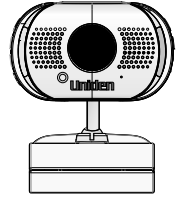

BW3000
Camera

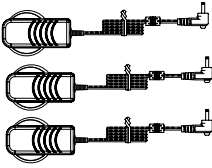

AC Adaptors

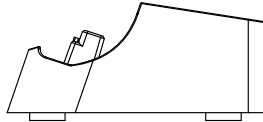

Charge/Ethernet Cradle

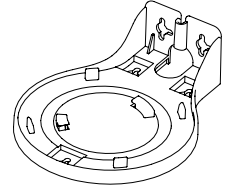

Bracket
(for BW31PTZ)

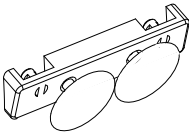

Suction Cup
Adaptor Bar

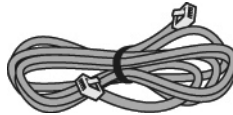

Ethernet Cable

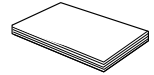

Owner's Manual



Screws & Anchors

- If any item is missing or damaged, contact your place of purchase immediately.
Never use damaged products!
- Need help? Get answers at our website:
www.uniden.com.au for Australian model

INSTALLATION

MONITOR INSTALLATION

1. Place the monitor in a location with clear reception from your camera(s).
 2. If you are using the monitor as a stand-alone unit, flip out the stand on the back of the monitor and extend the antenna. Connect an AC adaptor to the power input on the side of the receiver. If you are using the monitor with the charge/ ethernet cradle, insert it into the cradle and connect an AC adaptor to the input jack on the back of the cradle.
 3. Plug the power plug into a 240 volt AC (standard indoor) power outlet or surge protector.
 4. Press and hold the **POWER** button to turn the unit on or off. Let the monitor charge for 6 hours prior to first time use so the built-in rechargeable monitor battery is fully charged. **DO NOT** remove the power cable from the monitor/ cradle during the initial charge process. After the initial charge, recharge the monitor as needed.
 5. *Out of range* displays until you turn on the camera.
- 🔊 **We recommend that the device should be fully charged once every three months with the monitor switched off in order to prolong the device's battery life.**

CAMERA INSTALLATION

The BW31PTZ camera comes with a mounting bracket. With it installed, you can mount the camera on the wall or ceiling.

The BW3000 camera and mounting clip are a complete unit. The BW3000 camera does come with a separate suction cup bar. With it installed, you can mount the camera on glass or smooth metallic surfaces.

Placement Considerations

- The camera included with your monitor is **NOT** weatherproof; it is an indoor camera.
 - The clearest line-of-sight between the camera and monitor is best. Walls, especially brick and concrete, can affect reception quality.
 - Avoid having a direct light source in view of the camera (ceiling or floor lamps).
 - Carefully plan where and how the camera will be positioned, and where you will route the cable that connects the camera to the power adaptor.
 - When you are positioning the camera, bring the monitor along; it's much easier to get the camera into the right position when you have the display handy. Check the image on the monitor before you install the camera.
 - *Out of range* displays when the camera is out of range, turned off, or unsuccessfully paired to the monitor.
- 🔊 **You can install additional cameras (maximum of 4 cameras). When adding cameras that were not included in the original box, you will need to pair the cameras with the monitor. Refer to page 28.**

BW31PTZ Wall Mount Bracket

The BW31PTZ camera mounting bracket has slots that fit over screws to mount the bracket on the wall.

1. Mark the position of the screw holes on the wall.
2. Drill holes and insert the anchors and screws provided. Be sure to leave room for the mounting bracket to fit over the screw heads.
3. Place the mounting bracket over the installed screws and push it downwards, locking it into place.

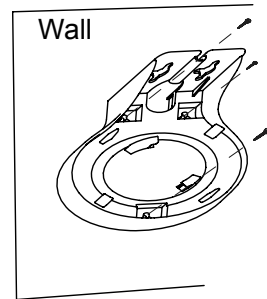
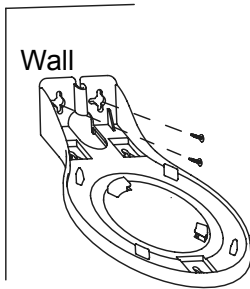

Connect Power Cable

1. Plug the AC adapter into a 240 volt AC (standard indoor) power outlet or surge protector.
2. Pull the AC adapter cable through the small space in between the two wall screws.
3. Insert the AC adaptor power plug into the camera's DC adaptor input jack.

Place the Camera on the Wall Bracket

1. Adjust the camera till it slots into the wall mount bracket.
2. Twist the camera till it properly secured to the wall mount bracket.
3. Switch the power to ON. The green light shows the camera is powered up. If it does not light up, try reconnecting the AC adaptor, making sure the power outlet is switched on.

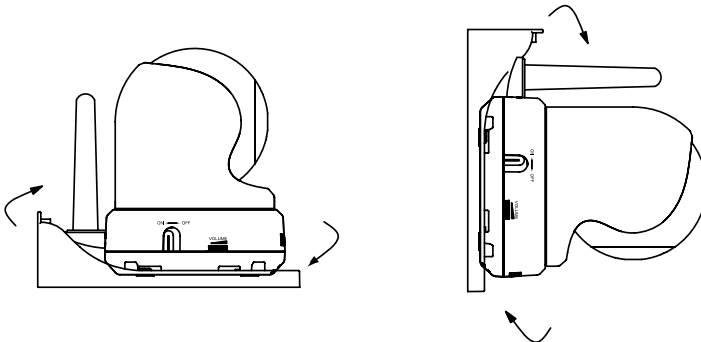

BW3000 Wall Mount

The BW3000 camera mounting clip has two slots that fit over screws to mount the unit on the wall.

1. Mark the position of the screw holes on the wall.
2. Drill holes and insert the anchors and screws provided. Be sure to leave room for the mounting clip to fit over the screw heads.
3. Place the mounting clip over the installed screws and push it downwards, locking it into place.
4. Adjust the camera as needed.

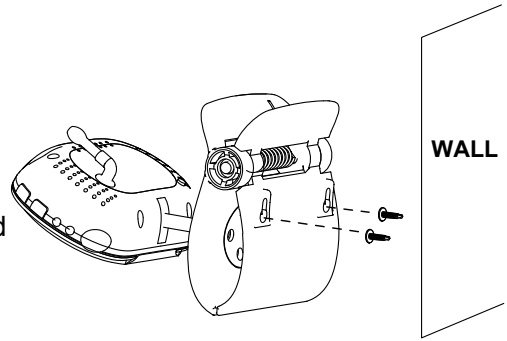

Suction Mount

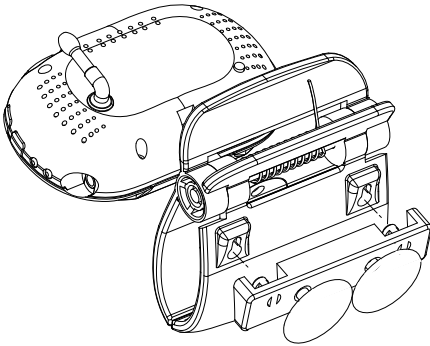

1. Insert the suction base into the mounting clip as shown.
2. Firmly press the camera with the suction base attached onto glass surface.
3. Adjust the camera as needed.

⚠️ **“Suctions will not stick well on a curved/ textured or wet surface. Make sure the spot is smooth and flat. Dry the spot completely (use a lint-free cloth, if possible).**

Clip Mount

Clip the BW3000 on ledges and shelves.

1. Press the mounting clip as shown.
2. Place the unit over the mounting surface and release.
3. Adjust the camera as needed.

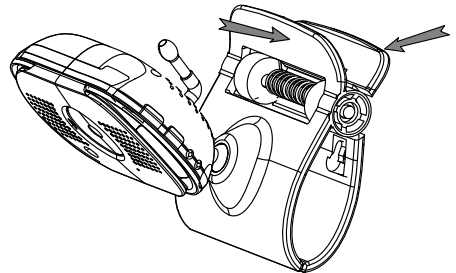

Connect Power

1. Insert the AC adaptor power plug into the camera's DC adaptor input jack.
2. Plug the other end into a 240 volt AC (standard indoor) power outlet or surge protector. The red charging LED turns on.
3. Press **POWER**. The green power LED turns on and the monitor now displays camera video. If it doesn't, try reconnecting the AC adaptor, making sure the power outlet is switched on.

BASIC OPERATION

BW31PTZ

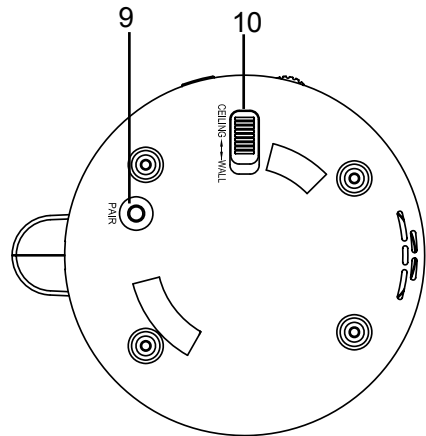
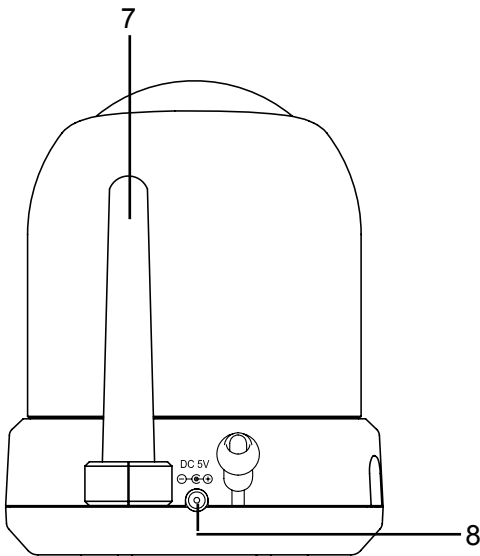
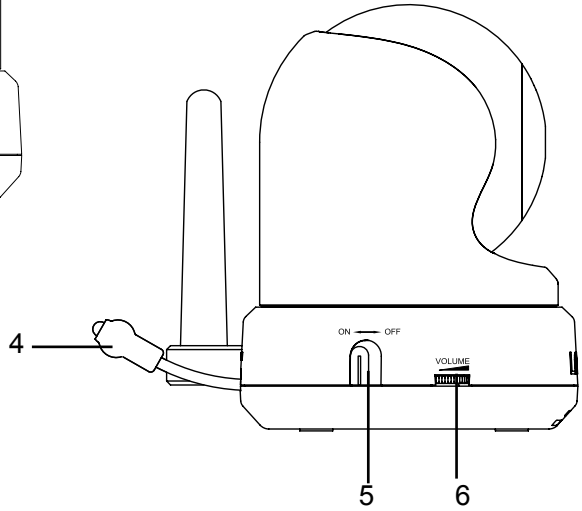
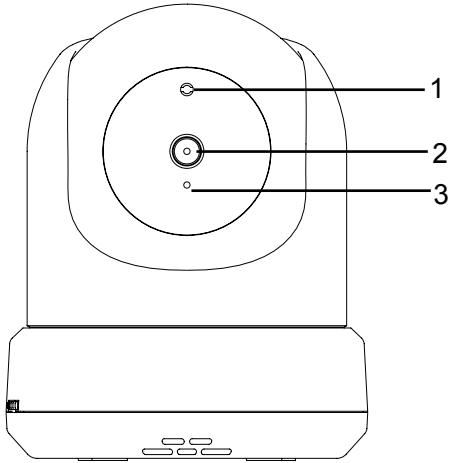

Item	What it does
1	Light sensor: Measures light intensity on the camera side.
2	Lens: Camera lens.
3	Microphone: Receives sounds for the area near the camera, and transmits sound from the camera to the monitor.
4	Temperature sensor: Detects temperature at camera side and displays it on the monitor LCD.
5	Power Switch: Turns the camera ON or OFF.
6	Volume Switch: Turn to increase or decrease volume.
7	Camera Antenna: Sends and receives signals to or from the monitor.
8	DC 5V Power: Connects the DC 5V power adaptor to the camera. *Please ensure that the correctly labelled power adaptor is used.
9	PAIR: Pairs the camera to the monitor.
10	Ceiling/Wall flip switch: Slide the switch to rotate the camera view depending on where the camera is mounted (wall or ceiling).

BW3000

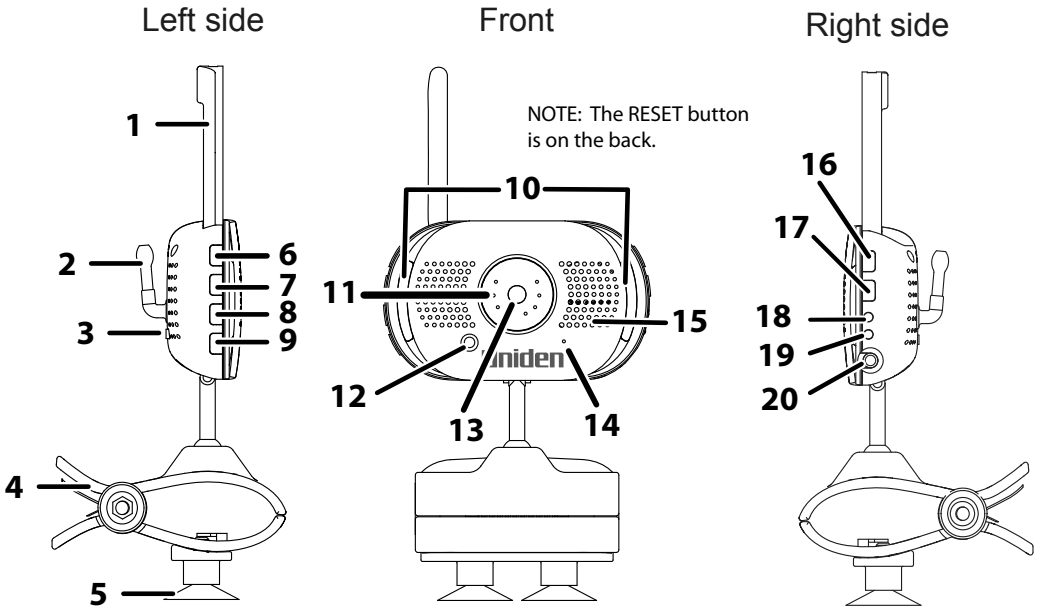

Item	What it does
1	Camera Antenna: Sends and receives signals to or from the monitor.
2	Temperature sensor: Detects temperature at camera side and displays it on the monitor LCD.
3	PAIR: Pairs the camera to the monitor.
4	Clip: This fastener can attach the camera to shelves or ledges.
5	Suction Base: Attach to mount the camera on glass or metallic surfaces.
6	▲Vol: Increase speaker volume.
7	▼Vol: Decrease speaker volume.
8	LULLABY PLAY/STOP: Press this button to play lullabies. See page 37 for details.
9	LULLABY SKIP: Press to play next lullaby. See page 37 for details.
10	LED night light bars.
11	IR LEDs (Covered): Infrared LEDs provide viewing in no/low light conditions.
12	Light sensor: Measures light intensity on the camera side.
13	Lens: Camera lens.
14	Microphone: Receives sounds for the area near the camera, and transmits sound from the camera to the monitor.
15	Speaker: Produces the sound transmitted from the monitor.
16	POWER: Turns the camera ON or OFF.
17	NIGHT LIGHT: Press to turn the night light on or off.
18	Charging LED: Red = Charging Green = Fully charged Off = Camera and power adaptor are disconnected or power adaptor is disconnected from power source.
19	Power LED: Green = Camera is turned on. Green (Blinking) = Battery is low.
20	DC 5V Power: Connects the DC 5V power adaptor to the camera. *Please ensure that the correctly labelled power adaptor is used.

WIRELESS MONITOR

NOTE: RESET button on back of monitor.

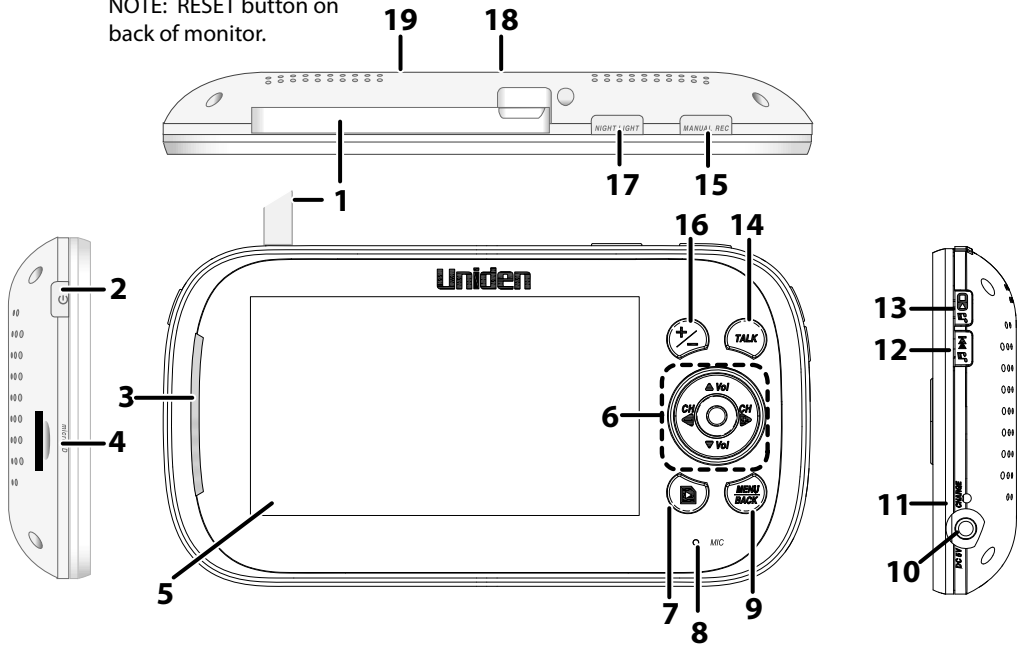

Item	What it does
1	Antenna: Receives video and audio signals from the camera.
2	POWER: Turns the monitor on and off. Please note, if connected to the charge/ethernet cradle, the monitor cannot be powered off using the POWER switch. You will have to disconnect the AC adaptor from the cradle.
3	LED light bar. The bottom LED indicates power and the remaining LEDs indicate sound.
4	MicroSD card slot: Insert microSD card to record video.
5	4.3 inch LCD screen.







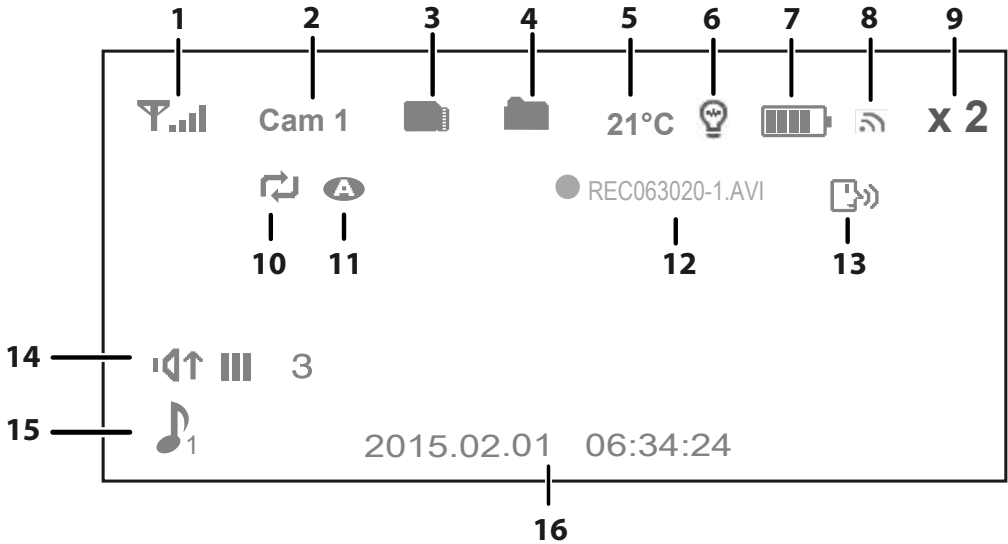



6	<p>▲Vol:</p> <ul style="list-style-type: none"> • Increase speaker volume. • In Menus: Scroll up. • In Lullaby: Increase volume. • In Zoom: Scroll up. • In Video Playback - Pause or playback. <p>CH◀:</p> <ul style="list-style-type: none"> • In Menus: Scroll left. • In Zoom: Scroll left. • In Live view: Switch between available cameras. • In Video Playback - Fast reverse. <p>▼Vol:</p> <ul style="list-style-type: none"> • Decrease speaker volume. • In Menus: Scroll down. • In Lullaby: decrease volume. • In Zoom: Scroll down. • In Video Playback - Stop playback. <p>CH▶:</p> <ul style="list-style-type: none"> • In Menus: Scroll right. • In Zoom: Scroll right. • In Live view: Switch between available cameras • In Video Playback - Fast forward. <p>Joy Stick:</p> <ul style="list-style-type: none"> • Press - To select a menu or accept a setting • Move Up/Down/Left/Right - To pan and tilt the camera. (Live and Zoom view)
7	PLAY RECORD: Access video files.
8	Microphone: Receives sound and transmits it to the camera, when the TALK button is pressed and held.
9	<p>MENU/BACK:</p> <p>Press to display the menu options.</p> <ul style="list-style-type: none"> • In Menus: Back one level. • In Video Playback: Back out of Video Playback function one screen at a time.

10	DC 5V: Connects the DC 5V power adaptor to the monitor. *Please ensure that the correctly labelled power adaptor is used.
11	Charge LED <ul style="list-style-type: none"> • Green = Battery is fully charged. • Orange = Battery is almost half charged. • Red = Battery is charging. If the monitor becomes unplugged from the adaptor, this LED turns off.
12	LULLABY SKIP: Skips to the next lullaby in the series. See page 37 for details.
13	LULLABY PLAY/STOP: Press this button to remotely play lullabies. See page 37 for details.
14	TALK: Activate Intercom function (see page 38).
15	MANUAL REC: Press to start recording manually. Press again to stop.
16	ZOOM: Displays the camera image in double size (see page 37).
17	NIGHT LIGHT – Remotely turn the night light ON or OFF for the camera currently being displayed. The monitor's night light function is only available when the camera is paired to the monitor.
18	Stand
19	Reset

LCD Display



Item	Icon	What it does																		
1		<p>Signal Indicator (displays in full screen mode only). The number of bars in the signal indicator shows the strength of the signal received from the camera. One or no bars indicates the signal is poor, and 4 bars indicate a very strong signal.</p> <table border="1"> <thead> <tr> <th>Signal Strength</th> <th>Indicator</th> <th>Warning</th> </tr> </thead> <tbody> <tr> <td>Perfect</td> <td></td> <td>None</td> </tr> <tr> <td>Good</td> <td></td> <td>None</td> </tr> <tr> <td>Fair</td> <td></td> <td>None</td> </tr> <tr> <td>Low</td> <td></td> <td>None</td> </tr> <tr> <td>No Signal</td> <td></td> <td>Out of range</td> </tr> </tbody> </table>	Signal Strength	Indicator	Warning	Perfect		None	Good		None	Fair		None	Low		None	No Signal		Out of range
Signal Strength	Indicator	Warning																		
Perfect		None																		
Good		None																		
Fair		None																		
Low		None																		
No Signal		Out of range																		
2	Cam1	<p>Camera Indicator. Indicates which camera is displaying. Press CH▶ or CH◀ on the monitor to switch between available cameras. It will cycle in the following order:</p> <p>CH▶ : CAM1—CAM2—CAM3—CAM4—QUAD—AUTO SCAN — CAM1</p> <p>CH◀ : CAM1—Auto SCAN—QUAD—CAM4—CAM3—CAM2—CAM1</p>																		
3		<p>microSD Card: This icon displays when there is a microSD card inserted into the card slot.</p>																		

4		New Record Indicator. This flashing icon indicates when a new video record is available.
5	21°C	Temperature indicator (displays in full screen mode only). Displays the temperature on the camera side.
6		Night light indicator (displays in full screen mode only). Displays when the night light is turned on. (See page 37)
7		Battery level. Indicates the amount of power left in the battery. The  icon displays when the battery is charging. The icon flickers when charging is nearly complete.
8		Remote View indicator.
9	x 2	ZOOM indicator. The zoomed image displays as the background image.
10		Overwrite indicator. When this icon displays, the overwrite function is enabled; the video monitor will overwrite old video files when the microSD card is full.
11		Auto recording indicator. This icon indicates that the recording time has been set
12	● REC 063020-1.AVI	Recording indicator. This grouping displays when video is recording. REC 063020-1.AVI - 06 = hour; 30 = minute; 20 = second; -1 = recording camera
13		Intercom (Talk). Displays in full screen mode only when you press and hold TALK on the monitor (see page 38).
14		Volume indicator. Displays when ▲Vol or ▼Vol is pressed on the monitor. If the volume is muted, X displays.
15		Lullaby (displays in full screen mode only). Displays when a lullaby is playing. The number indicates which melody is playing (see page 37).
16	2015.02.01 6:34:24	Date and Time (displays in full screen mode only). Displays the time as set through the monitor. 2013.02.01 6:34:24 = year.month.day hour:minute:second

USING THE BW3451R + 1

Viewing Modes

Live view displays live images from the cameras in the following modes:

- Quad mode: Monitor displays video from all cameras on a single screen in 4 quadrants. Any channel that does not have a camera is blank.
- Single mode: Monitor displays video from one camera at a time.
- Scan mode: Monitor displays video from one camera at a time, but cycles through all cameras one by one.

Use CH▶ or CH◀ to cycle through these modes.

✂ **Your system comes with a two cameras; therefore, it only displays in Single mode in Live view or a single quadrant in Quad view.**

To...	Do...
Change between quad view, single view, and scan for Live view	Press CH▶ to cycle through the Live modes in the following order: CAM1—CAM2—CAM3—CAM4—QUAD— AUTO Scan — CAM1
Check the temperature	The temperature displays on the monitor screen when the camera is in full screen mode.
Turn on the night light	Press NIGHT LIGHT on the top of the monitor See page 37 for details.
Set the date and time	See page 20.
Set the room temperature range for the temperature alert	See page 22, 23.
Use the Lullaby function	See page 37.
Record Video	See page 36.
Play back video	See page 36.
Delete video	See page 36.
Adjust the monitor volume	Press ▲Vol (increase volume) or ▼Vol (decrease volume) on the monitor or turn the volume switch on the camera.
Use the Intercom	1. Press and hold TALK on the monitor. 2. Speak into the microphone. 3. Release to hear reply.

SYSTEM MENUS

Press **MENU/BACK** to access system menus. Use the navigating buttons to navigate up (▲Vol), down (▼Vol), left (CH◀), and right (CH▶) in the menus, then press **JOY STICK (OK)** to confirm a setting. Use CH▶ or CH◀ to focus on the 5 different system menu selections on the clothesline.

- System
- Power Save
- Camera
- Record
- Alert

SYSTEM

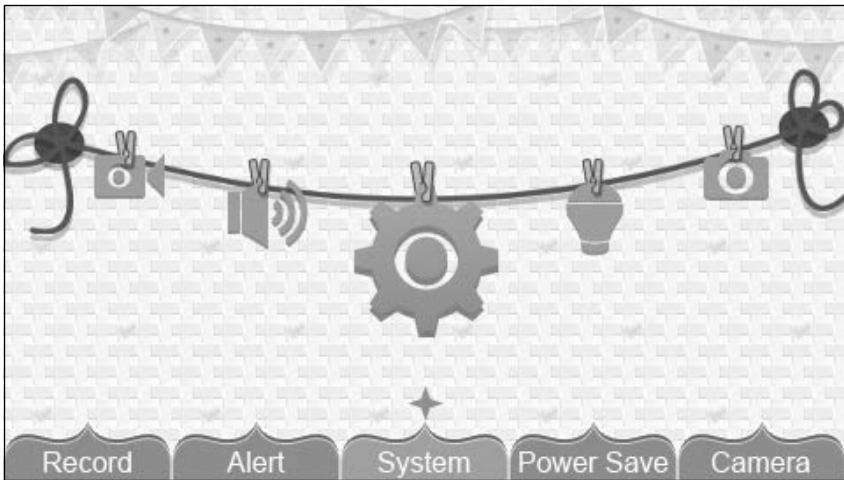

Move the focus to the System option and press **JOY STICK (OK)** to access the seven System options:

- Date/Time
- Brightness
- Format Storage
- Factory Reset
- Language
- Temp. display unit
- Temp. alert range

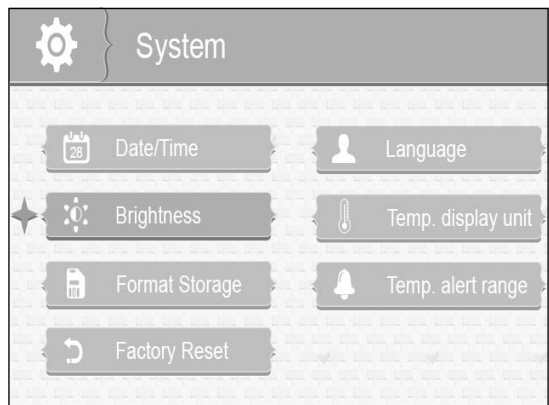

Date/Time

This option allows you to set the system date and time. The display format is Year.Month.Day Hour:Minute

1. From the System menu, select *Date/Time* and press **JOY STICK (OK)**. The *Date/Time* screen displays.



2. Press ▲Vol or ▼Vol to increase/decrease the number for that setting.
3. Press CH▶ or CH◀ to save the current setting and move to the next setting.
4. Press **JOY STICK (OK)** to save the completed date and time setting and return to the main System options. Press **MENU/BACK** to step backwards one level until you are out of the menu system.

Brightness

This option allows you to adjust the brightness level for each camera. (Default = 3)

1. From the System menu, select *Brightness* and press **JOY STICK (OK)**. The *Brightness* screen displays.



2. Press CH▶ or CH◀ to increase or decrease the brightness level (6 levels).
3. Press **JOY STICK (OK)** to save the setting and return to the main System options. The new brightness level displays the next time you are in Live view.

Format Storage

Turning on Format Storage allows you to delete the files on your microSD card. (Default = No)

1. From the System menu, select *Format Storage* and press **JOY STICK (OK)**. The *Format Storage* screen displays.
2. Press **▲Vol** or **▼Vol** to toggle between accepting or canceling the microSD card reformat.
3. Press **JOY STICK (OK)** to save the setting and return to the main System options.



Factory Reset

This option allows you to restore your system to factory setting. (Default = No)

1. From the System menu, select *Factory Reset* and press **JOY STICK (OK)**. The *Factory Reset* screen displays.
2. Press **▲Vol** or **▼Vol** to select or cancel a reset to factory defaults.
3. Press **JOY STICK (OK)** to save the setting and return to the main System options.



⚠ **All menu settings, except Camera Pairing, WILL be affected by a reset. Cameras will remain paired with the monitor.**

Language

This option allows you to select the system's display language from English, Español, or Français. (Default = English)

1. From the System menu, select *Language* and press JOY STICK (OK). The *Language* screen displays.



2. Press ▲Vol or ▼Vol to select a language.
3. Press JOY STICK (OK) to save the setting and return to the main System options.

Temperature Display Unit

This option allows you to set the temperature to display in Celsius (C) or Fahrenheit (F). (Default = C)

1. From the System menu, select Temp. display unit and press JOY STICK (OK). The *Temp. display unit* screen displays.

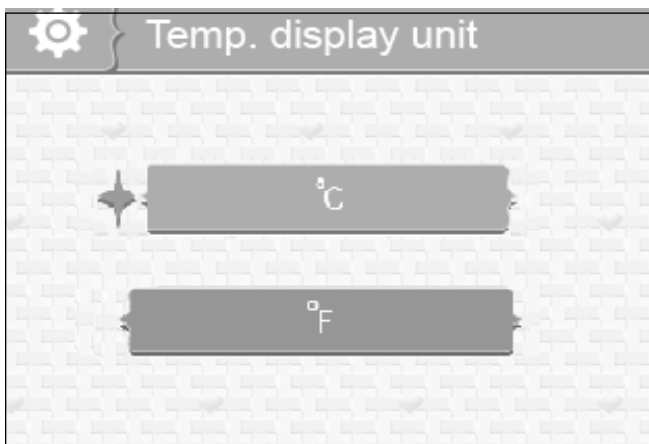

2. Press ▲Vol or ▼Vol to select °C or °F.
3. Press JOY STICK (OK) to save the setting and return to the main System options.

Temperature Alert Range

Your BW3451R+1 able to provide ambient room temperature around the camera as a reference only. If the temperature falls outside of a preset range, the system alerts you. Temperature alert range lets you set that range. [Default = Low Temperature: 16°C ; High Temperature: 25°C; Off]

1. From the System menu, select *Temp. alert range* and press **JOY STICK (OK)**. The *Temp. alert range* screen displays.

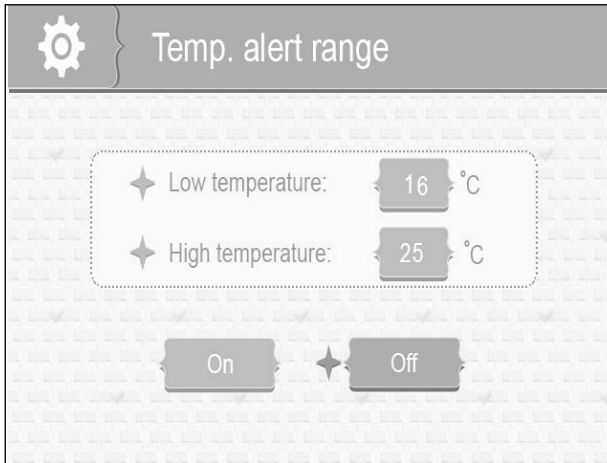

2. Press CH▶ or CH◀ to select Low temperature or High temperature
3. Press ▲Vol or ▼Vol to increase or decrease the temperature value.
4. After setting the temperature range, press CH▶ or CH◀ to select the On/Off row.
5. Press CH▶ or CH◀ to toggle between On (Enable) or Off (disable). Either button will work.
6. Press **JOY STICK (OK)** to save the settings and return to the main System options.

⚠ **Please note that the temperature indicated in this way should be used only as a reference, not as an accurate measurement. For a proper measurement, please use a thermometer.**

ALERT

An alert triggers when either the temperature or the cameras go out of range. This option allows you to set the alert volume. There are 6 levels available. [Default = Zero (Mute)]

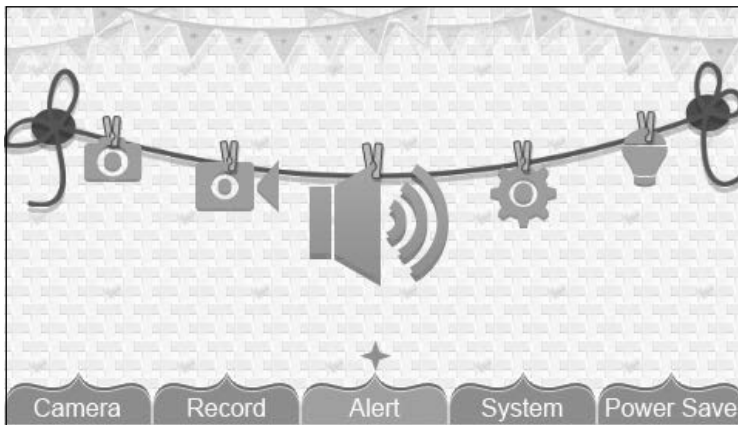

1. From the main menu selections, select *Alert* and press **JOY STICK (OK)**. The *Alert Volume* screen displays.

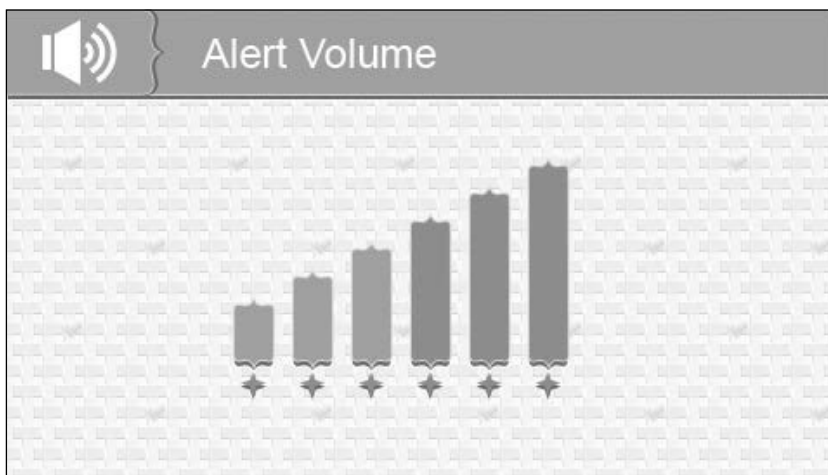

2. Press **CH▶** or **CH◀** to adjust the volume.
3. Press **JOY STICK (OK)** to save the selection and return to the main menu selections.

RECORD

This option allows you to set the parameters for your recorded files.

The RECORD options are:

- Quality
- Record Time
- VOX
- Overwrite



Quality

This option allows you to choose between a high or low resolution recording quality. (Default = Low 320 x 240)

1. From the Record menu, select *Quality* and press **JOY STICK (OK)**. The *Quality* screen displays.



2. Press **▲Vol** or **▼Vol** to select a level (High or Low).
3. Press **JOY STICK (OK)** to save the selection and return to the main RECORD options.

Record Time

This option allows you to select how long the camera will record when the VOX sensitivity function is activated. (Default = 30 secs.)

1. From the Record menu, select *Record Time* and press **JOY STICK (OK)**. The *Record Time* screen displays.



2. Press **▲Vol** or **▼Vol** to select a recording time block.
3. Press **JOY STICK (OK)** to save the selection and return to the main RECORD options.

VOX

VOX (Voice Activation) allows you to set the sound sensitivity for the camera. (Default = High). In Power Save mode, this function will turn on the LCD screen momentarily when sound is detected by one of the camera microphone during scan or quad mode.

1. From the Record menu, select *VOX* and press **JOY STICK (OK)**. The *VOX sensitivity* screen displays.

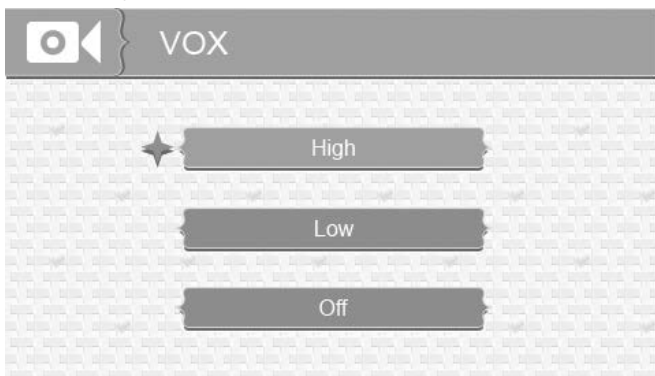

2. Press **▲Vol** or **▼Vol** to select a level (High, Low, or Off).
3. Press **JOY STICK (OK)** to save the selection and return to the main RECORD options.

Overwrite

Activating this function allows the oldest files to be deleted when you want to record but the microSD card is full.

1. From the Record menu, select *Overwrite* and press **JOY STICK (OK)**. The *Overwrite* screen displays. (Default = No)



2. Press **▲Vol** or **▼Vol** to toggle between *Yes* and *No* to activate or deactivate this feature.
3. Press **JOY STICK (OK)** to save the selection and return to the main RECORD options.

Please use well-known brands of microSD cards to avoid operation errors.
The BW3451R+1 supports up to 32GB microSD cards.

CAMERA

This option allows you to pair the monitor with cameras (up to 4 cameras supported) to turn on/off individual camera. The cameras are still powered on but no longer visible to the monitor.

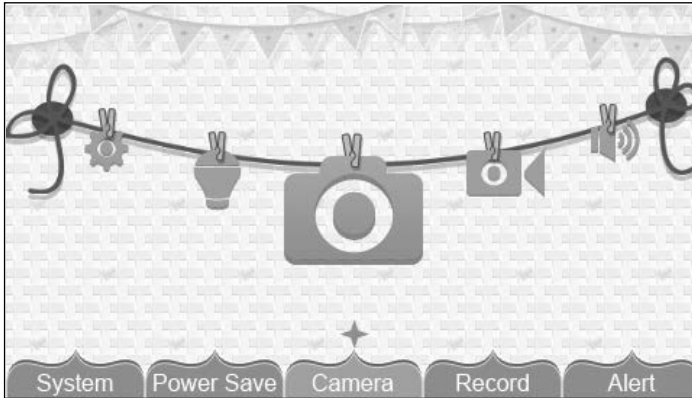

1. From the main menu selections, select *Camera* and press **JOY STICK (OK)**.
2. The *Camera options* screen displays. Two options display: Pair and On/Off. (Default =Pair)

Pair

Pairing allows you to introduce additional cameras to the monitor. The monitor can then recognize and display video from them. The camera that comes with this system is already paired. (Default = Camera 1)

⚠ **Before pairing additional cameras, be sure they are powered and turned on.**

1. Select *Pair* from the Camera options screen. The camera selection screen displays.



2. Press ▲Vol or ▼Vol to select the camera you want to pair, then press **JOY STICK (OK)**. The monitor prompts you to press the **PAIR** button on the bottom of the camera within 30 seconds.
3. Press **PAIR** button on the bottom of the camera within 30 seconds.
4. That camera's video displays on the monitor when pairing is successful.

🔊 **Pair the cameras to the monitor before mounting them.**

On/Off

This option allows you to turn individual cameras on/off so their video is not visible through the monitor. (Default = Camera 1 - On; Cameras 2 - 4 - Off)

1. Select On/Off from the Camera options screen. The On/Off screen displays.



2. Press ▲Vol or ▼Vol to select a camera.
3. Press CH▶ or CH◀ to toggle between *On* and *Off* for that camera. Either button will work.
4. Press ▲Vol or ▼Vol to select another camera.
5. Press **JOY STICK (OK)** to accept that setting and return to the Camera options screen.

POWER SAVE

Activating the Power Save feature turns off the LCD after two minutes of inactivity. Be sure that VOX is activated. However (see page 26), if VOX is deactivated, press any button on the monitor to turn the LCD back on. This option allows you to enable or disable this function. (Default = Off)

Voice Activation (VOX) will turn the LCD back on. Even with the LCD off, the LED light bar is still active.

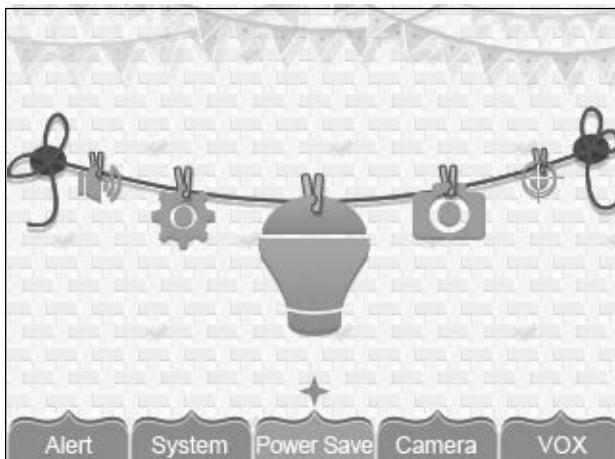

1. From the main menu selections, select *Power Save* and press **JOY STICK (OK)**. The *Power Save* screen displays.

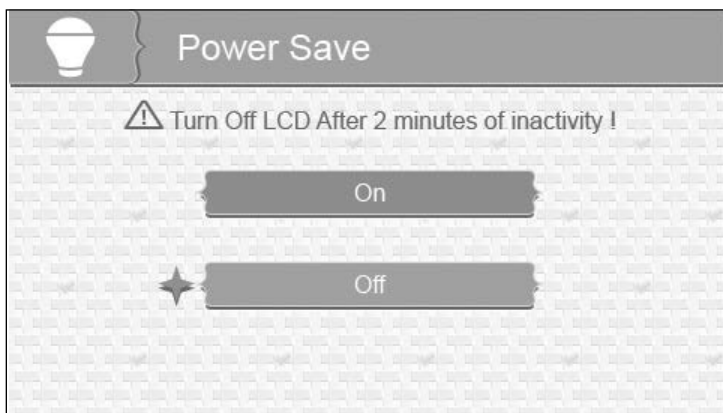

2. Press **▲Vol** or **▼Vol** to toggle between turning the Power Save feature on or off.
3. Press **JOY STICK (OK)** to accept that setting and return to the main menu selections.

SPECIAL FEATURES

REMOTE VIEWING VIA APP

You can download Uniden Baby Watch app to remotely view the system.

1. Connect the AC adaptor to the power port on the cradle and the power outlet.
2. Connect the cradle to the router using the ethernet cable (provided).
3. Place the monitor on the cradle.
4. Download the Uniden BabyWatch app from the AppStore or Google Play.
The Baby Watch app supports:
iPhone®/iPad®: iOS v.7.0 and above.
Android™: Android™ v.4.2 and above.
5. Tap the app to launch it. You will get the following screen.



6. Tap on the option, *Add Device*.
You have the option to either add the device manually or you can scan the QR code.

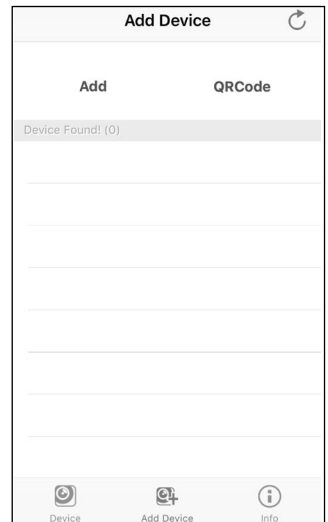

7. If you want to manually add the device tap on the option, *Add*, to get the screen shown below.
8. Tap on the *Name* field, and enter a name for your system.
9. Tap on the *UID* field and enter the UID code found on the cradle.
10. Enter the default password '000000', and then tap *Save*.

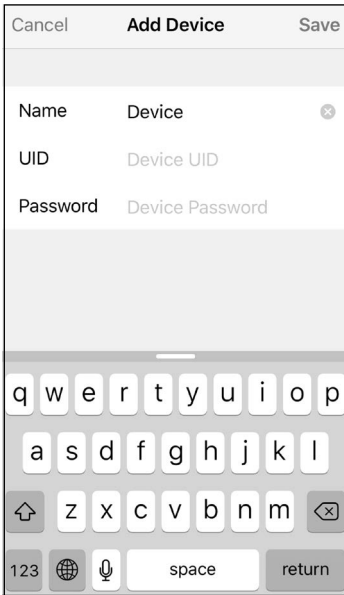

11. You could opt to scan the *QR Code* too, in that case, tap the option *QR Code* or *Scan* on the *Add Device* screen.
12. The screen shown above, displays. Position the QR Code (found on the side of the cradle) within the viewfinder rectangle to scan.
13. The *Add Device* screen displays with the UID code in the field. Enter the default password, 000000, and tap *Save* or *OK*. The *Device List* screen displays. Tap on the image to get Live View.

The following will NOT work, when the BW3451R+1 system is being viewed remotely:

- Auto-Scan
- Quad view
- Recording
- All buttons on the monitor (except Vol up and Vol down, which is used to change camera channel)
- Audio in Live View (except Alert beep).



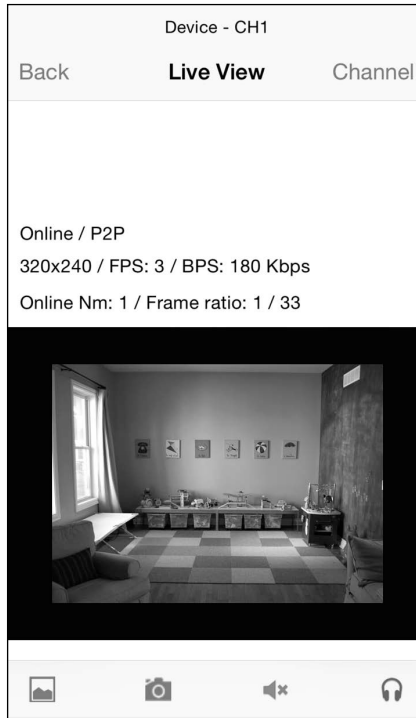

✗ **However, the user can change the channel and adjust the angle of the camera remotely.**

Live View

From the *Device List* screen, tap on the snapshot view to display the Live View.



In Live View, swipe across the screen to pan and tilt the camera.

Icon/Option	Function
	Tap on this icon to view the saved snapshots.
	Tap to take a snapshot in Live View.
	Tap to turn off audio.
	Tap to turn on audio.
Channel	Tap to view from a different camera/channel.
Back	Tap to go to the previous screen.

Advanced Settings

Password

Uniden strongly recommends changing the default password to a more personalised one.

After your device displays on your *Device List* screen, tap on the  icon to access the *Edit Device* screen.

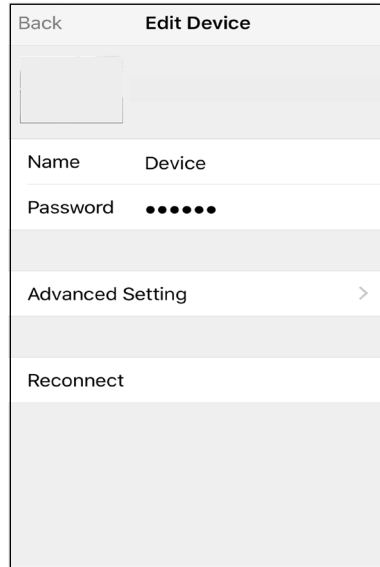
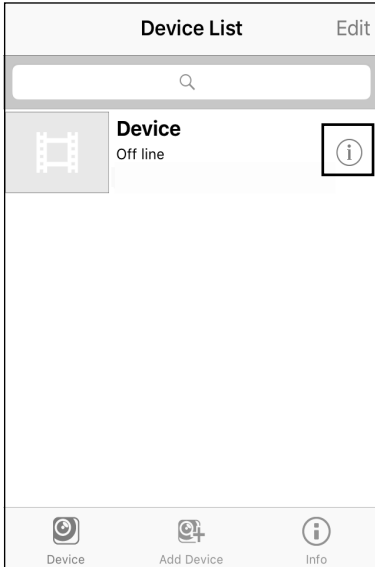

Tap on the *Advanced Setting* option to display the *Advanced Setting* screen below. Tap on the *Change Password* option to key in and confirm the new password.

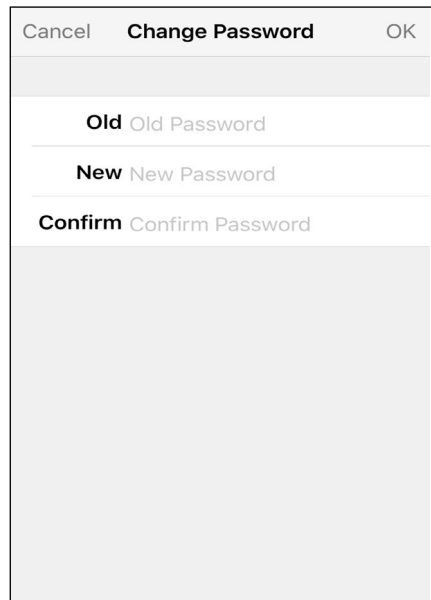
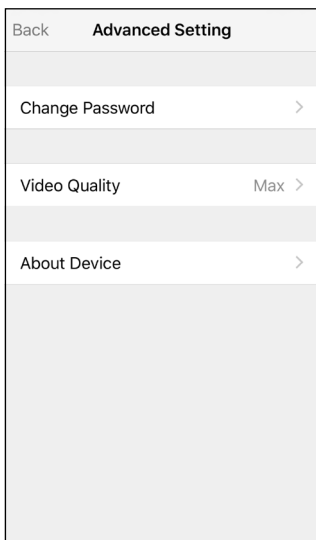

Video Quality

On the *Advanced Setting* screen, tap the option, *Video Quality*, to select the resolution of the video. The option available are: Max, High, Medium, Low, Min.

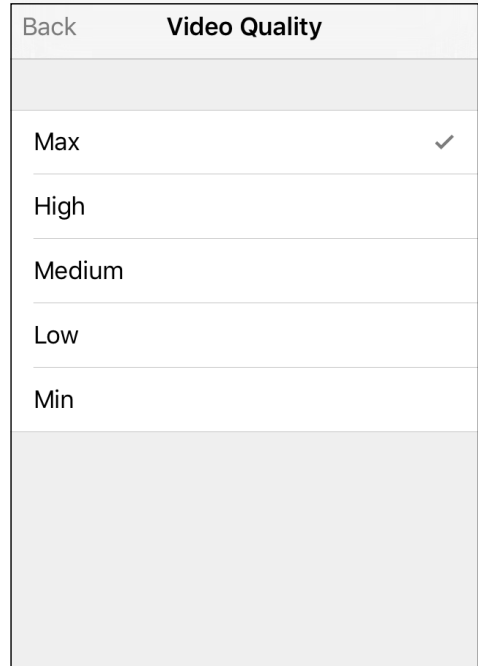
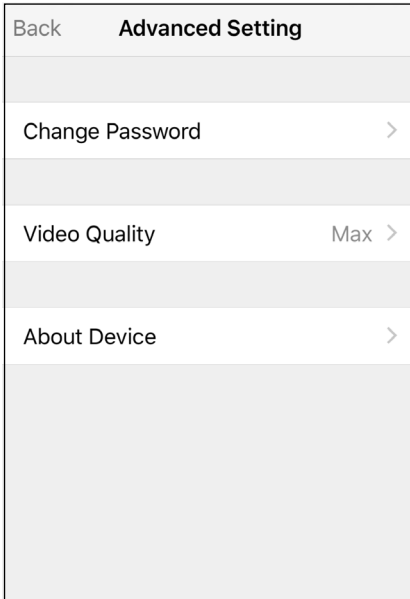

About Device

On the *Advanced Setting* screen, tap the option, *About Device*, to view the model name and firmware version.

RECORDING VIDEO

You can manually record video to a microSD card (not included). The BW3451R+1 supports up to 32GB microSD card. The system records video in 10 minute blocks; however, you can manually stop recording at any time.

⚠ **During recording, only TALK and Manual Record is active. All other buttons are disabled.**

Recording

Be sure a microSD card is inserted into the microSD card slot.

1. Press **MANUAL REC** on the monitor. The recording indicator displays.
2. Press **MANUAL REC** again to cancel manual recording.

⚠ **The New Record icon flashes red when the microSD card is full. Either manually delete video records (see below), enable Overwrite (page 27), or reformat the microSD card to delete all records (page 21).**

Viewing Recorded Video

1. Press **PLAY RECORD** to enter the **PLAY FILE** list.
2. Select the Video folder and press **JOY STICK (OK)**.
3. That folder contains other folders sorted by date (Format = YYYYMMDD). For example: 20150330 means the videos in this folder are recorded on 2015, 30th March. Press **▲Vol** or **▼Vol** to select a folder you want to view and press **JOY STICK (OK)** to open that folder and browse the files inside. Scroll down to see a complete list of folders or recorded files if needed.
4. Inside that folder are record files, sorted by time. For example: 123030-1 means the video is recorded at 12:30:30 and from camera 1.
5. Select the video you want to view and press **JOY STICK (OK)**. The video plays on the LCD screen.
6. Use the following buttons to manage the video:
 - **▲Vol** - Pause, resume video
 - **▼Vol** - Stop
 - **CH▶** - Fast forward (up to x16 speed)
 - **CH◀** - Reverse (up to x16 speed)
 - **MENU/BACK** - Back out of the video playback function, one screen at a time.

Deleting Folders and Video Files

You can delete a specific video record or an entire folder of records. As you scroll through folders, you will see a red "X" to the right of folders and video records on the **PLAY FILE** screen.

1. Press **CH▶** to highlight the red "X" beside the folder or record you want to delete. Press **JOY STICK (OK)**.
2. A confirmation screen displays. Use **CH▶** or **CH◀** to select Yes. Press **JOY STICK (OK)**.
3. The system returns to the same screen where you can see that the folder or record has been deleted.

Viewing Recorded Video on your Computer

The microSD card saves video records in AVI format. You can take that card and play it on your computer. You will need a microSD card and adaptor (not included) or an SD card reader for other systems (not included).

1. Remove microSD card from the monitor. Place it in the adaptor and insert adaptor into your PC.
2. Navigate to the SD card on your system.
3. Select the files you want to view and click Open.
4. The files begin playing, in order, through your default media player.

ZOOM

Press **ZOOM** to display the camera image in double size. Press ▲Vol, ▼Vol, CH▶, or CH◀ to see the parts of the image not displayed on the LCD screen. Press **ZOOM** again to return to normal view.

NIGHT LIGHT

You can control the BW31PTZ and BW3000 night light using the **NIGHT LIGHT** button on the top of the monitor. However, to control it from the monitor, you must place that camera in full screen mode.

1. To turn the night light on from the monitor, place the night light camera in full screen mode.
2. Press **NIGHT LIGHT** on the top of the monitor. The camera's night light turns on and a night light icon displays on the monitor.
3. Press **NIGHT LIGHT** again to turn it off.

LULLABIES

Your system comes with four preprogrammed lullabies. You can control play, stop or skip the lullabies from the monitor. However, to control the lullabies from the monitor, the camera you want to play them through must be in full screen mode.

The Lullaby feature will play all lullabies one after the other. Press **LULLABY PLAY/STOP** to turn on the Lullaby system and begin playing Lullaby #1. It will play Lullaby #1 -> Lullaby #2 -> Lullaby #3 -> Lullaby #4 -> Lullaby #1 and then cycles through all lullabies again.

Press ▲Vol and ▼Vol on the monitor or camera to adjust the volume. Press ▼Vol all the way down on the monitor to mute the lullaby playing through the monitor.

USING THE INTERCOM

The Intercom feature lets you talk to whomever is within camera range.

1. Decide which camera you want to establish an intercom link with, and make it the full screen live view camera.
2. Press and hold **TALK** the monitor.
3. Speak clearly into the microphone.
4. Release **TALK** to listen to the response.

CAMERA PAIRING

The system comes with one camera that has already been paired. It will communicate with the monitor when it is powered on.

The pairing function lets you add up to 3 additional cameras to your system. It also lets you re-pair your first camera if needed.

🔊 **Pair the cameras to the monitor before mounting the cameras.**

1. Verify that the monitor is powered on (see page 13).
2. Install and power on the accessory cameras according to the procedures beginning on page 7.
3. Pair the accessory cameras according to the procedures on page 28.
4. Once the camera has been paired, it can be viewed on the monitor.

MAINTAINING YOUR SYSTEM

Monitor

As you use your monitor, keep the screen clean by wiping it with a microfiber cloth to remove fingerprints, dust, etc.

Camera

When dust and grime builds up on the camera lens and glass, it affects the camera's "vision." Use a microfiber cloth to regularly clean the cameras or when night vision video is cloudy or unclear.

TROUBLESHOOTING

If you have problems with the system, there is often a quick and simple solution. Please try the following:

If	Try
There is no picture from the camera	<ul style="list-style-type: none"> • checking all connections to the camera. Make sure the adaptor is plugged in. • making sure that the cameras and monitor are both ON. • making sure that the camera is in range of the monitor.
The picture keeps dropping	<ul style="list-style-type: none"> • moving the camera closer to the monitor. • repositioning the camera, monitor or both to improve the reception. • adjusting the monitor and camera antennas to vertical position.
There are audio problems	<ul style="list-style-type: none"> • making sure that there is sound within range of the camera microphone. • moving the camera or monitor farther apart if the unit emits a loud screeching noise.
There is an irregular beeping coming from the monitor	That is the Alert tone. Go to the Alert screen to turn the alert volume down or off (see page 24).
The picture has become choppy	<p>The picture may become choppy when experiencing a lower frame rate. Try:</p> <ul style="list-style-type: none"> • moving the camera closer to the monitor. • removing obstructions between the monitor and camera. • adjusting the monitor and camera antennas to vertical position.
The monitor picture has frozen	Use a blunt object like an unbent paper clip to press RESET and reset the monitor. The monitor turns off. Press POWER to turn it back on again.
You can't record video (the New File icon is flashing red)	The New Record icon flashes red when the microSD card is full. Either manually delete video records (see page 36), enable Overwrite (see page 27), or reformat the microSD card to delete all records (see page 21).

SPECIFICATION

GENERAL

	Camera	Monitor
Operating Frequency Range	2.400 ~ 2.4835GHz	
TX Power	15dBm	NA
RX Sensitivity	NA	-81dBm
Type of Spread Spectrum Used	FHSS	
Type of Modulation Used	GFSK	
Communication Range	150ms Line of Sight	

BW31PTZ

Image Sensor Type

Manufacturer/ Model # 1/6.5" Color CMOS Image sensor

Effective Pixel	640 x 480
Image Processing	MJPEG
Lens	3.0mm / F2.8
Exposure	Auto
White Balance	Auto
Power Requirement	5.0VDC / 1.0mA+
Power Consumption	300mA Max (IR OFF) 450mA Max (IR ON)
Operating Temperature Range	-10°C ~ 40°C (14°F ~ 104°F)
Operating Humidity Range	Within 80% Relative Humidity
Housing Material	Plastic

BW3000

Image Sensor Type

Manufacturer/ Model # 1/6.5" Color CMOS Image sensor

Effective Pixel	640 x 480
Image Processing	MJPEG
Lens	3.0mm / F2.8
Exposure	Auto
White Balance	Auto
Power Requirement	5.0VDC /1.0 mA
Power Consumption	150mA Max (IR OFF) 730mA Max (IR ON) 440mA Max (Charging)
Operating Temperature Range	-10°C ~ 40°C (14°F ~ 104°F)
Operating Humidity Range	Within 80% Relative Humidity
RoHS Compliance	Yes
Housing Material	Plastic

MONITOR

Display Size/Type	4.3" TFT LCD
Resolution	480 x 272
Power Requirement	5.0VDC 1.5mA
Power Consumption	350mA Max (Normal) 700mA Max (Charging)
Operating Temperature Range	-10°C ~ 40°C (14°F ~ 104°F)
Operating Humidity Range	Within 80% Relative Humidity
Battery Life	up to 3 hours
Housing Material	Plastic

ONE-YEAR LIMITED WARRANTY

BW3451R+1 Series

IMPORTANT Satisfactory evidence of the original purchase is required for warranty service. Please refer to our Uniden website for any details or warranty durations offered in addition to those contained below.

Warrantor

The warrantor is Uniden Australia Pty Limited ABN 58 001 865 498 (“Uniden Aust”).

Terms of Warranty

Uniden Aust warrants to the original retail purchaser only that the BW3451R+1 (“the Product”), will be free from defects in materials and craftsmanship for the duration of the warranty period, subject to the limitations and exclusions set out below.

Warranty Period

This warranty to the original retail purchaser is only valid in the original country of purchase for a Product first purchased either in Australia or New Zealand and will expire, as indicated below, from the date of original retail sale.

Product	1 Year
Accessories	90 Days

If a warranty claim is made, this warranty will not apply if the Product is found by Uniden to be:

- (A) Damaged or not maintained in a reasonable manner or as recommended in the relevant Uniden Owner’s Manual;
- (B) Modified, altered or used as part of any conversion kits, subassemblies or any configurations not sold by Uniden Aust;
- (C) Improperly installed contrary to instructions contained in the relevant Owner’s Manual
- (D) Repaired by someone other than an authorized Uniden Repair Agent in relation to a defect or malfunction covered by this warranty; or
- (E) Used in conjunction with any equipment, parts or a system not manufactured by Uniden.

Parts Covered

This warranty covers the Product and included accessories.

User-generated Data

This warranty does not cover any claimed loss of or damage to user-generated data (including but without limitation phone numbers, addresses and images) that may be stored on your Product.

Statement of Remedy

If the Product is found not to conform to this warranty as stated above, the Warrantor, at its discretion, will either repair the defect or replace the Product without any charge for parts or service. This warranty does not include any reimbursement or payment of any consequential damages claimed to arise from a Product's failure to comply with the warranty.

Our goods come with guarantees that cannot be excluded under the Australian Consumer Law. You are entitled to a replacement or refund for a major failure and for compensation for any other reasonably foreseeable loss or damage. You are also entitled to have the goods repaired or replaced if the goods fail to be of acceptable quality and the failure does not amount to a major failure.

This warranty is in addition to and sits alongside your rights under either the COMPETITION AND CONSUMER ACT 2010 (Australia) or the CONSUMER GUARANTEES ACT (New Zealand) as the case may be, none of which can be excluded.

Procedure for Obtaining Warranty Service

Depending on the country in which the Product was first purchased, if you believe that your Product does not conform with this warranty, you should deliver the Product, together with satisfactory evidence of your original purchase (such as a legible copy of the sales docket) to Uniden. Please refer to the Uniden website for address details. You should contact Uniden regarding any compensation that may be payable for your expenses incurred in making a warranty claim. Prior to delivery, we recommend that you make a backup copy of any phone numbers, images or other data stored on your Product, in case it is lost or damaged during warranty service.

UNIDEN AUSTRALIA PTY LTD

Phone number: 1300 366 895

Email address: custservice@uniden.com.au

Uniden®

©2016 Uniden Australia Pty Ltd
Printed in PRC